



**Field Notes for Installation:**

12' back from tree that's just after driveway to private lot.

Pole Site Location E/S Main St opposite Assiniboine Av

Sign Panel	Panel Type
<b>MN1-U</b>	<b>B logo</b>
<b>MN1-L</b>	<b>D lower</b>
Pole Type	<b>B+D</b>

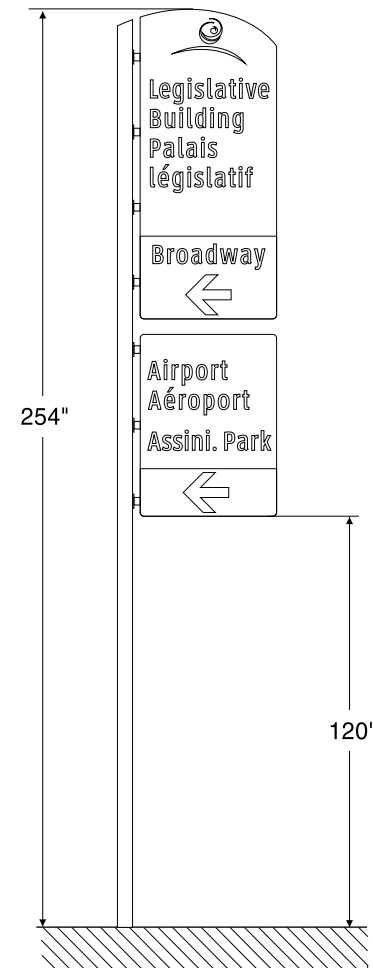



Pole Site Location E/S Main St north of Broadway

Sign Panel	Panel Type
<b>MN2</b>	<b>D "P"</b>

Pole Type **D**

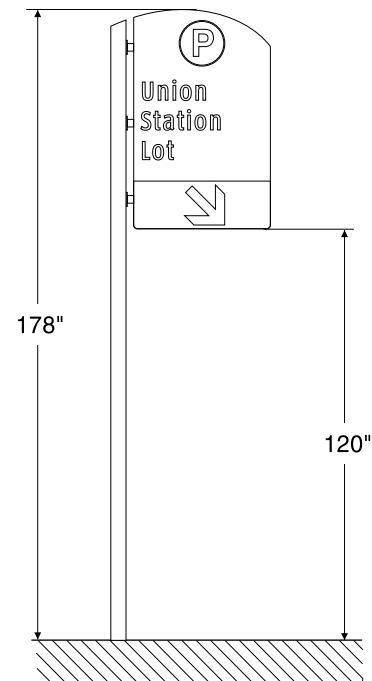

**Field Notes for Installation:**

In dirt to right of sidewalk just beyond lot entrance, \$2/hr.

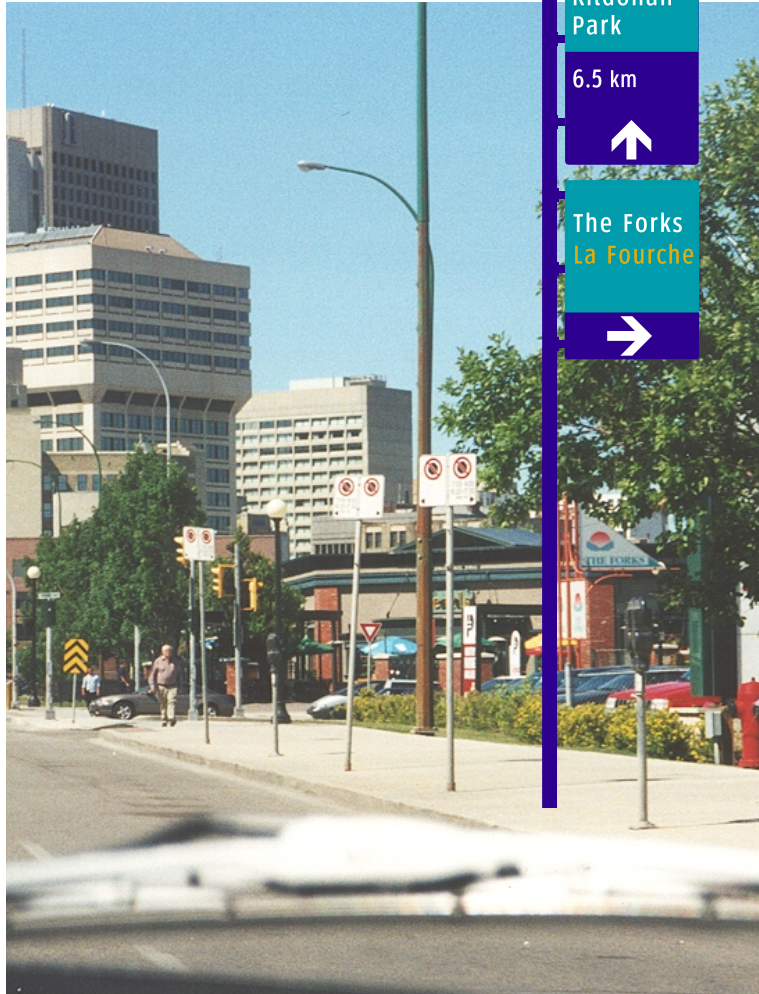

**Field Notes for Installation:**

150' back from black light pole, at turn-in before 3rd "No Parking" sign back between trees.

Pile Site Location E/S Main St south of York Av

Sign Panel	Panel Type
<b>MN3-U</b>	<b>C logo</b>
<b>MN3-L</b>	<b>D lower</b>
Pole Type	<b>C+D</b>

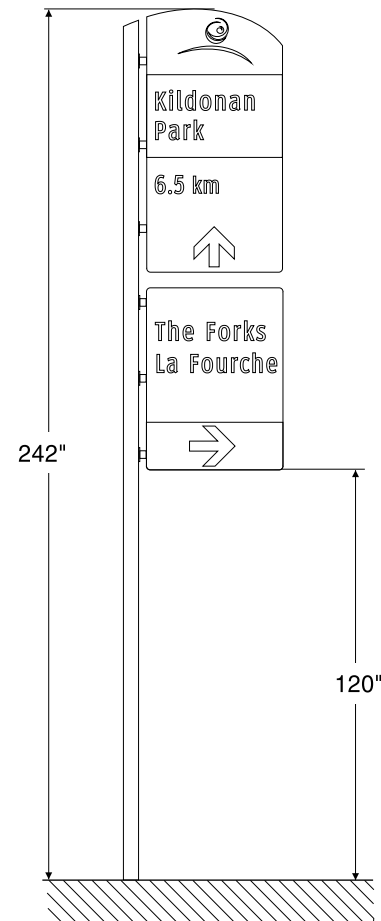



**Field Notes for Installation:**

At 1st parking meter beyond 1st drive to Earls.

Pole Site Location E/S Main St north of York Av

Sign Panel	Panel Type
<b>MN4</b>	<b>B "P"</b>

Pole Type **B**

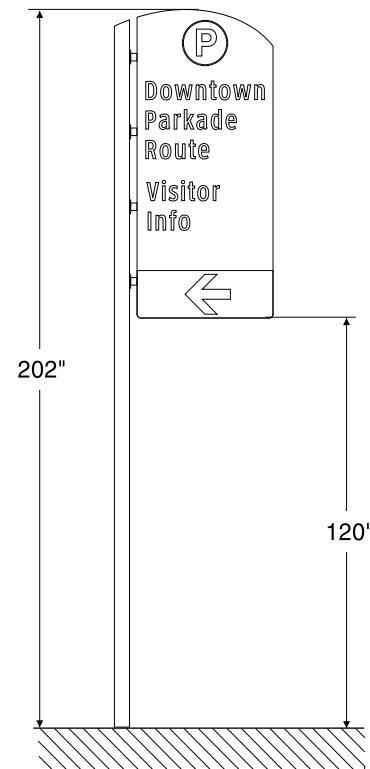

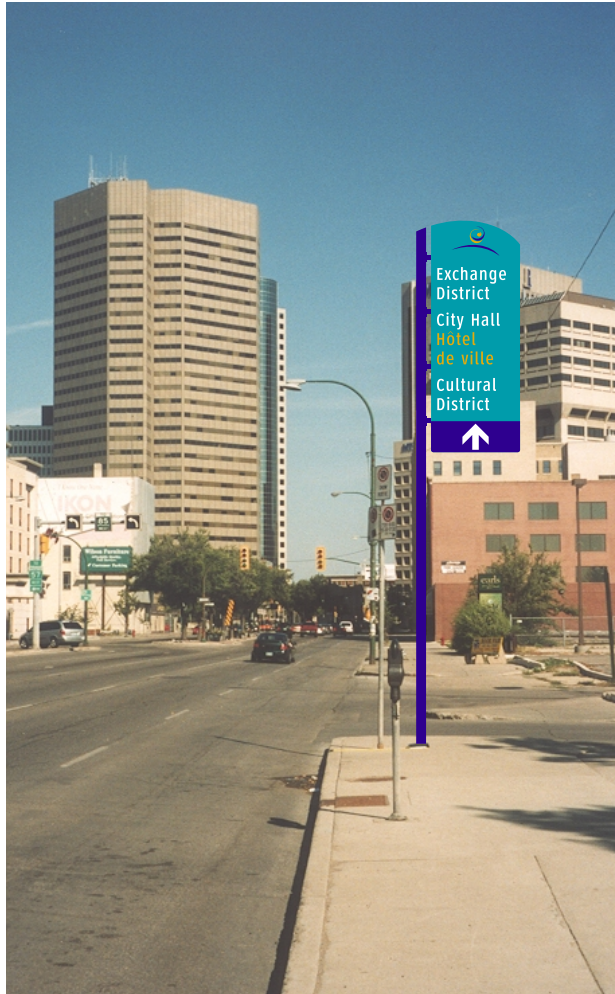

**Field Notes for Installation:**

94' past sign below, at last sign before 2nd drive-in to Earls.

Pole Site Location E/S Main St south of St Mary Av

Sign Panel Panel Type

**MN5** **A logo**

Pole Type **A**

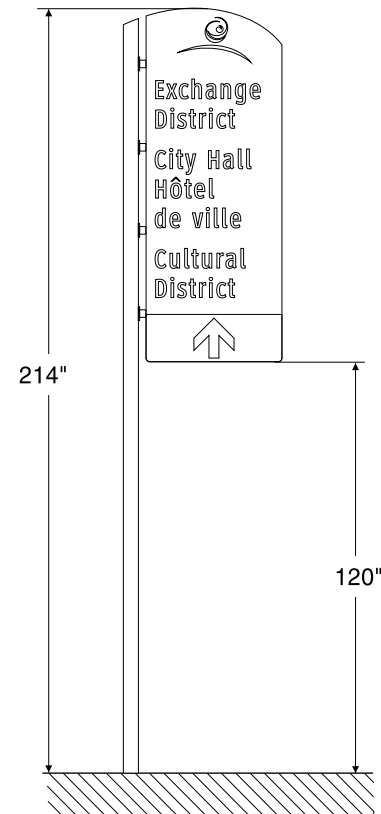

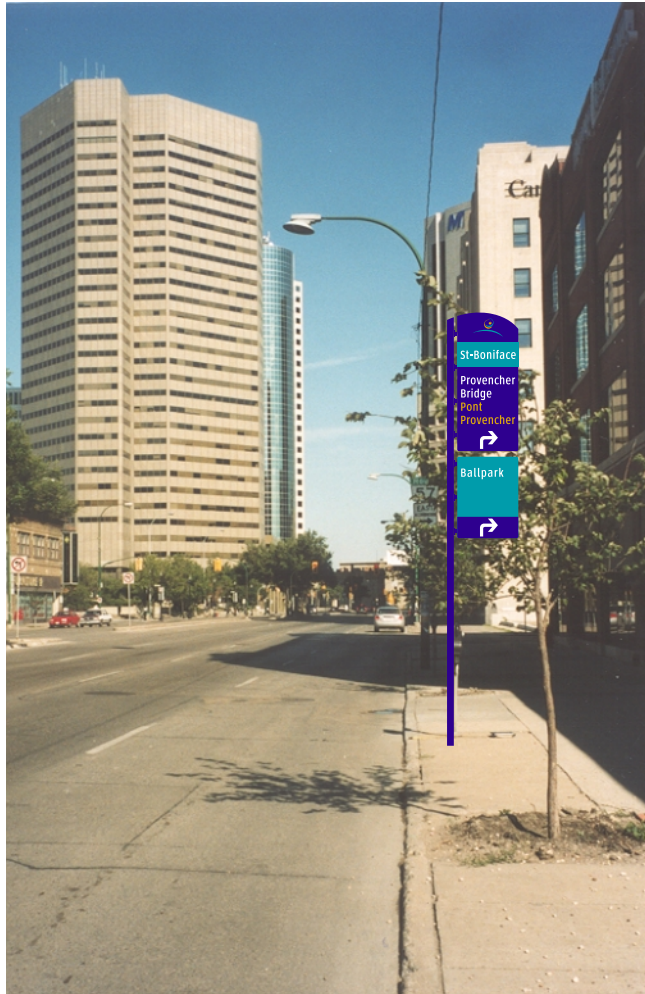

**Field Notes for Installation:**

At parking meter near door to 245 Main, 44' back from 57 West sign pole — watch wires above, may require bigger set-back.

Pole Site Location E/S Main St opposite Graham Av

Sign Panel	Panel Type
<b>MN6-U</b>	<b>B logo</b>
<b>MN6-L</b>	<b>D lower</b>
Pole Type	<b>B+D</b>

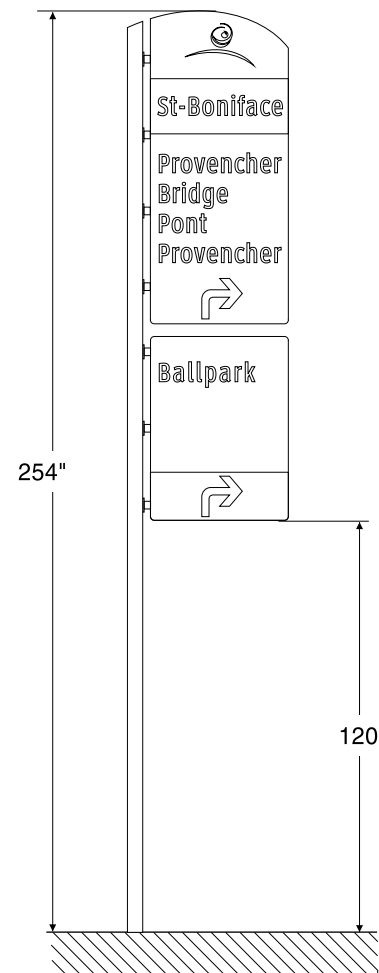



**Field Notes for Installation:**

25' back from black lamp post closest to Lombard.

Pole Site Location E/S Main St S/S of Lombard

Sign Panel Panel Type

**MN7** **C "P"**

Pole Type **C**

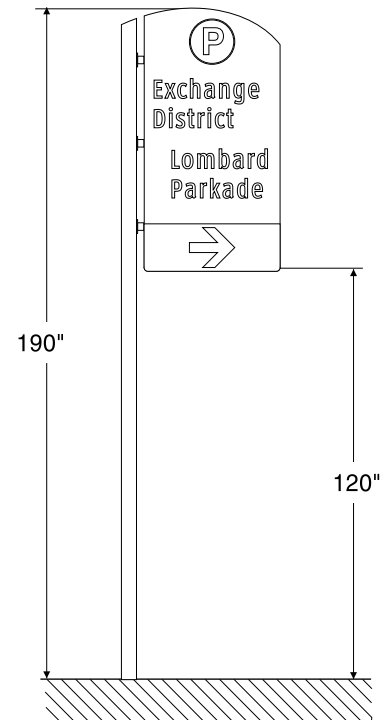

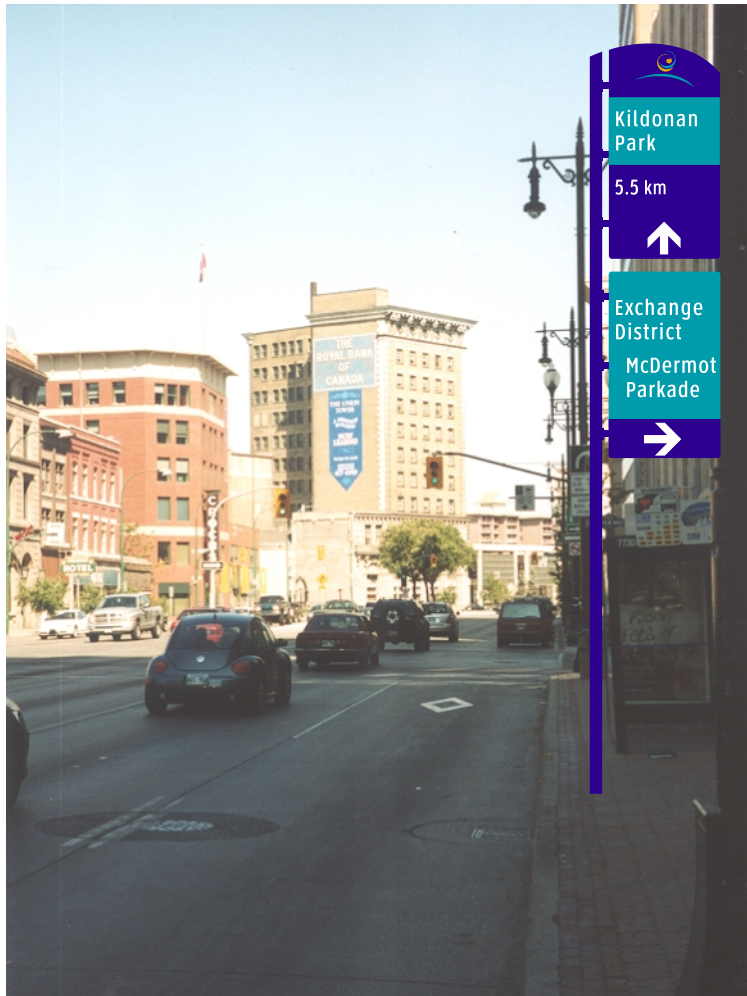

**Field Notes for Installation:**

Just before bus shelter before McDermot.

Pile Site Location E/S Main St north of Lombard Av

Sign Panel	Panel Type
<b>MN8-U</b>	<b>C logo</b>
<b>MN8-L</b>	<b>C lower</b>
Pole Type	<b>C+C</b>

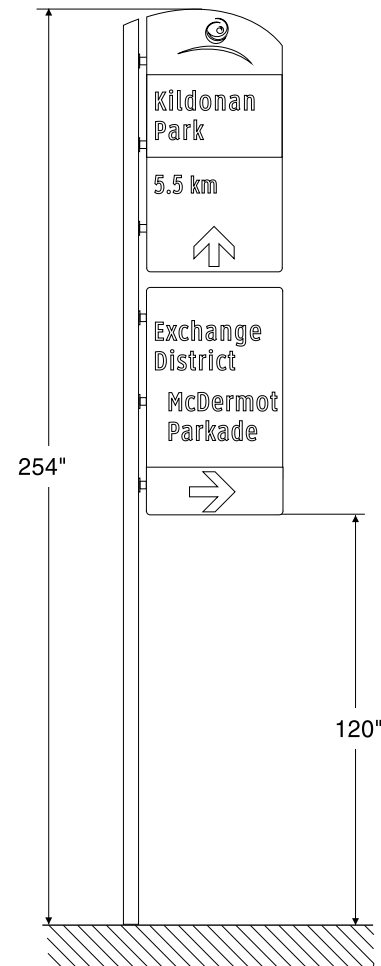





**Field Notes for Installation:**

Before overhead sign pole, just around bend.

Pole Site Location E/S Main St north of William Av

Sign Panel	Panel Type
<b>MN9</b>	<b>A logo</b>

Pole Type **A**

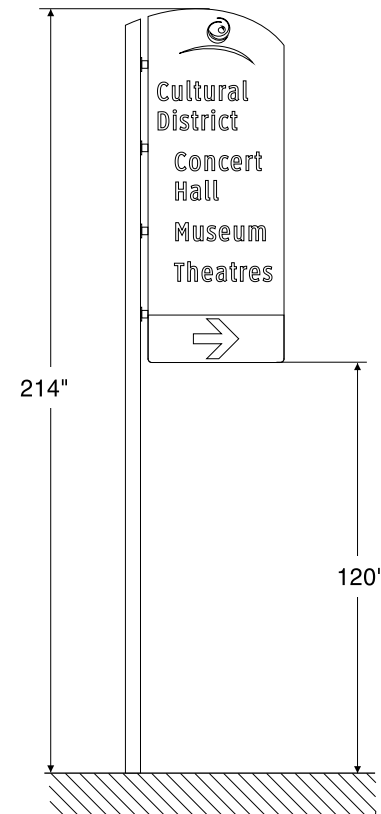



**Field Notes for Installation:**

2nd parking meter back from MB Theatre Ctr.

Pole Site Location S/S Market Av east of Main St

Sign Panel Panel Type

**MN9-F1** **C "P"**

Pole Type **C**

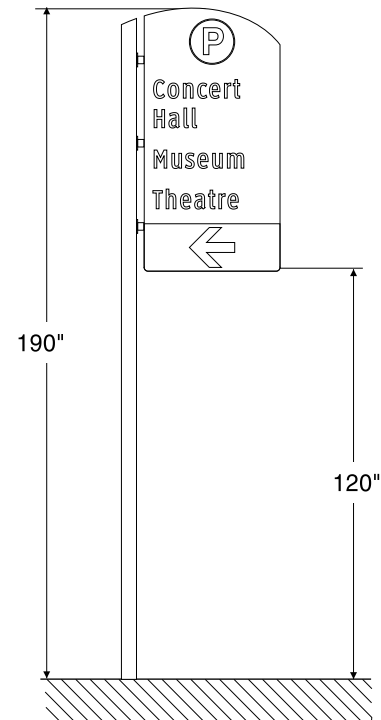



**Field Notes for Installation:**

In front of first tree beyond James. Double-sided on top.

Pole Site Location

E/S Lily St north of James Av (double sided sign)

Sign Panel	Panel Type
<b>MN9-F2-U</b>	<b>D "P"</b>
<b>MN9-F2-L</b>	<b>D lower</b>
<b>MN9-F2-R</b>	<b>D "P" Rs</b>
<b>Pole Type</b>	<b>D+D</b>

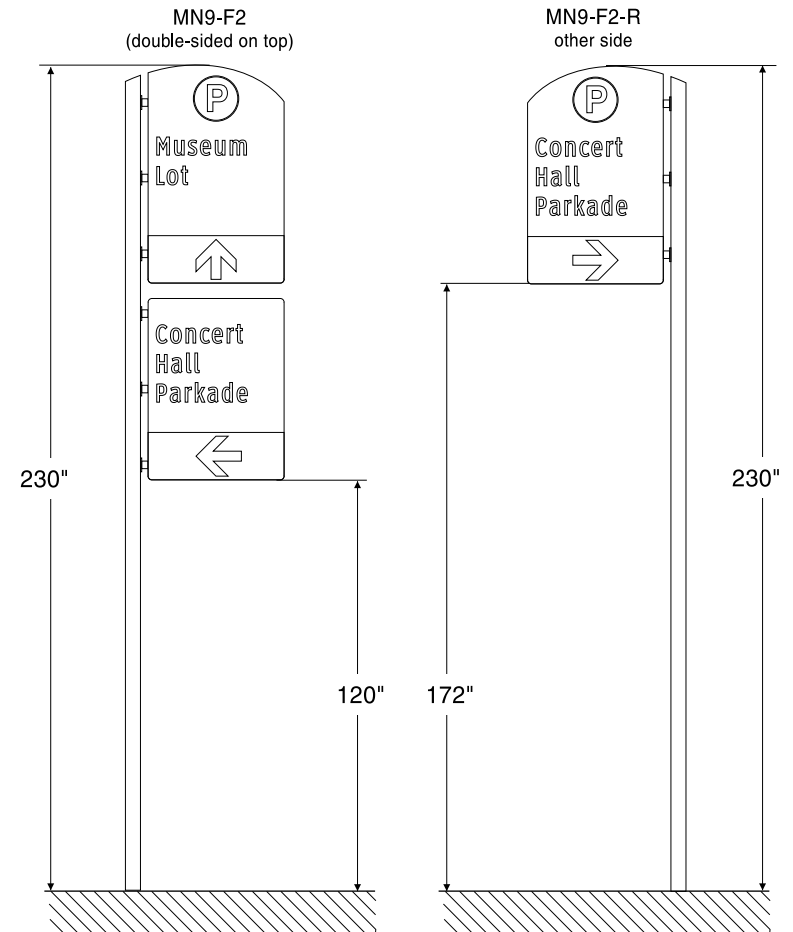



**Field Notes for Installation:**

Just beyond drive-in entrance, check with impark concerning “front section reserved” signs.

Pile Site Location N/S Rupert Av east of Main St (double sided sign)

Sign Panel	Panel Type
<b>MN9-F3</b>	<b>D “P”</b>
<b>MN9-F3-R</b>	<b>D “P” Rs</b>
Pole Type	<b>D</b>

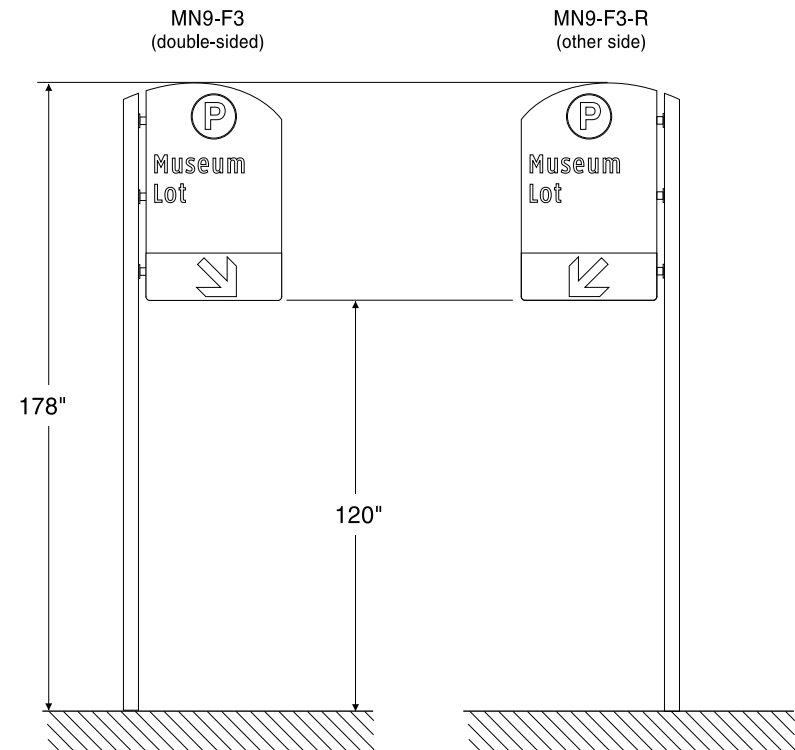

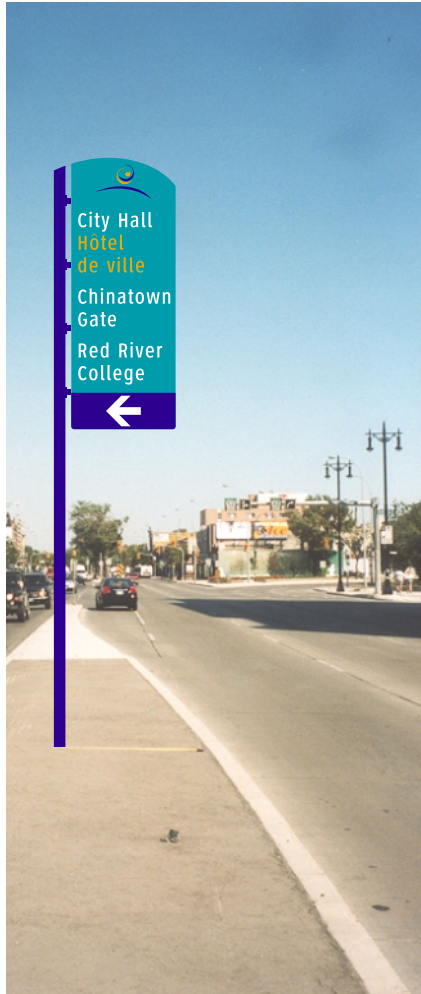

**Field Notes for Installation:**

In median, 50' beyond signal post @ James.

Pile Site Location Median on Main St south of James Av

Sign Panel	Panel Type
------------	------------

<b>MN10</b>	<b>A logo</b>
-------------	---------------

Pole Type	<b>A</b>
-----------	----------

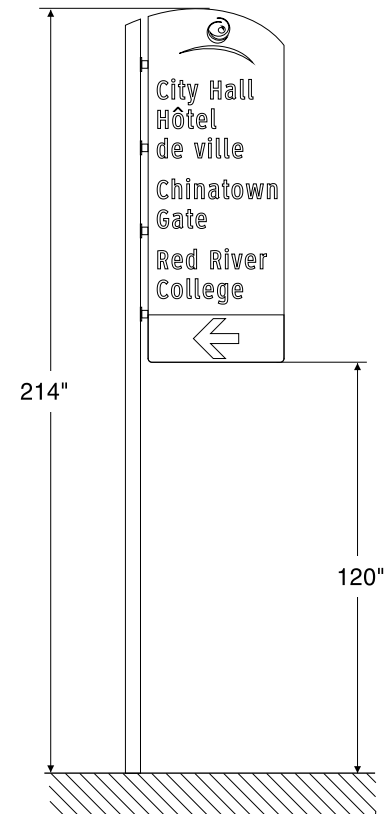



**Field Notes for Installation:**

Between 1st and 2nd meters before Pacific.

Pole Site Location W/S Main St south of Disraeli Frwy

Sign Panel Panel Type

**MS1** **A logo**

Pole Type **A**

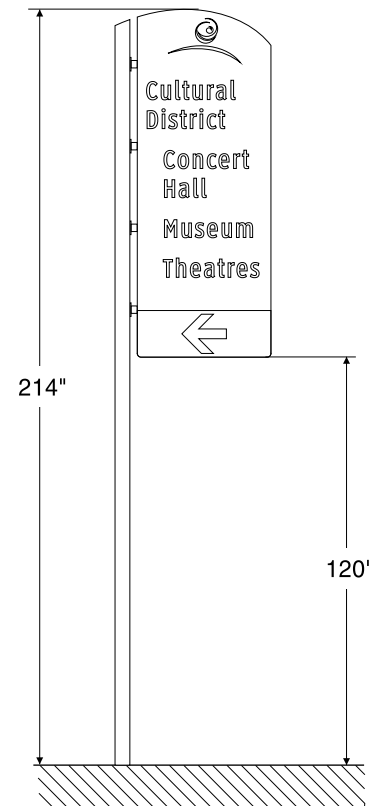



**Field Notes for Installation:**

On side of building at “No Stopping” pole.

Pole Site Location S/S Rupert Av opposite Martha St

Sign Panel Panel Type

**MS1-F** **C “P”**

Pole Type **C**

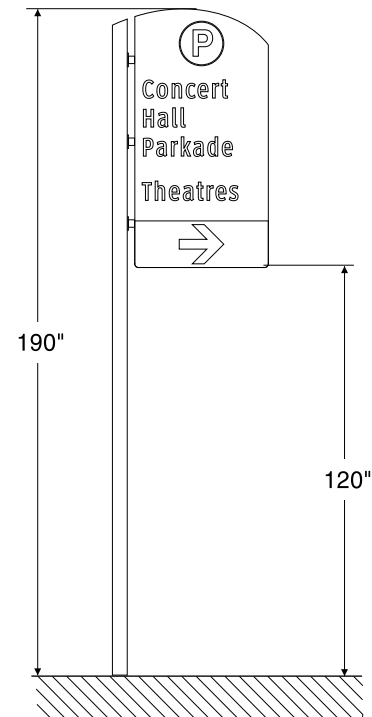



**Field Notes for Installation:**  
25' beyond Pacific corner.

Pole Site Location W/S Main St south of Pacific Av

Sign Panel Panel Type

**MS2** **A logo**

Pole Type **A**

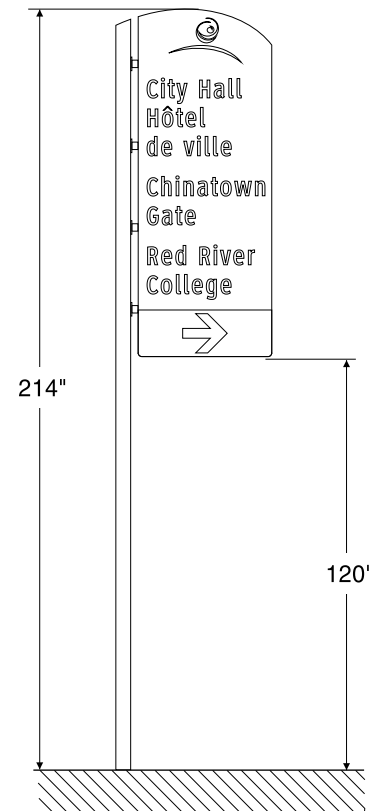





**Field Notes for Installation:**

At 2nd parking meter back from alley.

Pole Site Location N/S Rupert Av east of Princess St

Sign Panel	Panel Type
<b>MS2-F1</b>	<b>B "P"</b>

Pole Type **B**

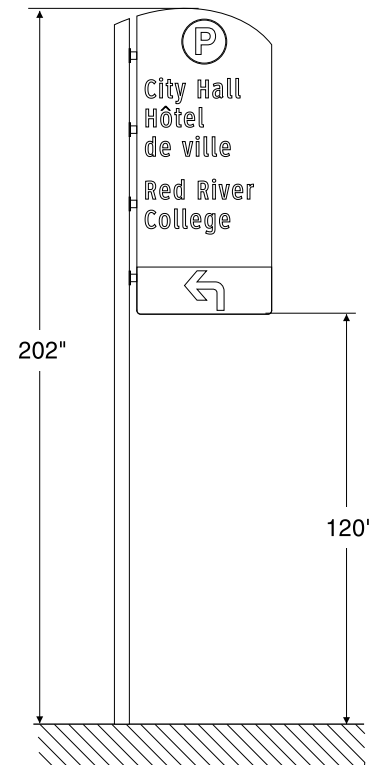

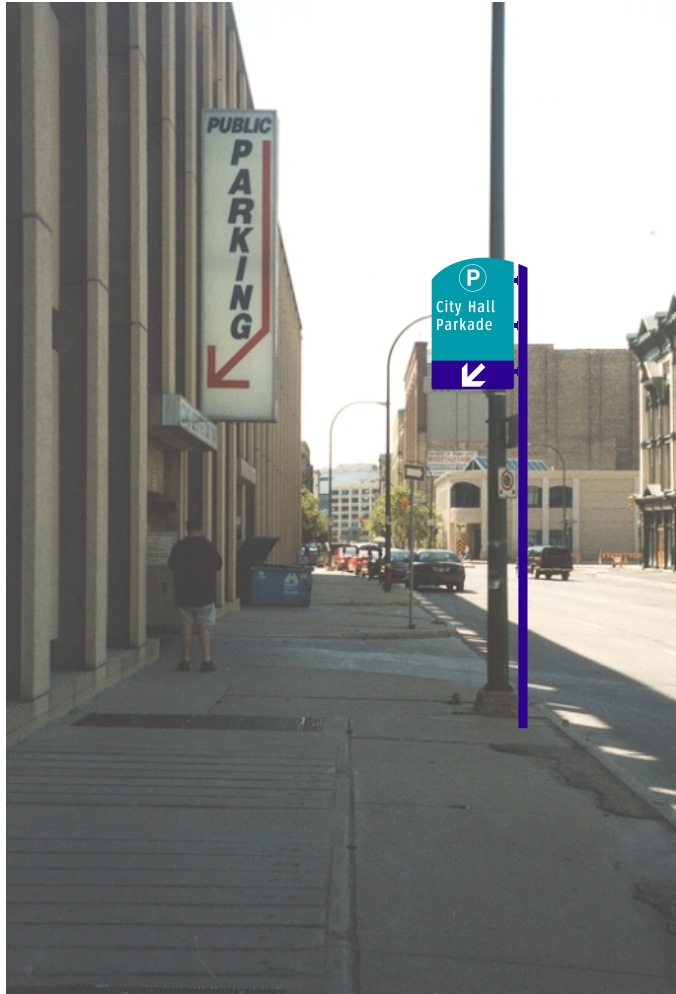

Pole Site Location E/S Princess St opposite Elgin Av

Sign Panel Panel Type

**MS2-F2** **D "P" R**

Pole Type **D**

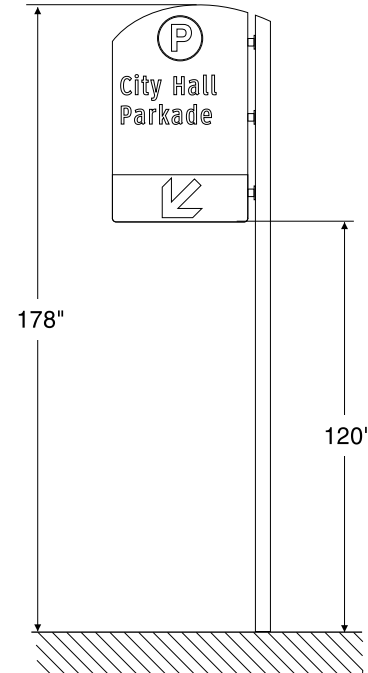

**Field Notes for Installation:**

In front of light pole before driveway entrance.



**Field Notes for Installation:**

Just before concrete abutment before intersection.

Pile Site Location W/S Main St north of Portage Av

Sign Panel	Panel Type
<b>MS3-U</b>	<b>D "P"</b>
<b>MS3-L</b>	<b>D lower</b>
Pole Type	<b>D+D</b>

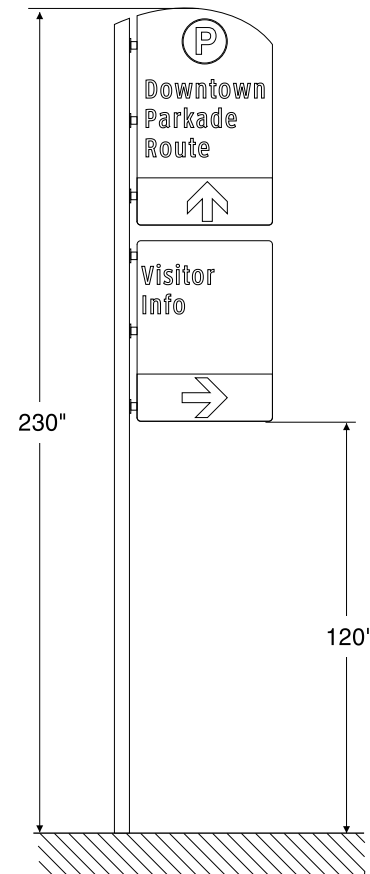

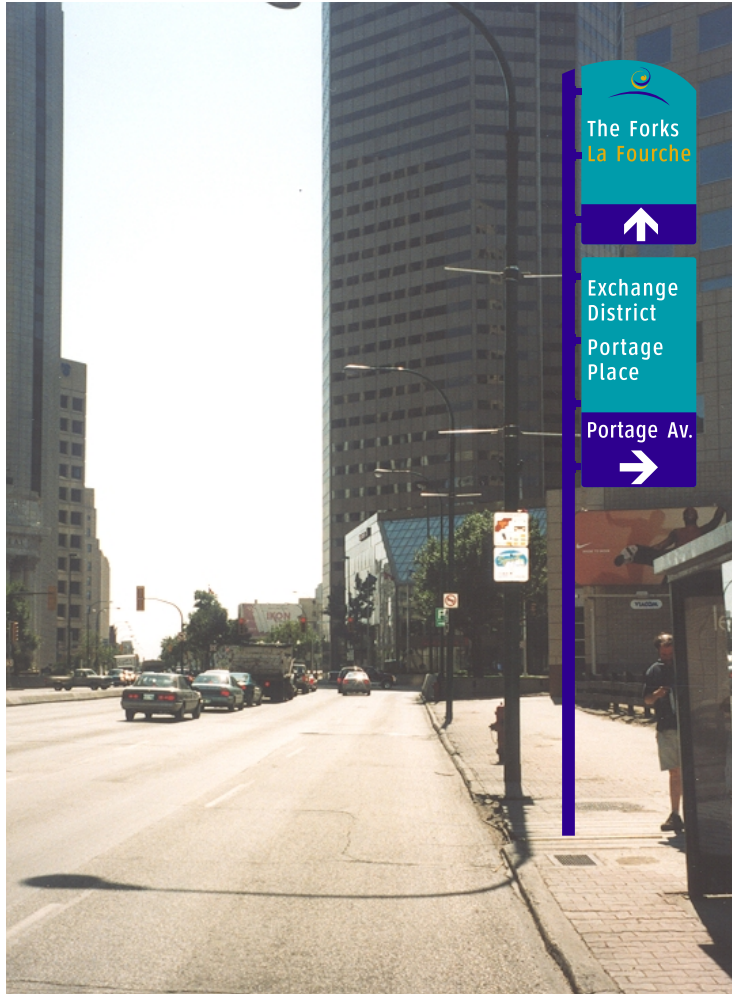

**Field Notes for Installation:**  
Just beyond bus shelter.

Pole Site Location W/S Main St opposite Lombard Av

Sign Panel	Panel Type
<b>MS4-U</b>	<b>D logo</b>
<b>MS4-L</b>	<b>B lower</b>
Pole Type	<b>D+B</b>

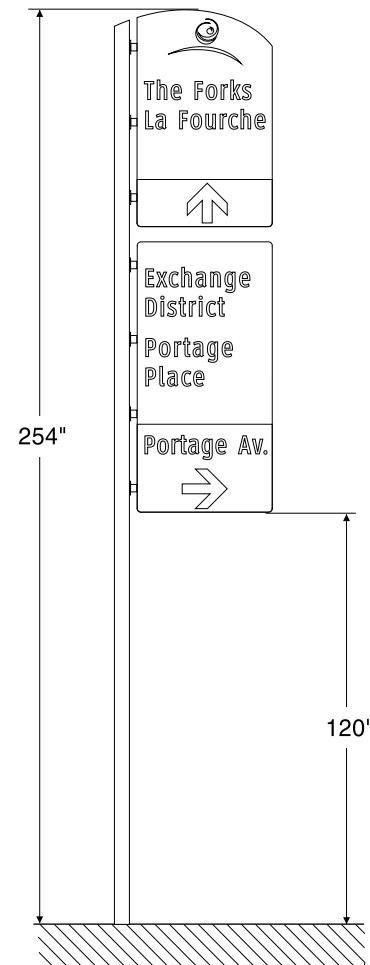



**Field Notes for Installation:**

Just before second light pole after McDermont.

Pole Site Location W/S Main St south of McDermot Av

Sign Panel	Panel Type
<b>MS5-U</b>	<b>D logo</b>
<b>MS5-L</b>	<b>C lower</b>
Pole Type	<b>D+C</b>

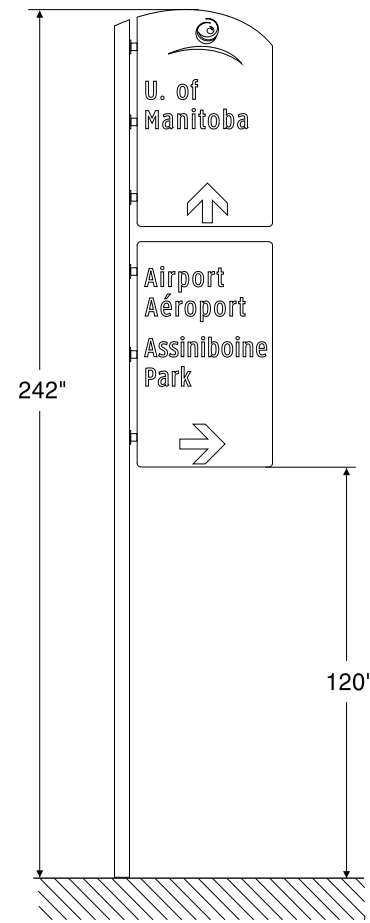



**Field Notes for Installation:**

10' in front of light pole just beyond bus shelters.

Pole Site Location W/S Main St opposite Pioneer Av

Sign Panel	Panel Type
<b>MS6-U</b>	<b>C logo</b>
<b>MS6-L</b>	<b>C lower</b>
Pole Type	<b>C+C</b>

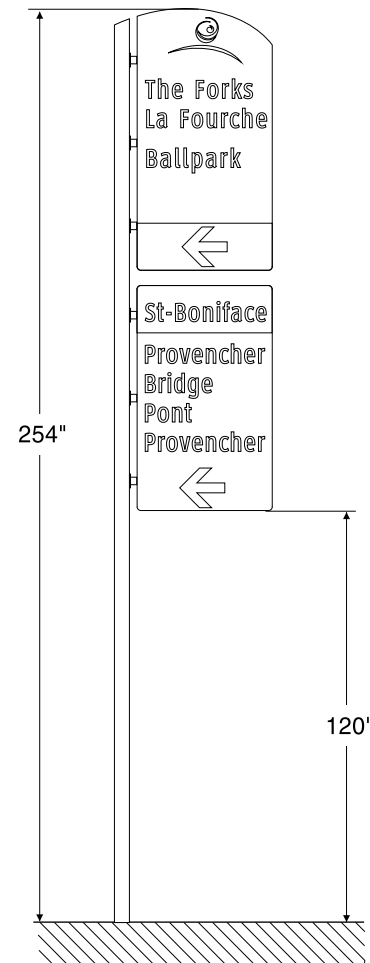

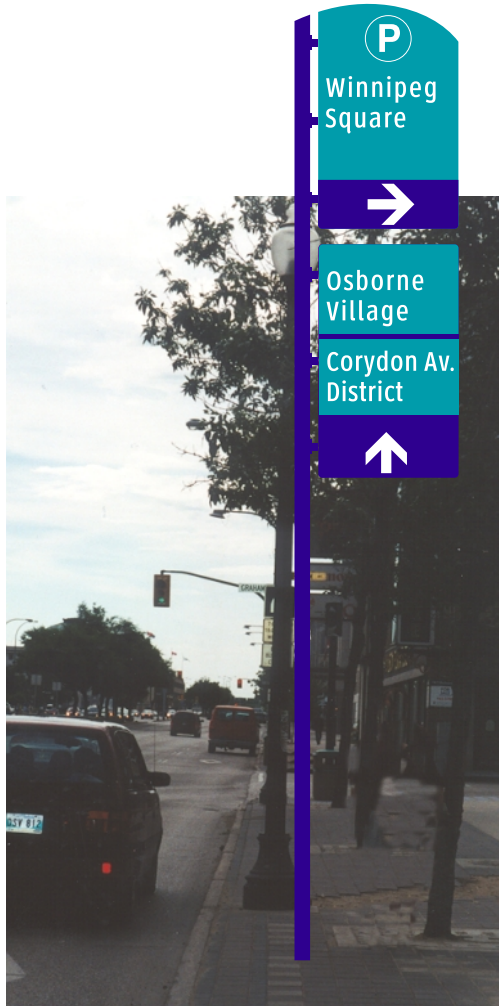

Pole Site Location W/S Main St opposite Water Av

Sign Panel	Panel Type
<b>MS7-U</b>	<b>D "P"</b>
<b>MS7-L</b>	<b>C lower</b>
Pole Type	<b>D+C</b>

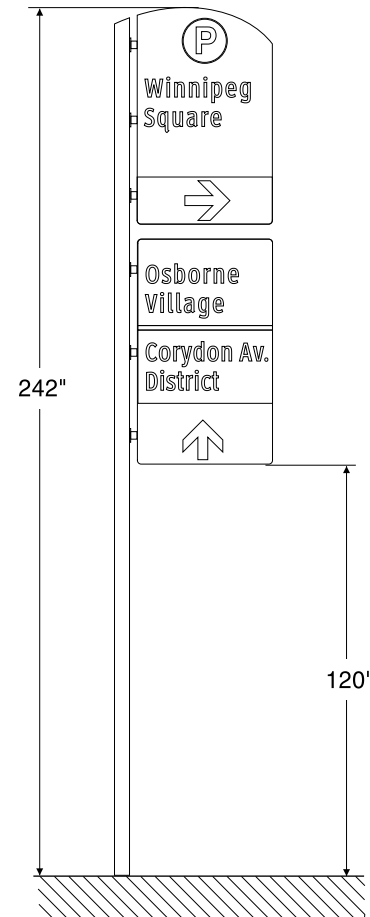

**Field Notes for Installation:**

20' in front of 2nd pole back from Graham, at edge of out-stair from Winnipeg Square.



**Field Notes for Installation:**

Just beyond driveway, before out-drive from Hampton Inn, at "No Stopping."

Pole Site Location W/S Main St north of St Mary Av

Sign Panel	Panel Type
------------	------------

<b>MS8-U</b>	<b>C logo</b>
--------------	---------------

<b>MS8-L</b>	<b>C lower</b>
--------------	----------------

Pole Type	<b>C+C</b>
-----------	------------

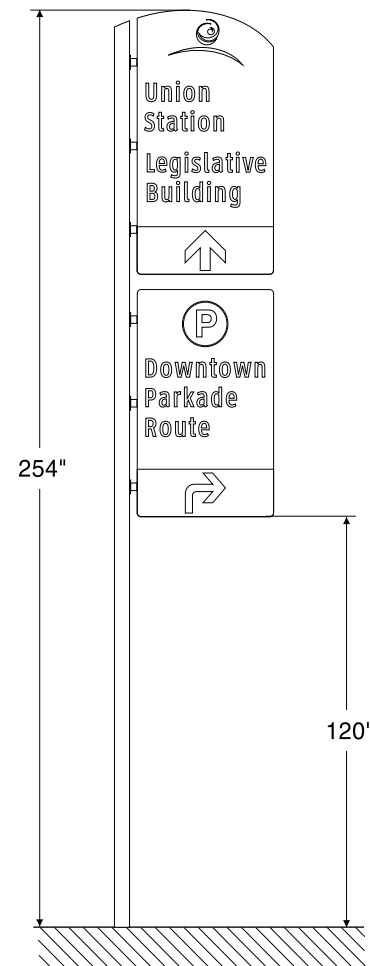





Pole Site Location W/S Main St south of York Av

Sign Panel	Panel Type
<b>MS9</b>	<b>D "P"</b>

Pole Type **D**

**Field Notes for Installation:**

12' beyond overhead arm pole approx. 100' beyond York.

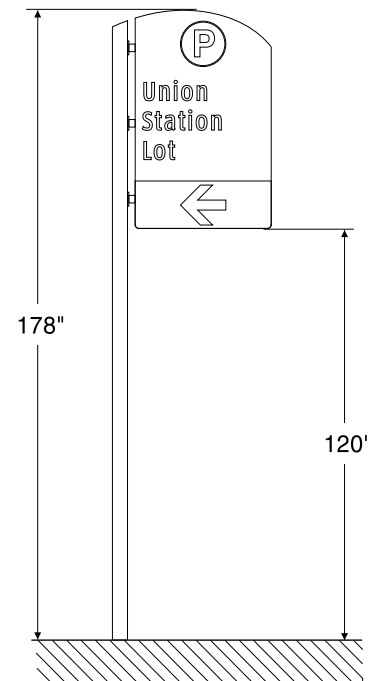

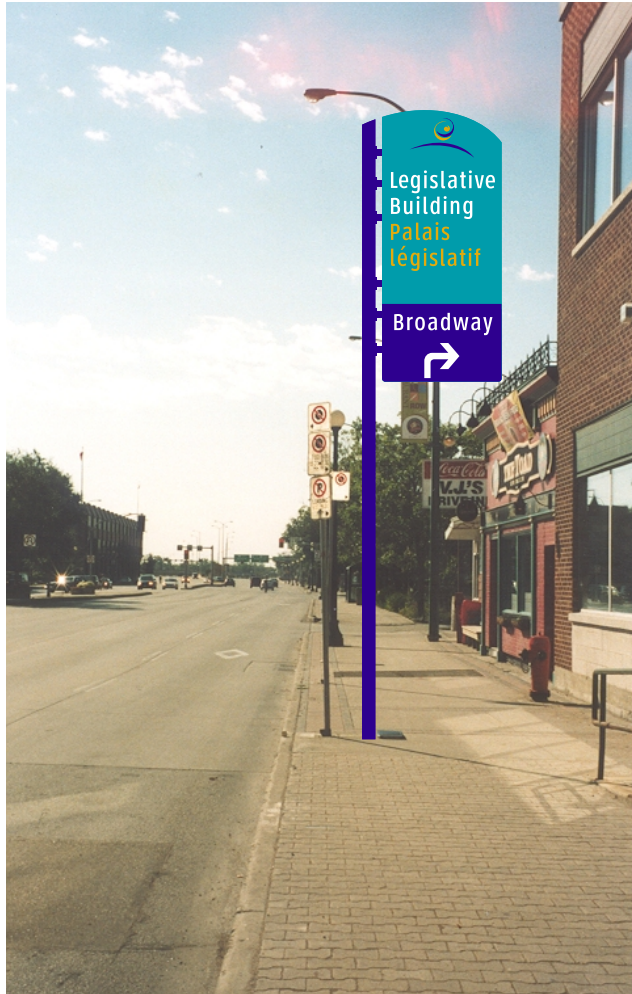

**Field Notes for Installation:**

2nd "No Parking" sign, 80' Back from VJ's Drive.

Pole Site Location W/S Main St north of Broadway

Sign Panel Panel Type

**MS10** **B logo**

Pole Type **B**

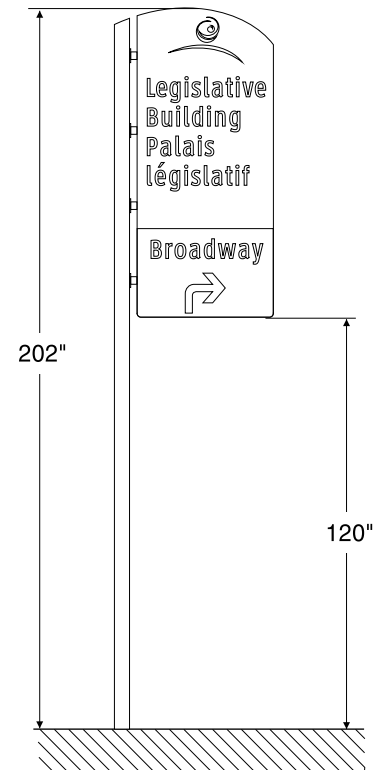

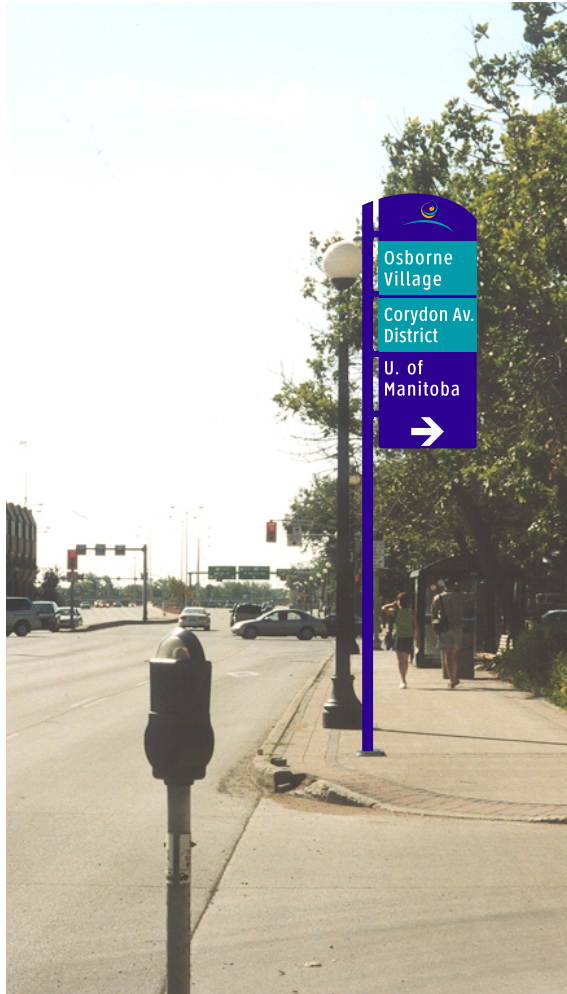

**Field Notes for Installation:**

Just 13' ahead of VJ's Drive-in in brick work.

Pole Site Location W/S Main St north of Broadway

Sign Panel Panel Type

**MS11** **A logo**

Pole Type **A**

