

15 PLAN AT EL. 244.400
WP-M9101 1:150

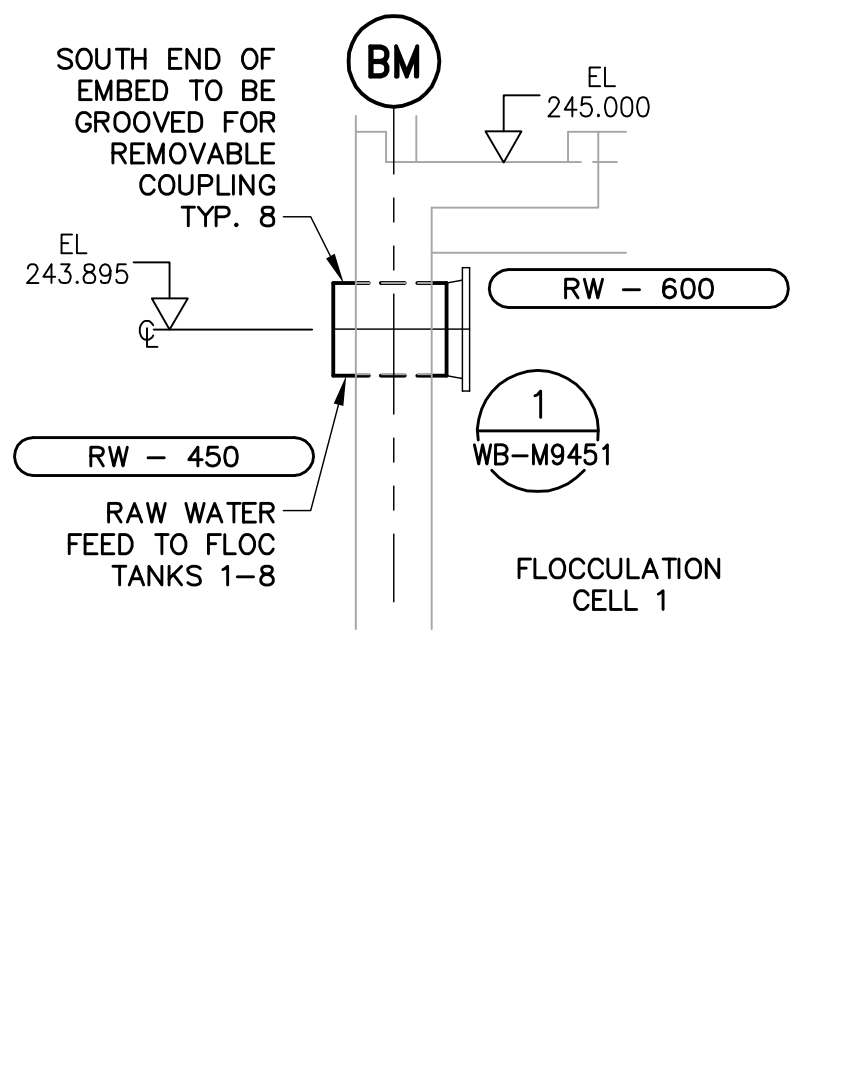

A SECTION - RAW WATER FEEDS TO FLOC TANKS - TYP. 8
WP-M9101 1:50

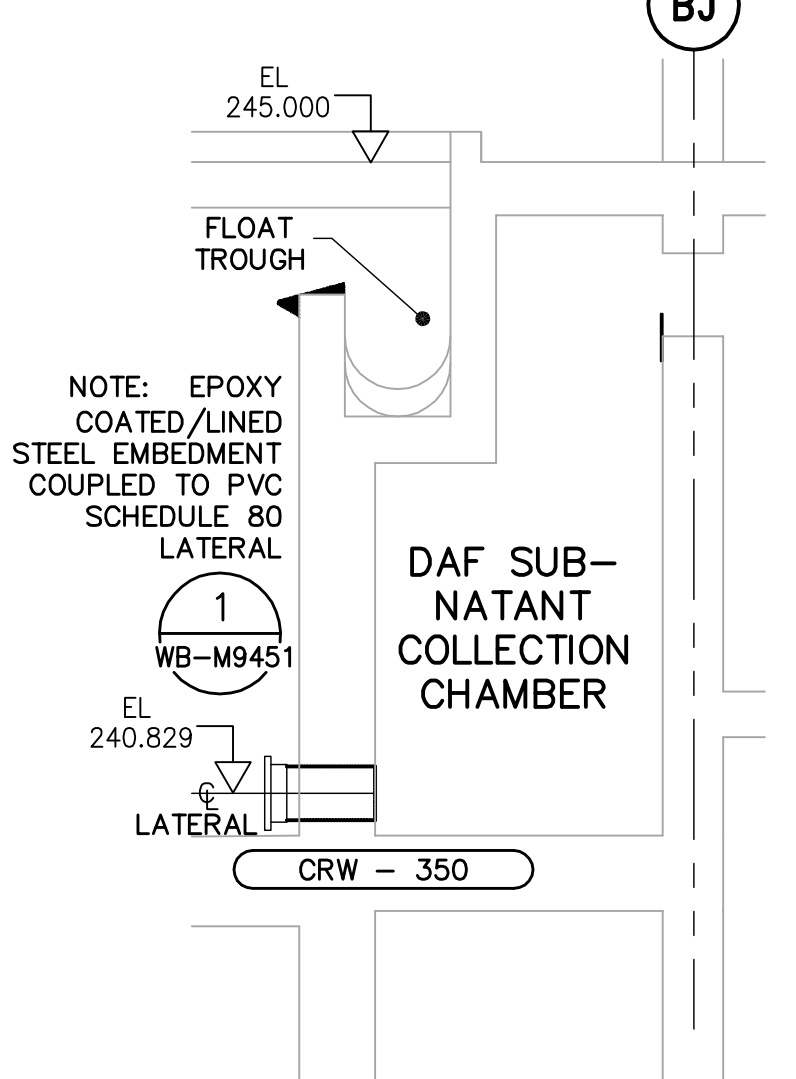

B SECTION - DAF LATERALS - TYP. 64
WP-M9101 1:50

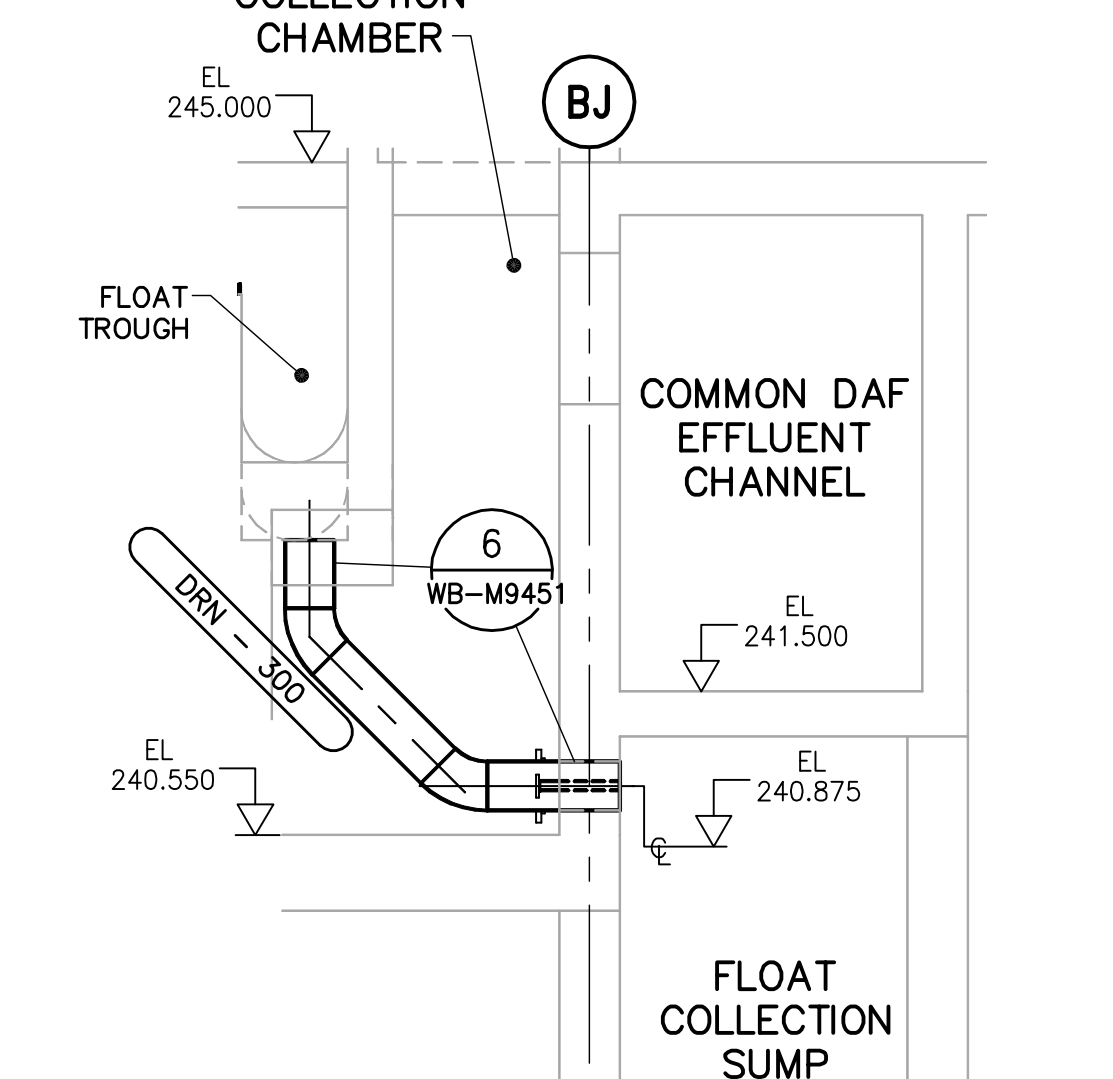

C SECTION - FLOAT TROUGH DRAINS TO FLOAT SUMPS TYP. 8
WP-M9101 1:50

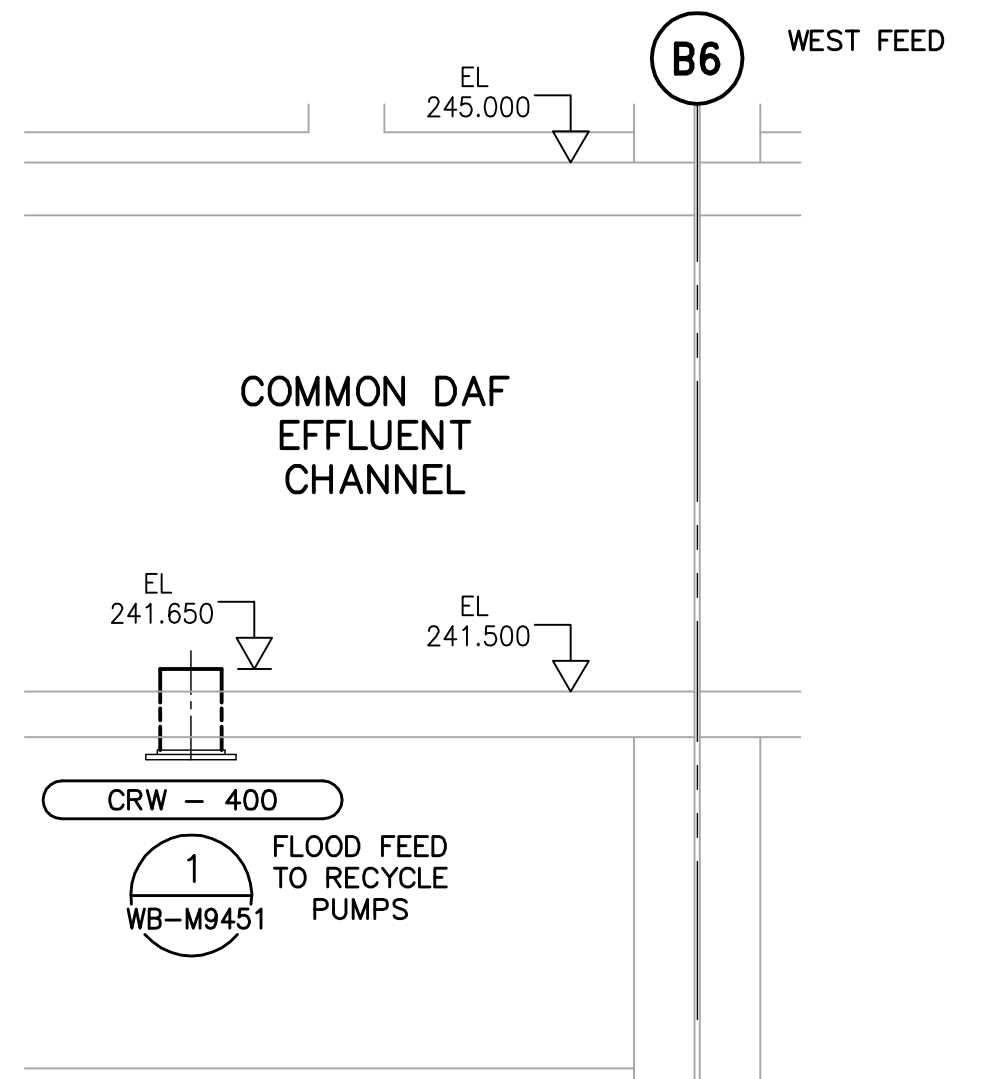

D SECTION - FEEDS TO RECYCLE PUMPS - TYP. 2
WP-M9101 1:50

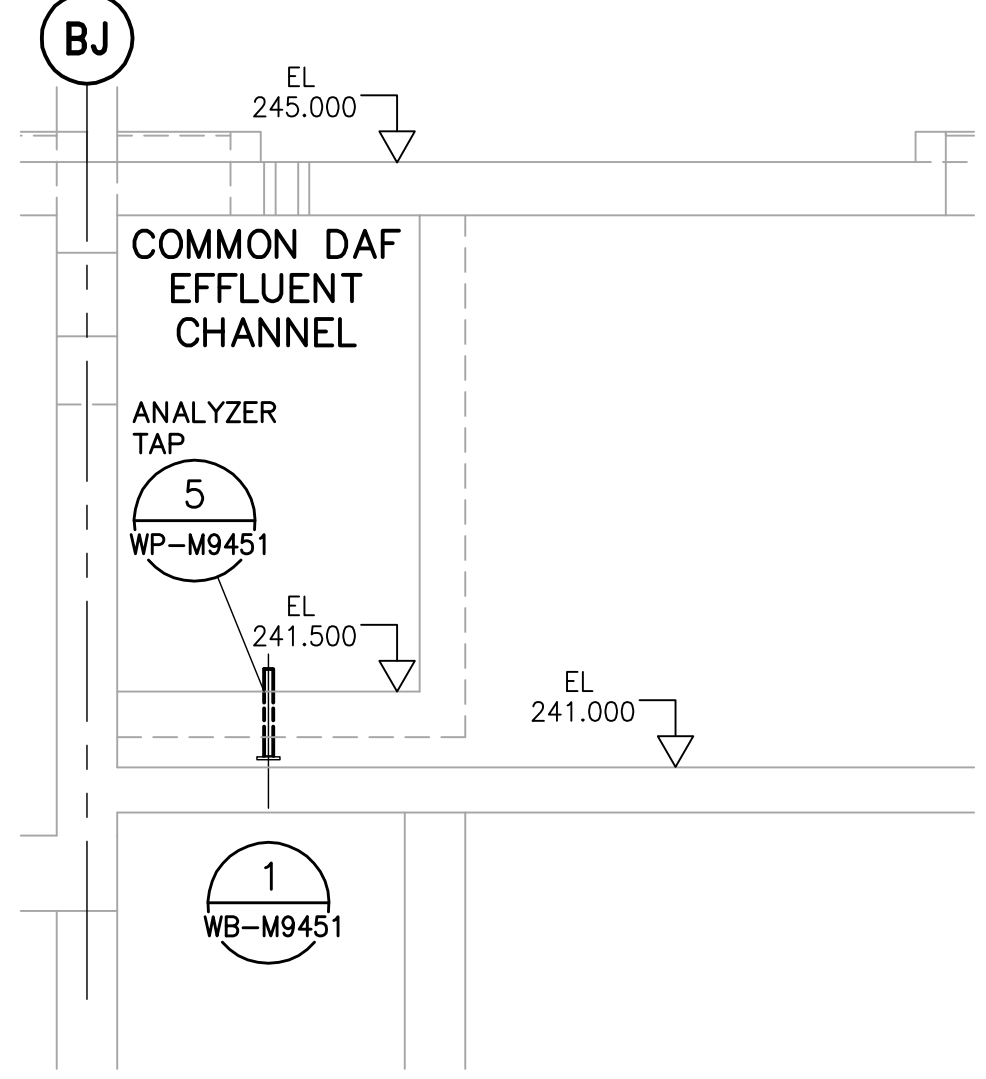

Q SECTION - EMBEDDED ANALYSER TAP TYP. 2
WP-M9101 1:50

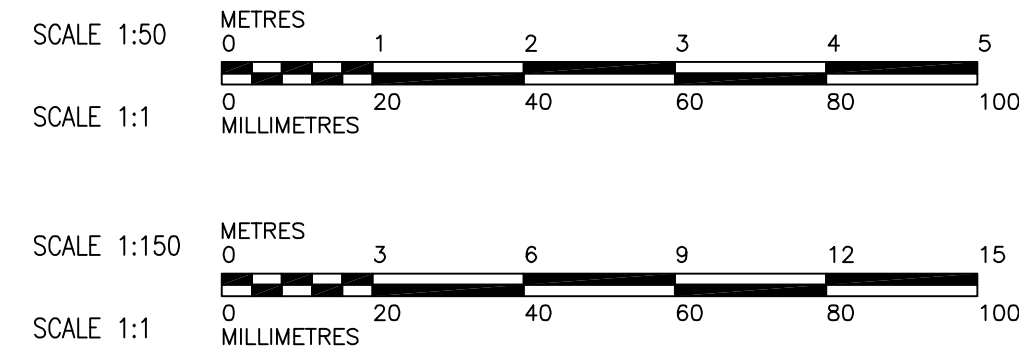
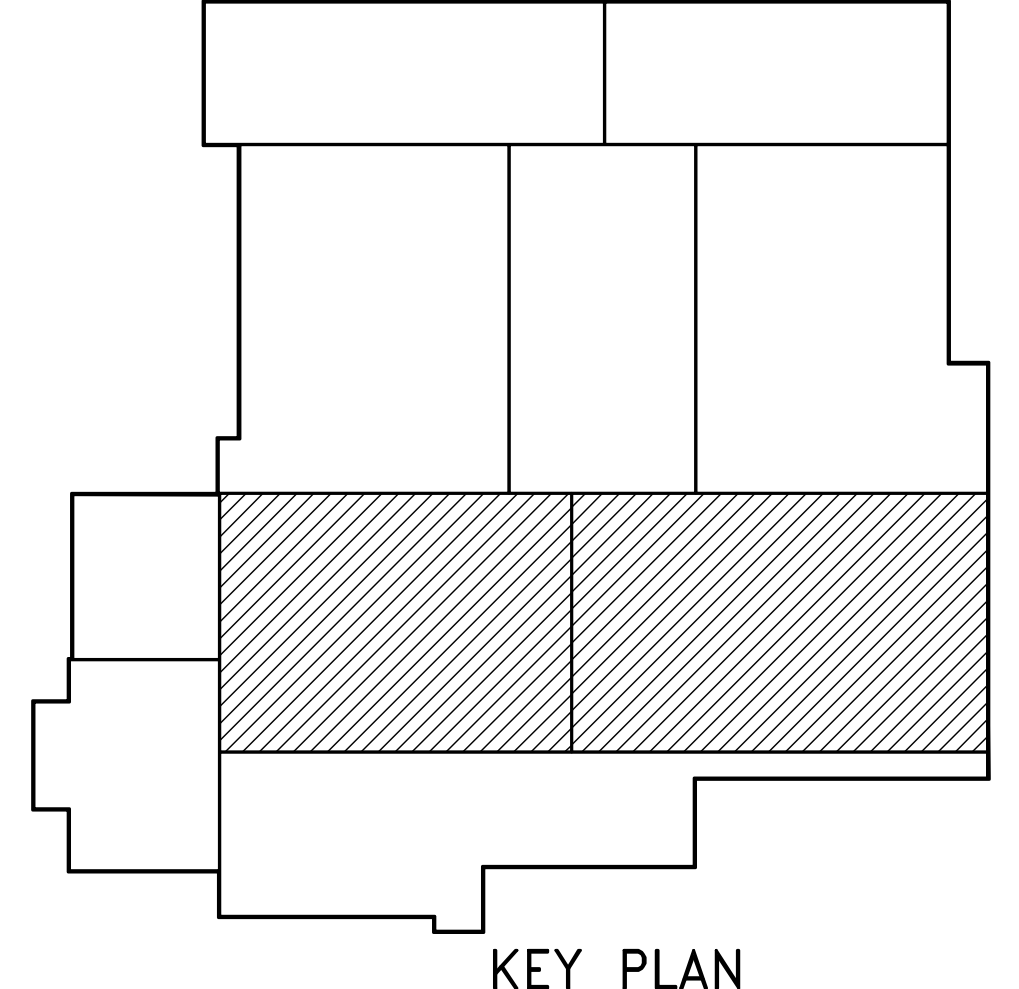

<p>Certificate of Authorization Earth Tech Canada Inc. No. 730 Expiry: April 30, 2006</p>	<p>Frederickson Cooper ARCHITECTS</p>		<p>A Tyco International Ltd. Company</p>		<p>ENGINEER'S SEAL</p> <p>ORIGINAL SIGNED BY S.R. BILEVICIUS 2006/02/07</p>		<p>THE CITY OF WINNIPEG WATER AND WASTE DEPARTMENT ENGINEERING DIVISION</p>	
	DESIGNED BY: KAS	CHECKED BY: SRB	CITY FILE NUMBER		SHEET OF		CITY DRAWING NUMBER	
	DRAWN BY: PL	APPROVED BY: DJT	2006/02/07		WATER TREATMENT PLANT FLOCCULATION AND DAF FOUNDATIONS AND CONCRETE STRUCTURES		1-0601P-A-M9101-001-000	
	SCALE: AS SHOWN	RELEASED FOR CONSTRUCTION BY: R. SOROKOWSKI	CONSULTANT DRAWING NO. WP-M9101		PIPE EMBEDS PLAN @ EL. 244.400 AND SECTIONS FLOCCULATION AND DAF TANKS			
NO. REVISIONS	DATE	BY	DATE	DATE	DATE			