

PIER PLAN
1:50

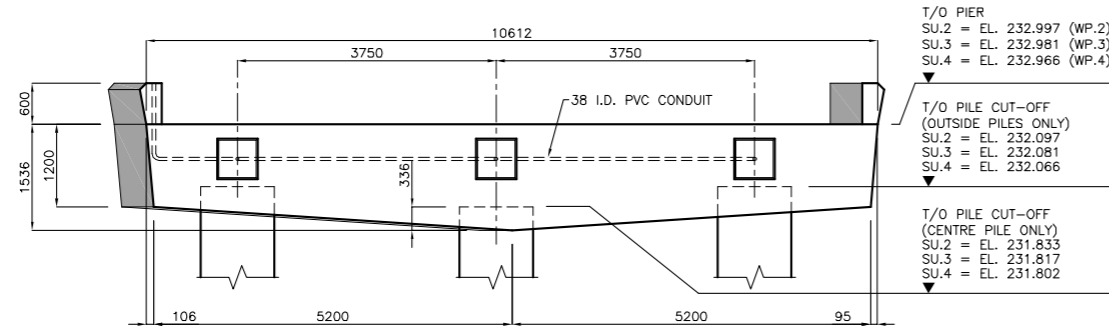

PIER SECTION A
1:50

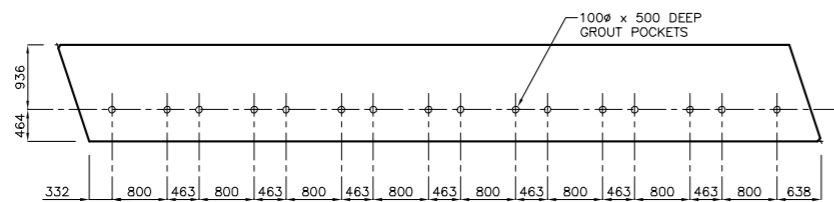

GROUT POCKET LOCATION DETAIL
1:50

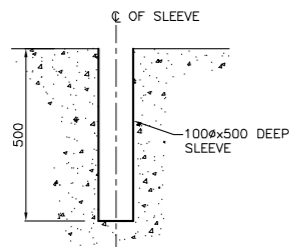

GROUT POCKET DETAIL
1:10

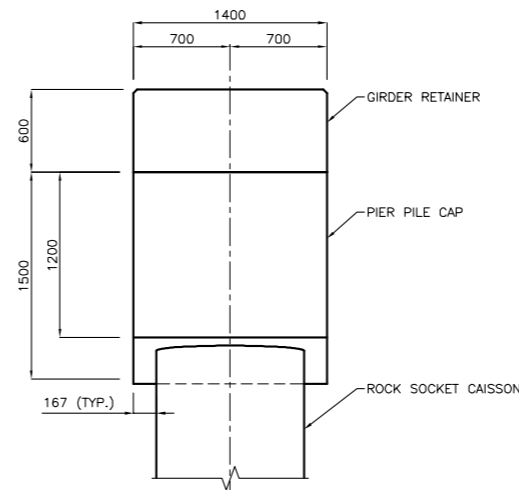

PIER SECTION B
1:25

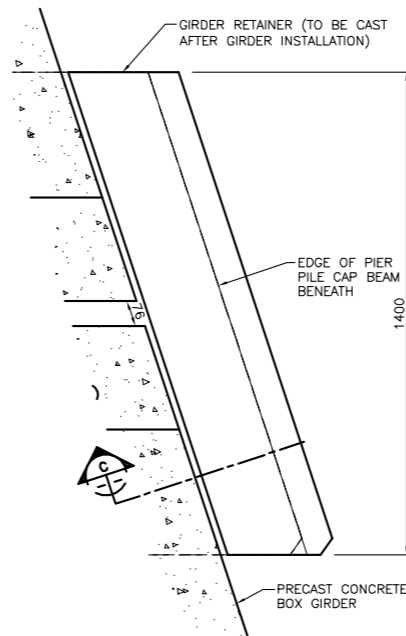

GIRDER RETAINER DETAIL
1:10

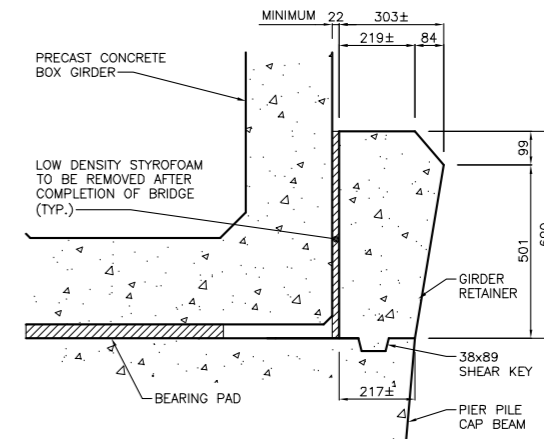

GIRDER RETAINER SECTION C
1:16

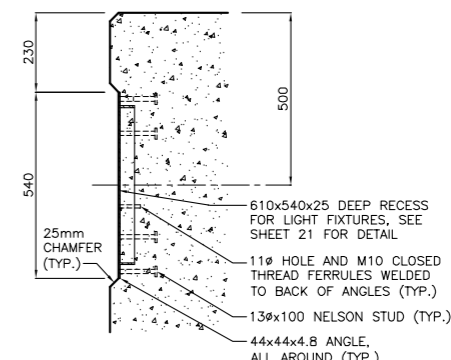

LIGHT FIXTURE RECESS DETAIL
1:25

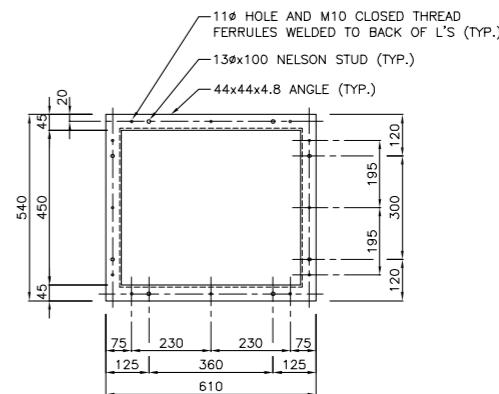

LIGHT FIXTURE ANCHOR DETAIL
1:10

METRIC
WHOLE NUMBERS INDICATE MILLIMETRES
DECIMALIZED NUMBERS INDICATE METRES

APECM
Certificate of Authorization
Stantec Consulting Ltd.
No. 1301 Expiry: April 30, 2006

LOCATION APPROVED UNDERGROUND STRUCTURES		B.M. ELEV.	
SUPV. U/G STRUCTURES COMMITTEE	DATE		
NOTE: LOCATION OF UNDERGROUND STRUCTURES AS SHOWN ARE BASED ON THE BEST INFORMATION AVAILABLE BUT NO GUARANTEE IS GIVEN THAT ALL EXISTING UTILITIES ARE SHOWN OR THAT THE GIVEN LOCATIONS ARE EXACT. CONFIRMATION OF EXISTENCE AND EXACT LOCATION OF ALL SERVICES MUST BE OBTAINED FROM THE INDIVIDUAL UTILITIES BEFORE PROCEEDING WITH CONSTRUCTION.			
1	ISSUED FOR ADDENDUM No.2	05.11.15	MJB
0	ISSUED FOR TENDER	05.10.26	MJB
NO.	REVISIONS	DATE	BY

Stantec Consulting Ltd.	
905 Waverley Street, Winnipeg, Manitoba Tel 204-489-5900 Fax 204-453-9012	
DESIGNED BY: KSA/MJB	CHECKED BY: GWM
DRAWN BY: JMB	APPROVED BY: MJB
AUTHORIZED BY: R. FINGAS, P. ENG. 05.10.26	
BRIDGE PROJECTS ENGINEER	

ENGINEER'S SEAL	
ORIGINAL SEALED BY M.J. BOISSONNEAULT P. ENG. 05.10.26	
CONSULTANT DRAWING NO. 113703042-S10	

THE CITY OF WINNIPEG PUBLIC WORKS DEPARTMENT ENGINEERING DIVISION	
KENASTON UNDERPASS KENASTON BLVD. / CN RIVERS SUB. MILE 5.18 RAILWAY BRIDGE CONSTRUCTION	
PIER CONCRETE DETAILS SU.2, SU.3, & SU.4	
SHEET 12 OF 21	CAD FILE DRAWING NUMBER KU-12-664.dwg
CITY DRAWING NUMBER P-3258-136	