

ALLEY PAVEMENT PROFILE

SCALE: 1:250 HOR
1:10 VER

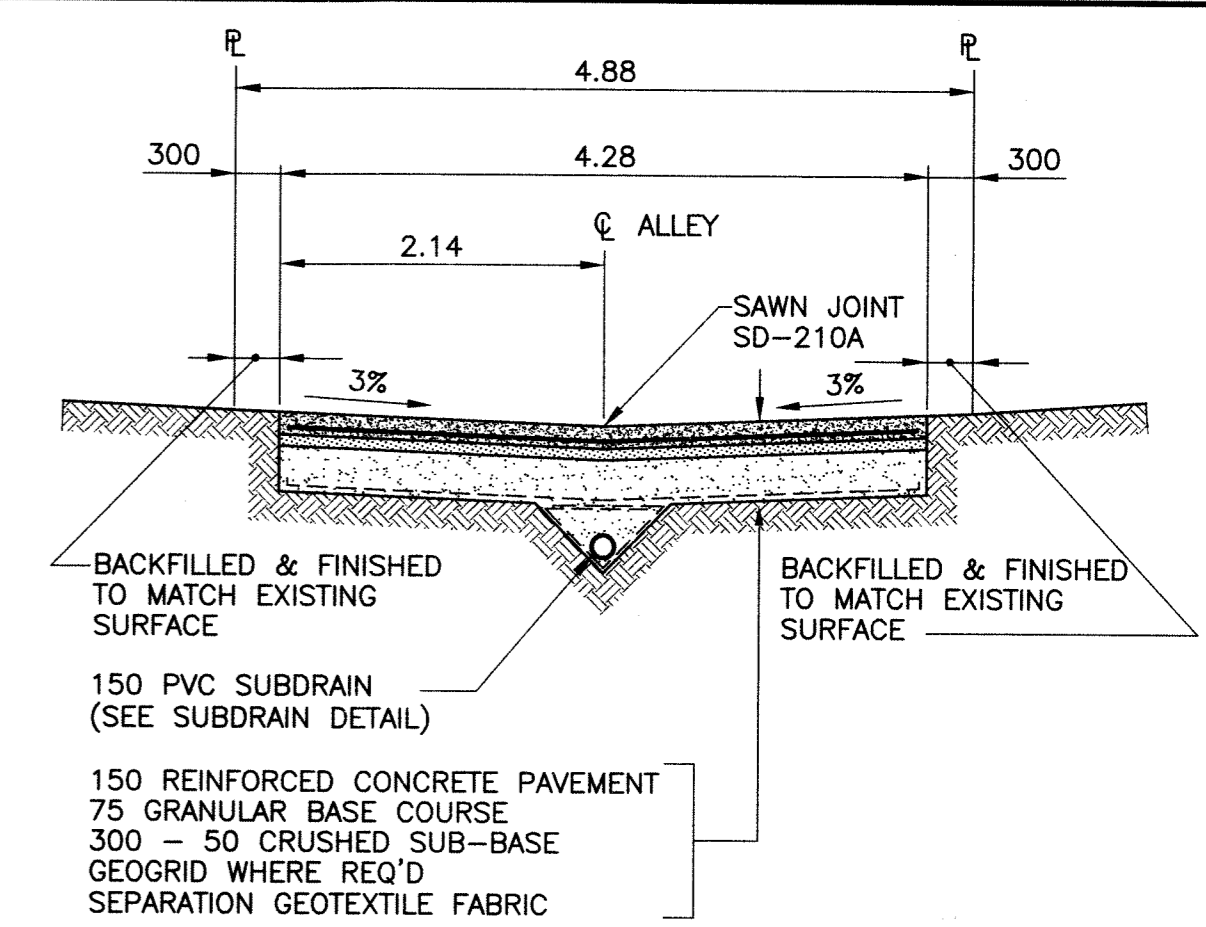

TYPICAL CROSS SECTION

SCALE: 1:50

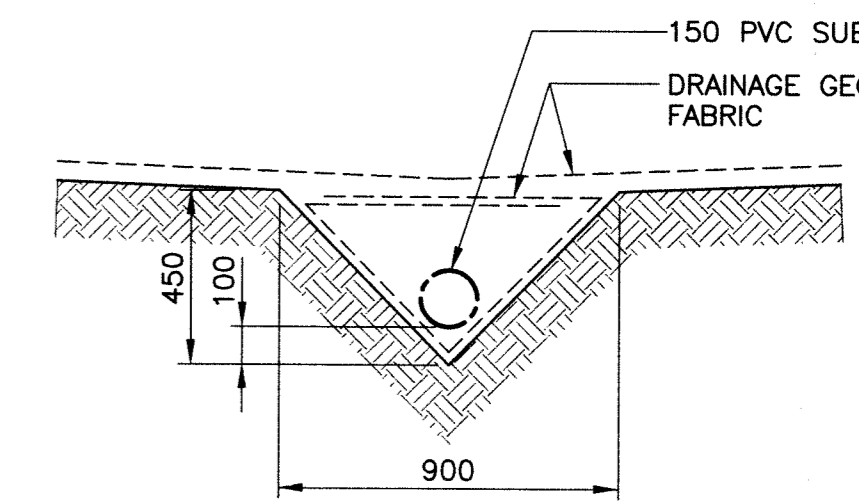

SUBDRAIN DETAIL

SCALE: 1:20

NOTE:

1. STATION CHAINAGE IS BASED ON CENTERLINE OF ALLEY RIGHT OF WAY.
2. ADJUST MH AND CB RIMS TO NEW GRADES.
3. PLUG SUBDRAINS AT TERMINAL ENDS.
4. REGRADE EXISTING PRIVATE SIDEWALKS AS REQUIRED.
5. INSTALLATION OF LIP CURBS AND THEIR EXTENTS TO BE DETERMINED BY THE CONTRACT ADMINISTRATOR.
6. LIGHT STANDARDS, HYDRO POLES AND ANCHORS MAY REQUIRE TEMPORARY SUPPORT/REMOVAL OR REPLACEMENT AT THE CONTRACTOR'S EXPENSE.
7. ISOLATE ALL POLES, BASES AND PILES WITHIN ALLEY RIGHT OF WAY (SD-228C).
8. AVOID DAMAGE TO EXISTING TREES WITHIN THE LIMITS OF CONSTRUCTION.

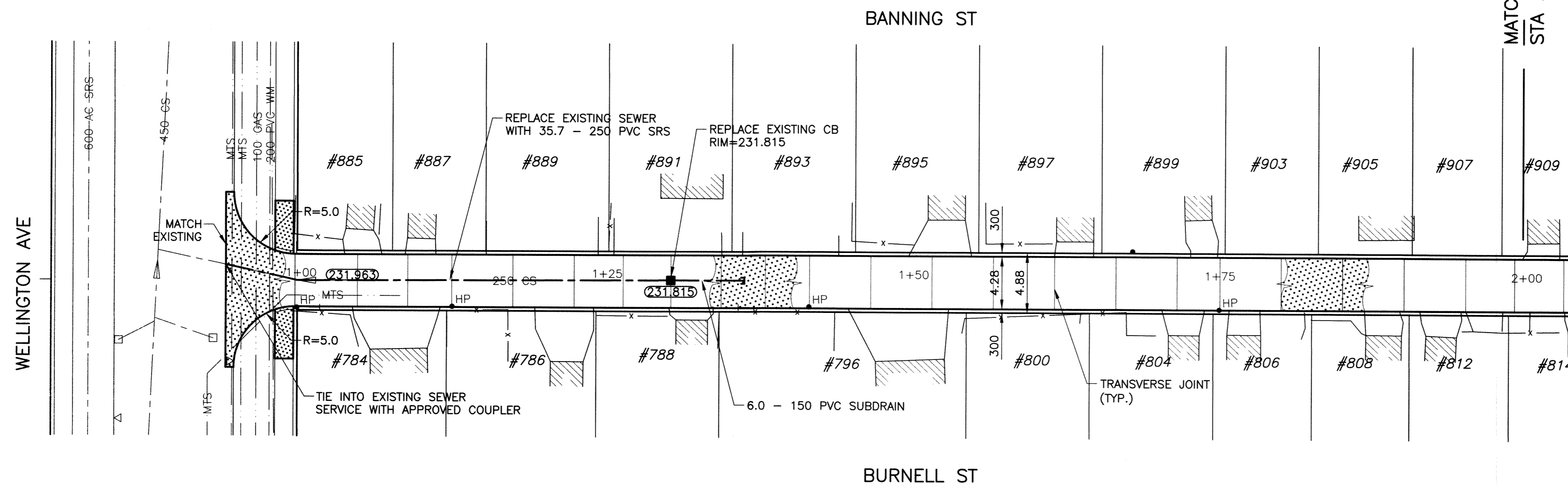

ALLEY PAVEMENT PLAN

SCALE: 1:250 HOR

PROPERTY LIMITS DELINEATION

DELINEATION OF PROPERTY LIMITS AS SHOWN ON THIS DWG DOES NOT REPRESENT A "LEGAL SURVEY". KGS GROUP MAKES NO REPRESENTATION OR WARRANTY AS TO THE ACCURACY OF PROPERTY LIMITS DELINEATED ON THIS DWG, NOR ON THE DIMENSIONAL ACCURACY OF DWG FEATURES RELATIVE TO THOSE PROPERTY LIMITS.

WARNING

1. NOTIFY THE GAS COMPANY OF THE PROPOSED LOCATION OF EXCAVATION.
2. TAKE PRECAUTION TO AVOID DAMAGE TO GAS COMPANY INSTALLATIONS.
3. SEE PROVINCIAL REGULATION 210/72 FOR DETAILS.

METRIC

WHOLE NUMBERS INDICATE MILLIMETRES
DECIMALIZED NUMBERS INDICATE METRES

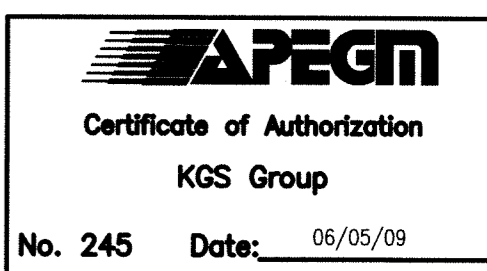
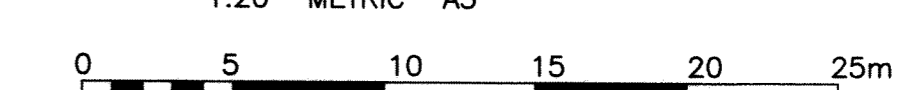
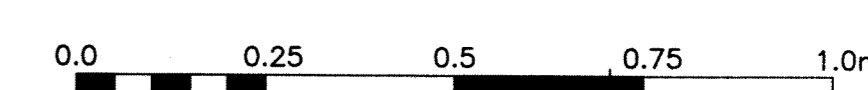
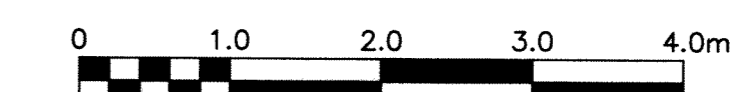

P:\Projects\2009\09-0107-03.Doc Control\Issued\Source\Drawings\09-0107-03_00014-00014-Rev 0.dwg - Tab: 14 Plotted By: DBoerche 06/05/2009 [Tue 2:33pm]

300 LBS	LAND DRAINAGE SEWER	300 LBS	CONCRETE JOINT				
250 WWS	WASTE WATER SEWER	250 WWS	TEST HOLE				
	GAS		GUY WIRE				
	HYDRO		LIGHT STANDARD				
	M.T.S.		BACK OF CURB				
150 WM	WATERMAIN	150 WM	CONCRETE				
	HYDRANT		ASPHALT				
	VALVE		SIDEWALK				
	MANHOLE		PROPERTY LINE				
	CATCH BASIN		SURVEY BAR				
	CURB INLET		GEODETIC BENCHMARK				
	POLES		ELEVATION				
EXISTING	LEGEND-PLAN	PROPOSED	EXISTING	LEGEND-PLAN	PROPOSED	EXISTING	LEGEND-PROFILE

LOCATION APPROVED UNDERGROUND STRUCTURES

SUPV. U/G STRUCTURES DATE COMMITTEE

NOTE:
LOCATION OF UNDERGROUND STRUCTURES AS SHOWN ARE BASED ON THE BEST INFORMATION AVAILABLE. BUT NO GUARANTEE IS GIVEN THAT ALL EXISTING UTILITIES ARE SHOWN OR THAT THE GIVEN LOCATIONS ARE EXACT. CONFIRMATION OF EXISTENCE AND EXACT LOCATION OF ALL SERVICES MUST BE OBTAINED FROM THE INDIVIDUAL UTILITIES BEFORE PROCEEDING WITH CONSTRUCTION.

B.M.	36-014
ELEV.	232.151
NO.	REVISIONS
DATE	BY
06/05/09	JDF
17/11/08	RJH

KGS GROUP CONSULTING ENGINEERS & PROJECT MANAGERS

WINNIPEG (204) 896-1209
THUNDER BAY (807) 345-2233

DESIGNED BY: JDF
CHECKED BY: RJH

DRAWN BY: GEL
APPROVED BY:

HOR. SCALE: 1:250
VERTICAL: 1:50

RELEASED FOR CONSTRUCTION: DATE



THE CITY OF WINNIPEG PUBLIC WORKS DEPARTMENT TRANSPORTATION ENGINEERING DIVISION

PROJECT TITLE: **2009 ALLEY RENEWAL PROGRAM**

BANNING ST./BURNELL ST. ALLEY
WELLINGTON AVE. TO 190m NORTH
STA. 1+00.0 TO STA. 2+00.0

SHEET 14 OF 15

COMPUTER FILE NAME: BANNING-BURNELL-PL0T

CITY DRAWING NUMBER: 0014

CONSULTANT DRAWING NO. 09-0107-03