

A1 SIZE 23.4" x 33.1" (594mm x 841mm)

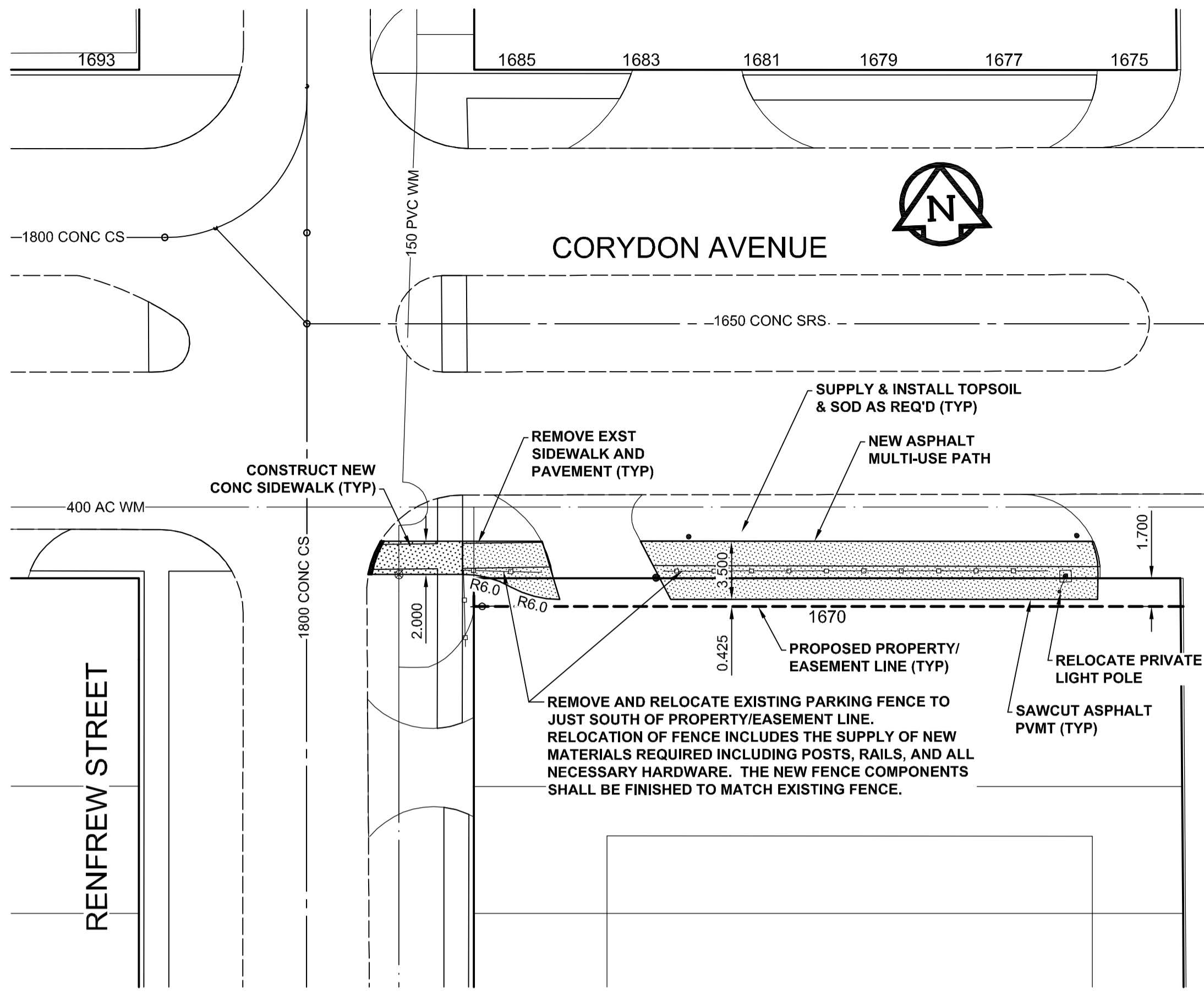

MATCH LINE - DWG NO. 01

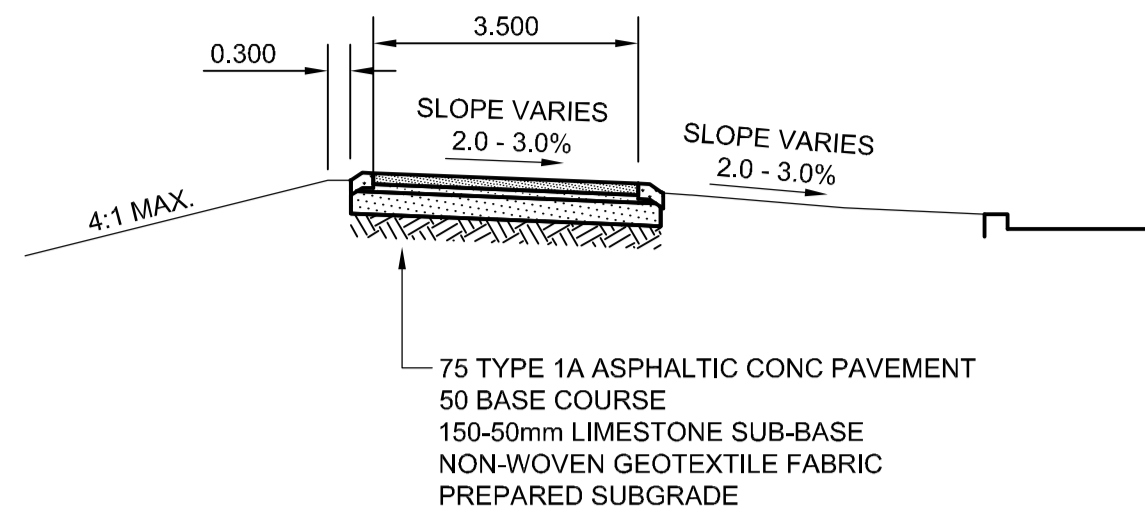

**TYPICAL SECTION**

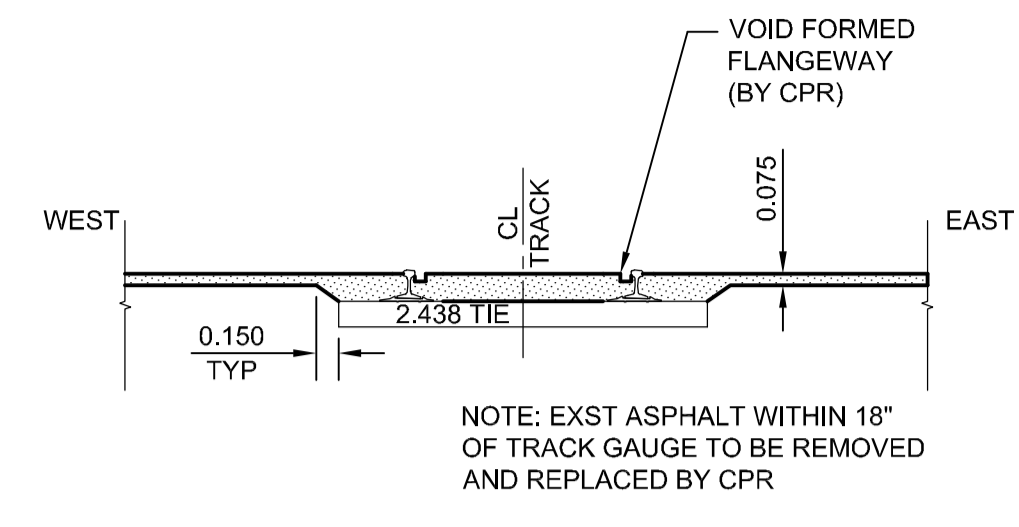
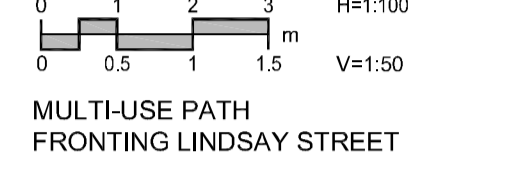

**RAIL CROSSING SECTION**

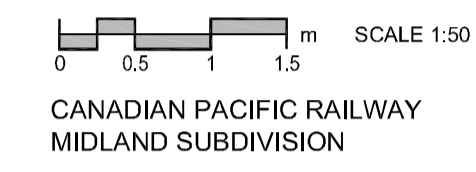

PLOT: 10/06/08 2:58:40 PM

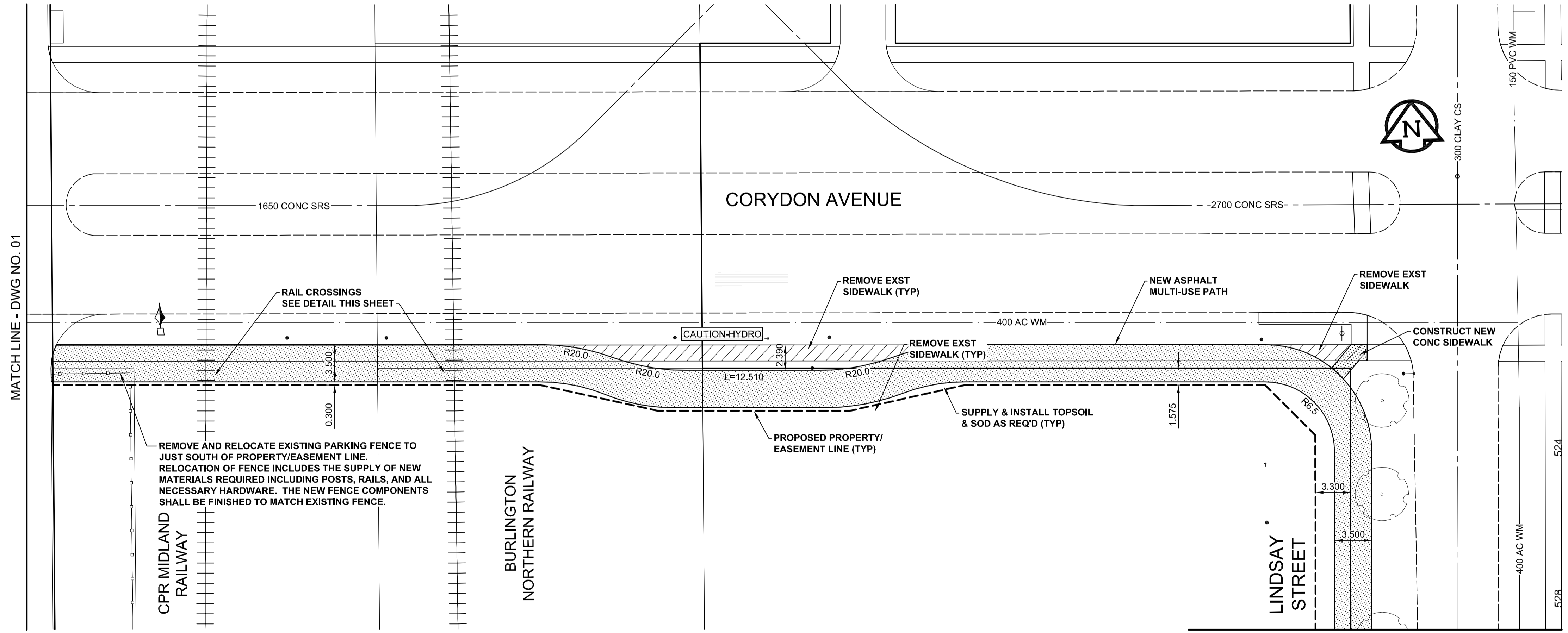

MATCH LINE - DWG NO. 01

MATCH LINE - DWG NO. 02

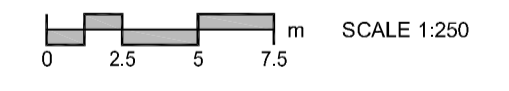

**AECOM**  
Certificate of Authorization  
AECOM Canada Ltd.  
No. 4671 Date: June 8/10  
BID OPPORTUNITY NO. 307-2010

**METRIC**  
WHOLE NUMBERS INDICATE MILLIMETRES  
DECIMALIZED NUMBERS INDICATE METRES

	GAS		MANHOLE
	MTS		CATCH BASIN / CATCH PIT
	HYDRO		CURB INLET WITH BOX
	CATV/FO		TREE
	TRAFFIC SIGNALS/PIT		TEST HOLE
	LAND DRAINAGE SEWER		PROPERTY LINE
	SANITARY/COMBINED SEWER		SURVEY BAR
	SSP/DCP		FENCE
	WATERMAIN		BOC/EOPAVT
	SUBDRAIN		ELEVATION (33.100)
	DITCH		TRAFFIC SIGN
	EXISTING		LEGEND - PLAN
	NEW		LEGEND - PLAN
	EXISTING		LEGEND - PLAN
	NEW		LEGEND - PLAN
	EXISTING		LEGEND - PLAN
	NEW		LEGEND - PLAN

<b>CONCRETE PAVEMENT</b>	
<b>ASPHALT PAVEMENT</b>	
<b>CONC. SIDEWALK/MEDIAN</b>	
<b>PAVING STONE</b>	
<b>GRAVEL</b>	
<b>RAMP CURB</b>	
<b>PLANING/REMOVAL</b>	

**LOCATION APPROVED**  
UNDERGROUND STRUCTURES

BM -  
ELEV -

DATE

NOTE:  
LOCATION OF UNDERGROUND STRUCTURES AS SHOWN ARE BASED ON THE BEST INFORMATION AVAILABLE. BUT NO GUARANTEE IS GIVEN THAT ALL EXISTING UTILITIES ARE SHOWN OR THAT THE GIVEN LOCATIONS ARE EXACT. CONFIRMATION OF EXISTENCE AND EXACT LOCATION OF ALL SERVICES MUST BE OBTAINED FROM THE INDIVIDUAL UTILITIES BEFORE PROCEEDING WITH CONSTRUCTION.

<b>AECOM</b>	DESIGNED BY: JGK/GFN	CHECKED BY: JC
	DRAWN BY: KLC	APPROVED BY: TGS
	HOR. SCALE: 1:250	RELEASED FOR CONSTRUCTION: [Signature]
	VERT. SCALE: 1:10	DATE: June 8, 2010
	DATE: 10/06/09	

PROFESSIONAL'S SEAL  
PROVINCE OF MANITOBA  
REGISTERED PROFESSIONAL ENGINEER  
J.M. CRANG  
June 8/10

**THE CITY OF WINNIPEG**  
PUBLIC WORKS DEPARTMENT  
ENGINEERING DIVISION

2010 ACTIVE TRANSPORTATION/ INFRASTRUCTURE STIMULUS PROGRAM

**FLEET/ WARSAW AVENUE RENFREW STREET TO LINDSAY STREET MULTI-USE PATH**

CITY DRAWING NUMBER: W-377-01  
SHEET 1 OF 22  
DRAWING No. 01 REV 0