

Eastbound Tyndall, N/S Chudley
Stop 30685 Chudley

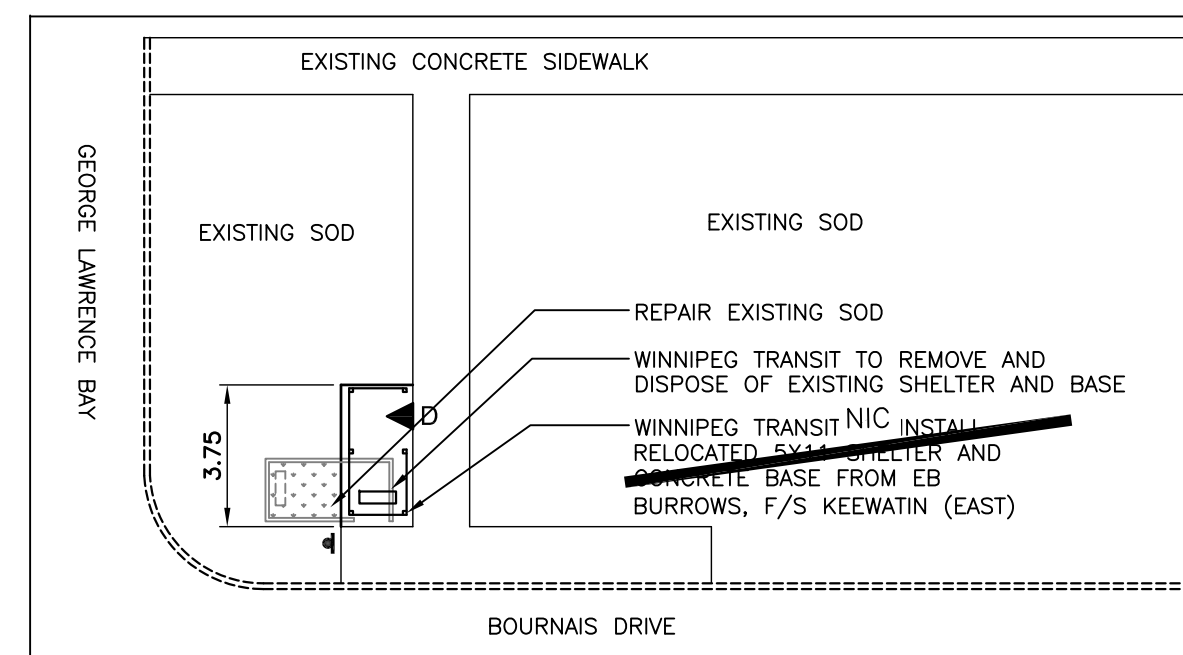

Southbound Bournais, N/S Opp Dzyndra
Stop 40167 Dzyndra

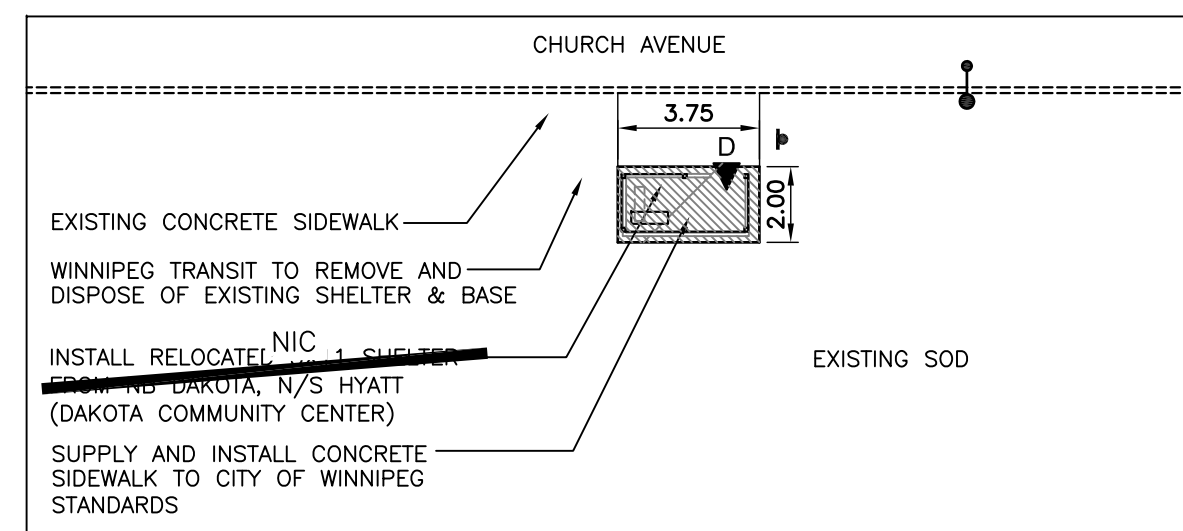

Eastbound Church, N/S Hutchings
Stop 30564 Hutchings

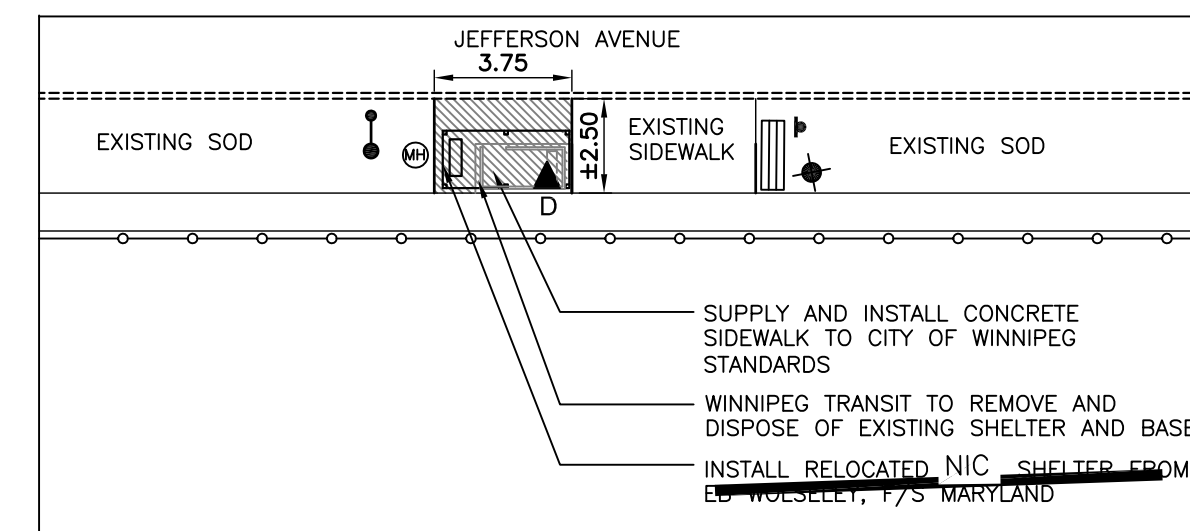

Eastbound Jefferson, N/S Teakwood
Stop 30414 Teakwood

LEGEND

EXISTING

- PROPERTY LINE
- EXISTING CURB
- EXISTING COBRA LIGHT POLE
- EXISTING HYDRANT
- MTS PHONE BOOTH
- WASTE RECEPTACLE
- EXISTING TREE TO REMAIN
- EXISTING SIDEWALK TO BE REMOVED
- EXISTING SIGN TO BE REMOVED
- EXISTING TRAFFIC SIGNAL
- EXISTING MAN HOLE

PROPOSED

- HOLLAND PAVERS
- PINNED CONCRETE CURB / CURB RENEWAL
- CONCRETE SIDEWALK
- SOD
- RELOCATED 5X11 DAYTECH
- CBS 5X11 SHELTER
- 5X11 DAYTECH SHELTER TO BE RELOCATED
- ALUMINUM SHELTER TO BE REMOVED
- DOOR LOCATION

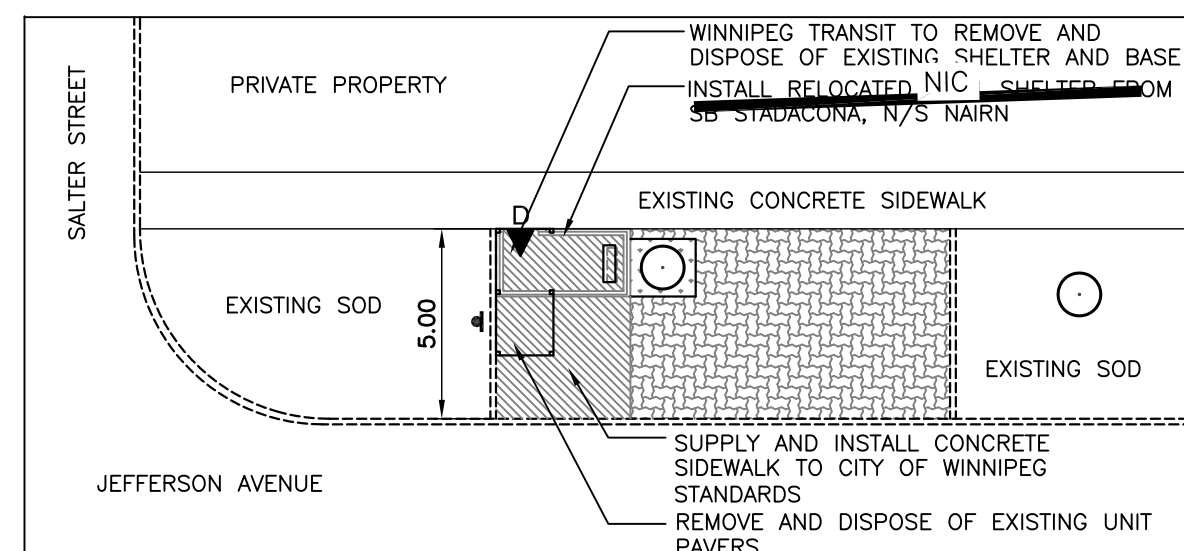

Eastbound Jefferson, N/S Salter
Stop 30141 Salter

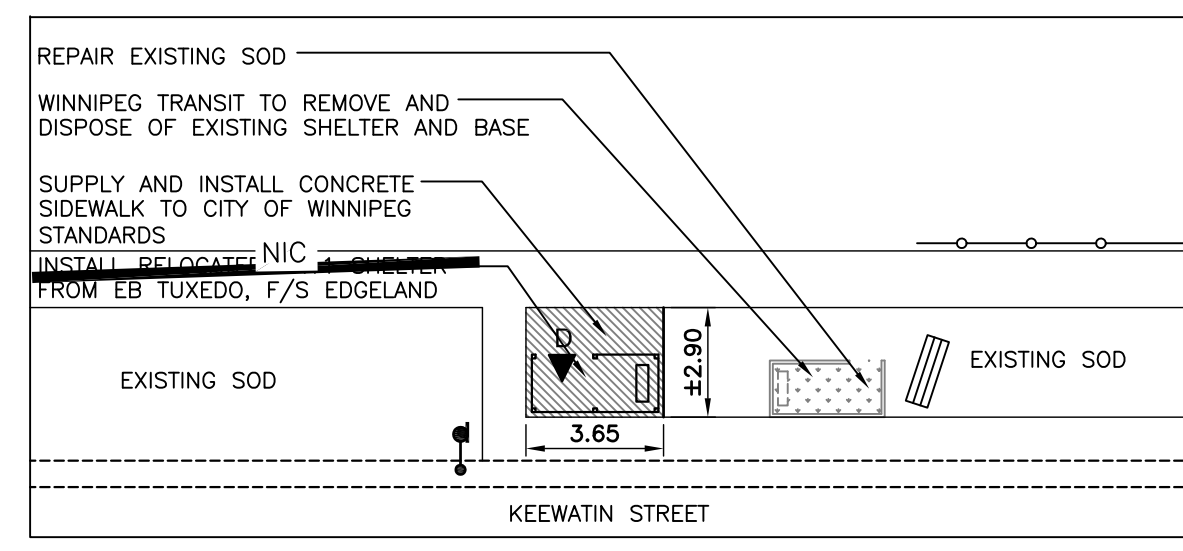

Southbound Keewatin, N/S Manitoba
Stop 30811 Manitoba

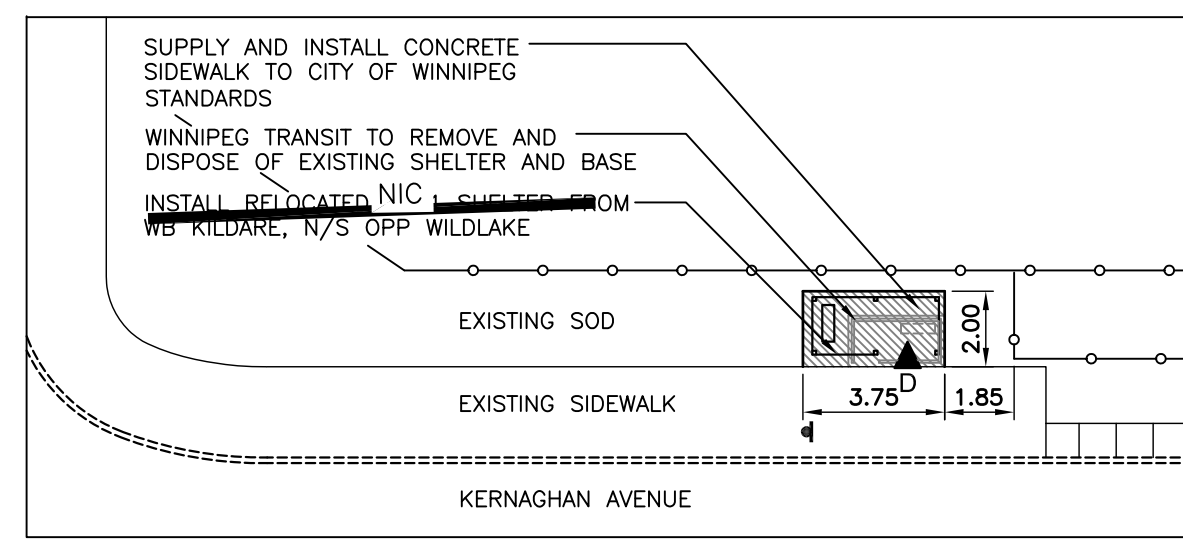

Westbound Kernaghan, N/S Plessis
Stop 40124 Plessis

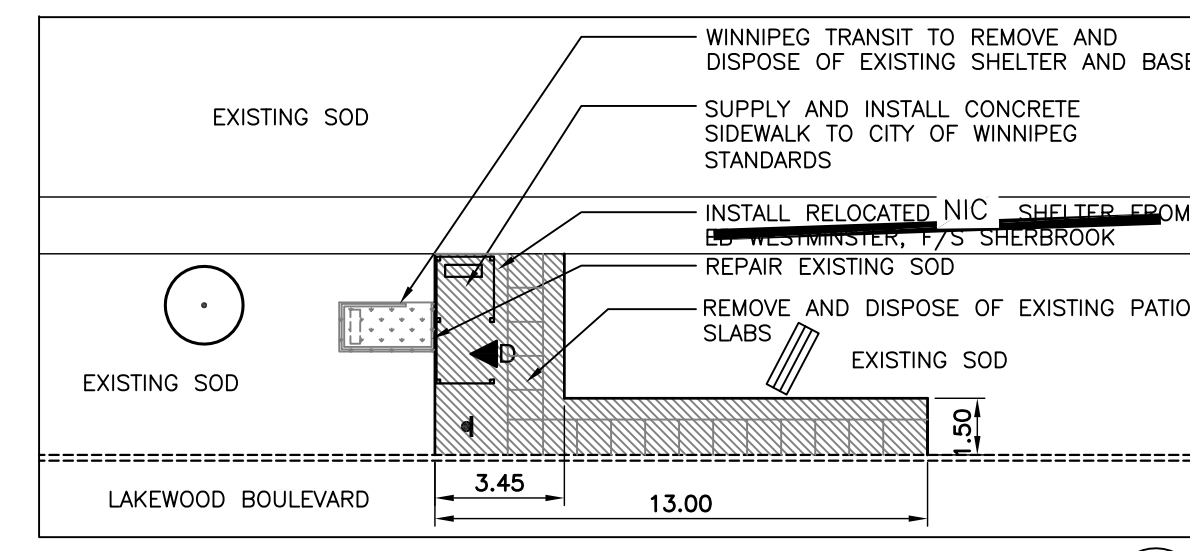

Southbound Lakewood, F/S Weatherstone
Stop 50312 Weatherstone

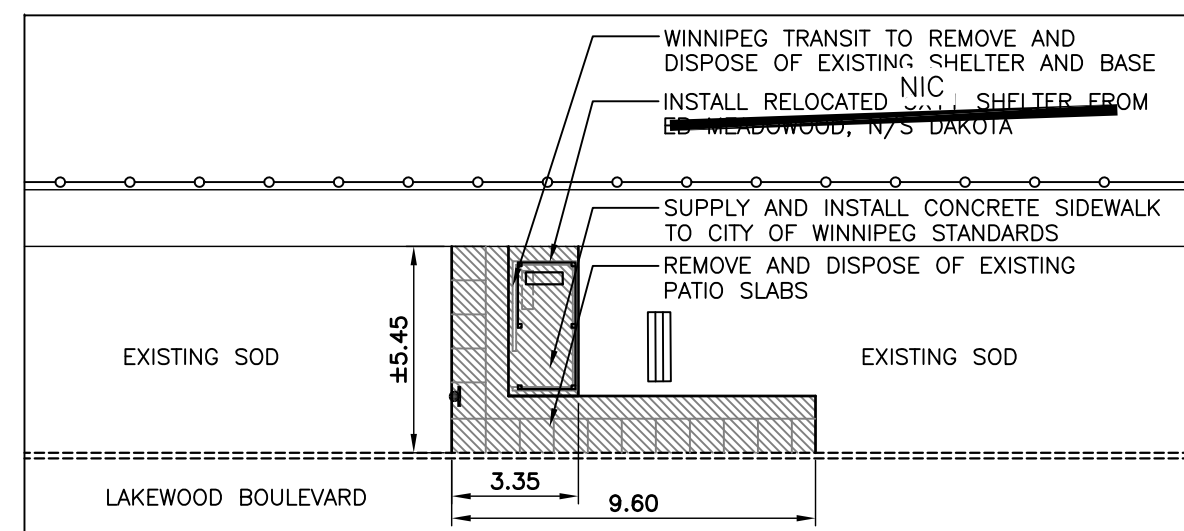

Southbound Lakewood, N/S Beaverhill
Stop 50367 Beaverhill

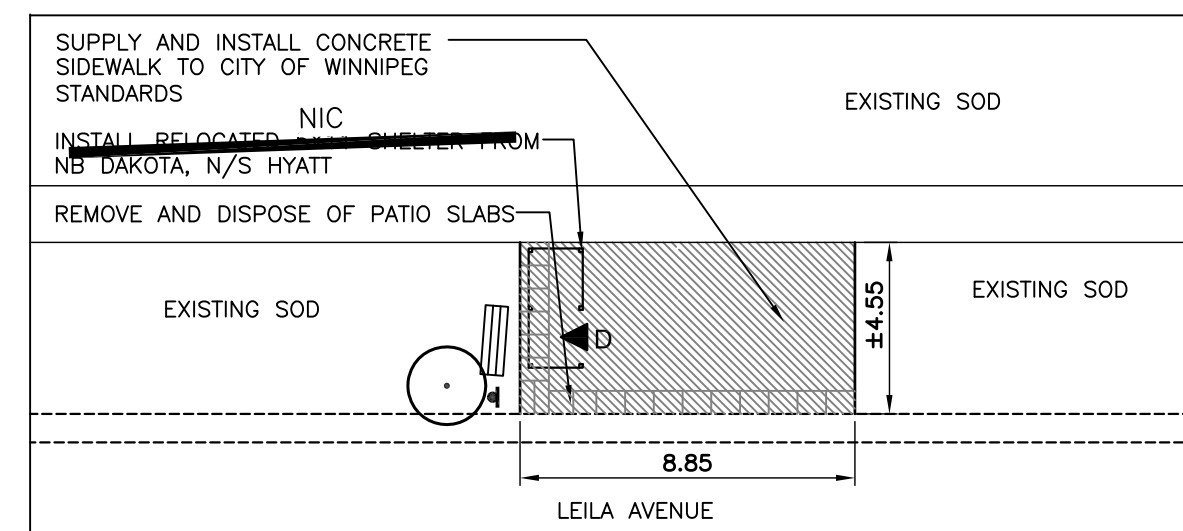

Westbound Leila, Opp Watson
Stop 30199 Watson

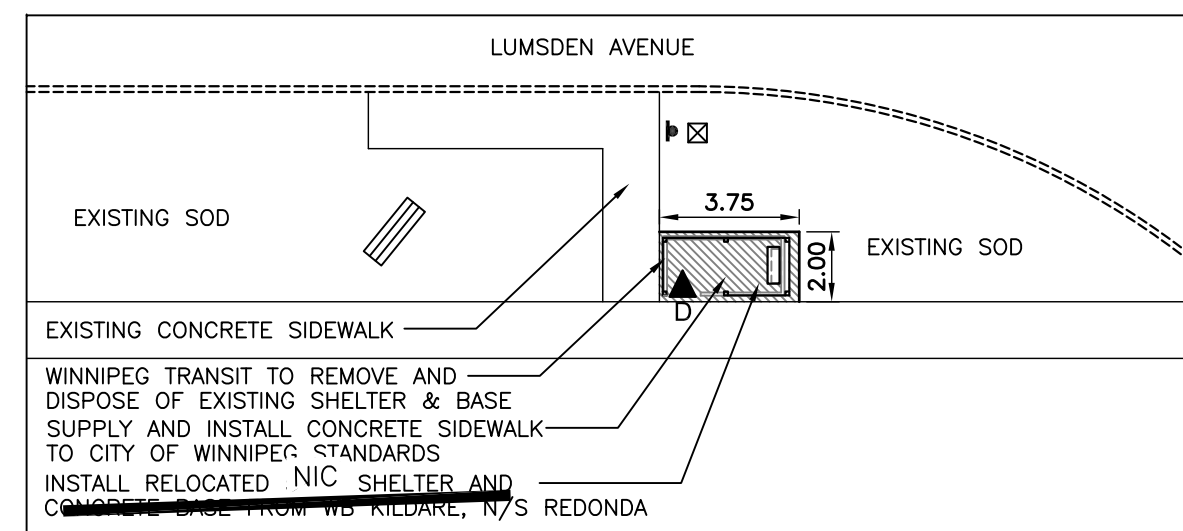

Eastbound Lumsden, N/S Cavalier
Stop 20342 Cavalier

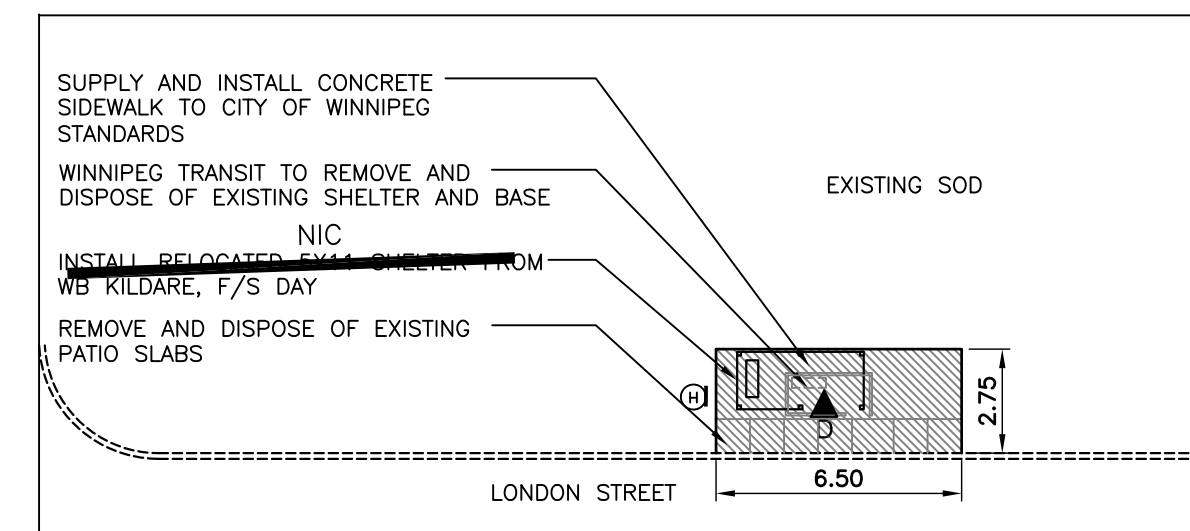

Southbound London, F/S Concordia
Stop 40316 Concordia

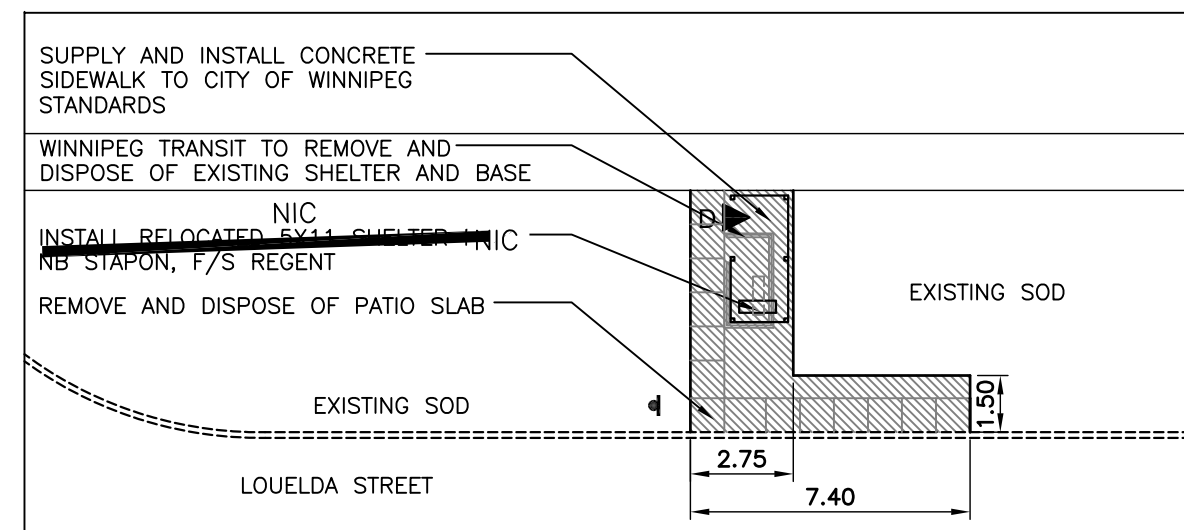

Southbound Louelda, N/S Concordia
Stop 40271 Concordia

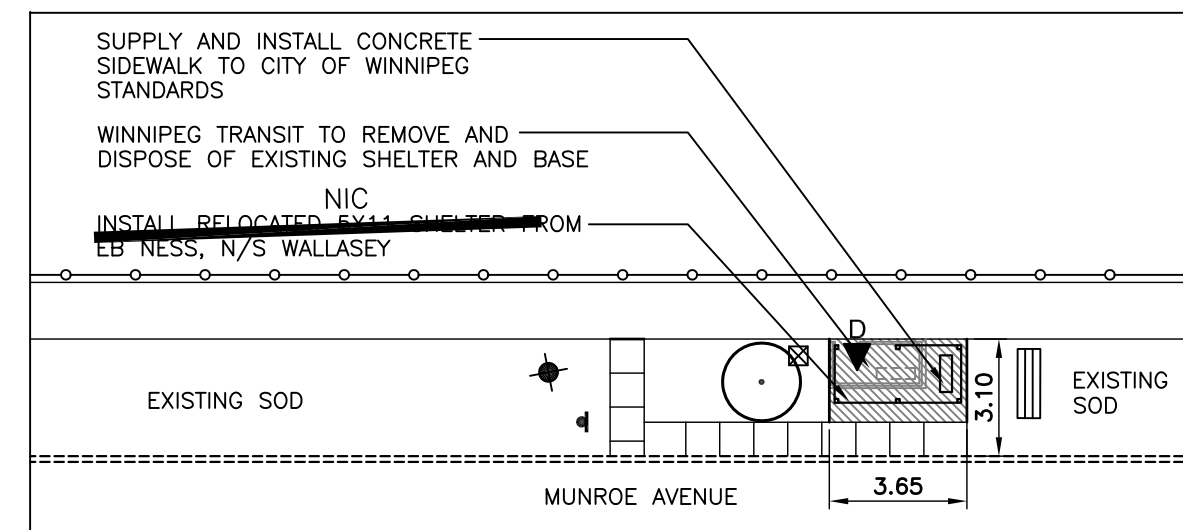

Westbound Munroe, N/S London
Stop 40312 London

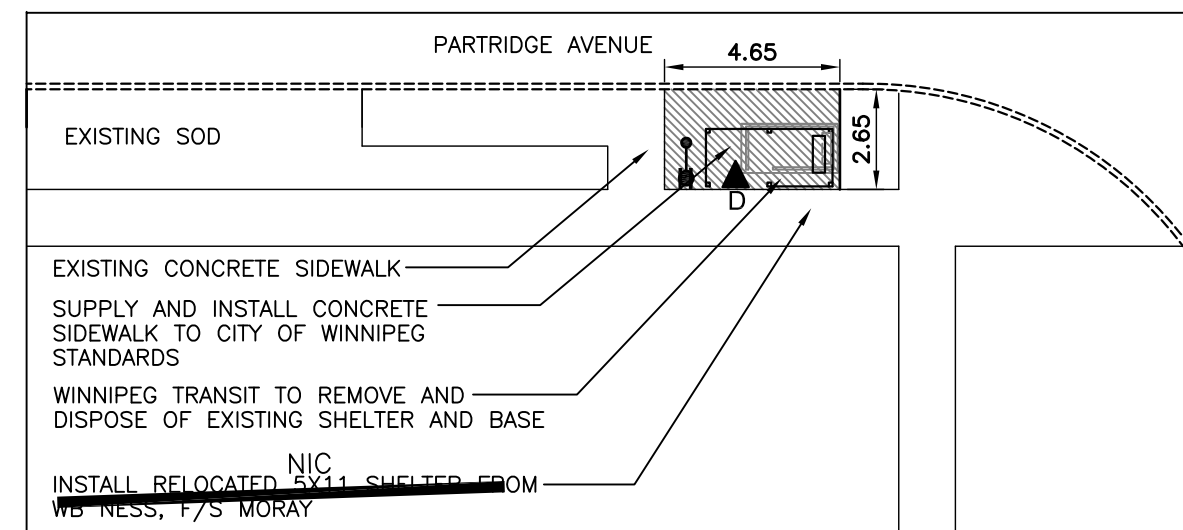

Eastbound Partridge, N/S Powers
Stop 30183 Powers

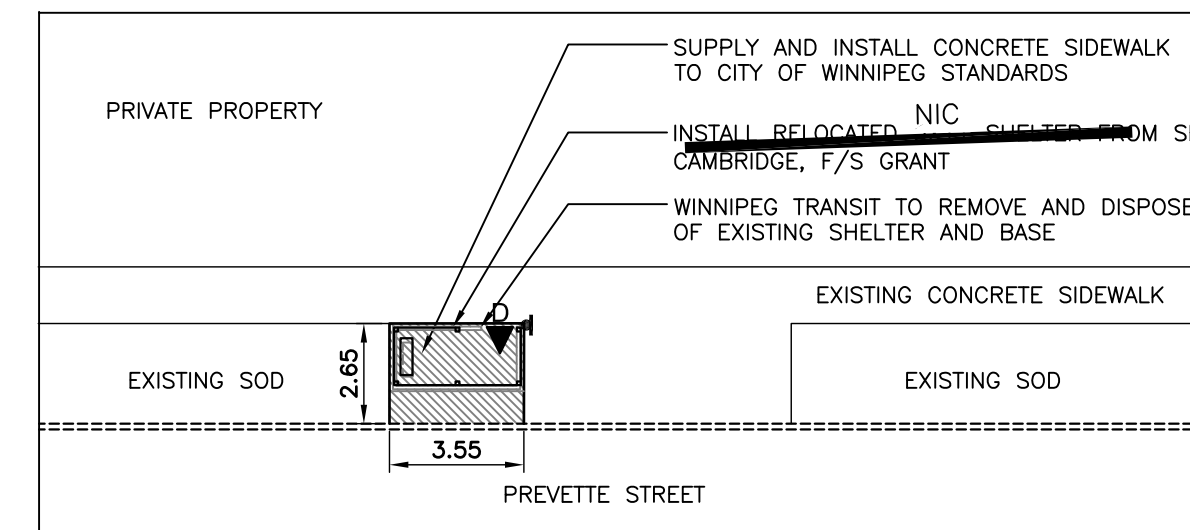

Southbound Prevette, F/S Munroe
Stop 40133 Prevette

No.	Revisions	Date	By

Date: 04-18-11 Scale: 1:200

Designed By: JW Drawn By: MH Checked By: JW

Seals

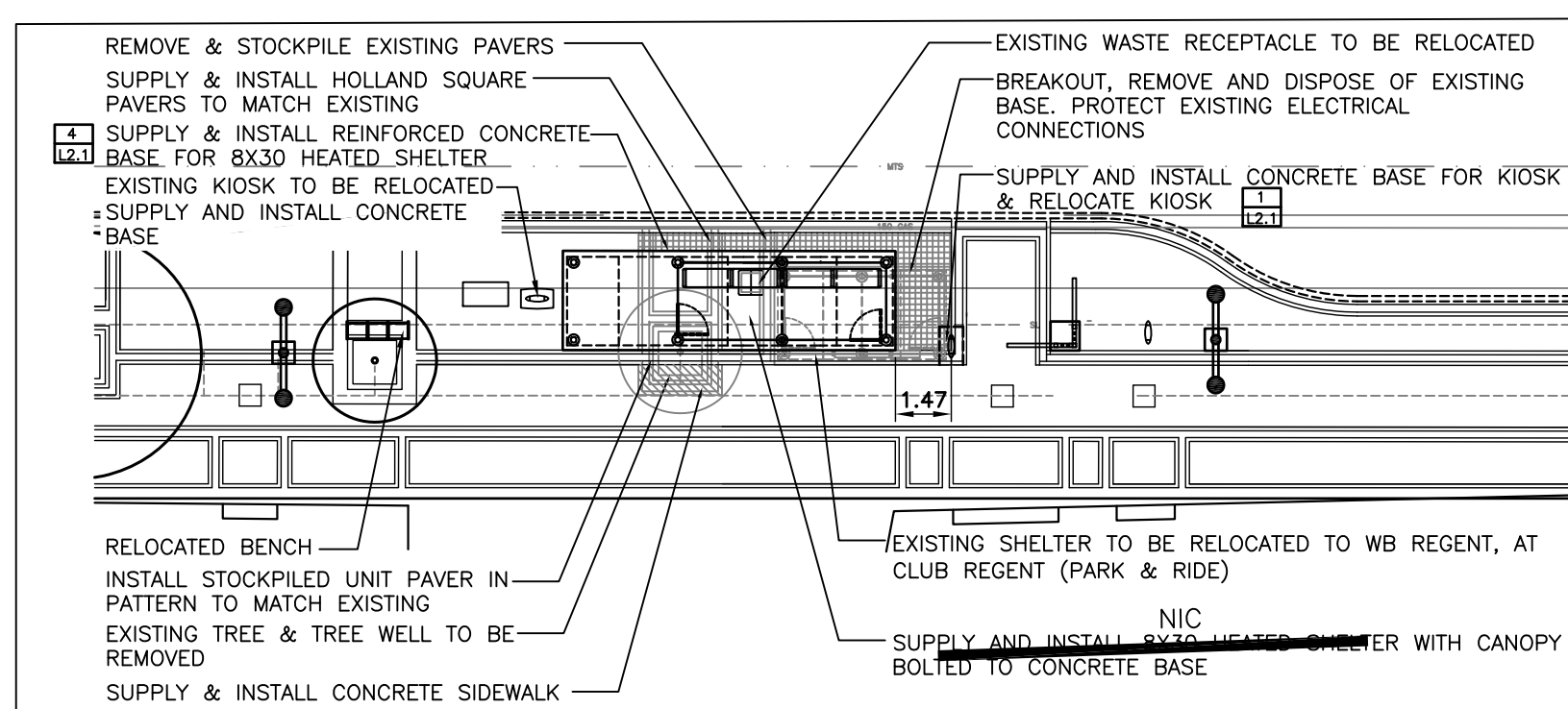

Eastbound Portage, N/S Edmonton
Stop 10581 Edmonton

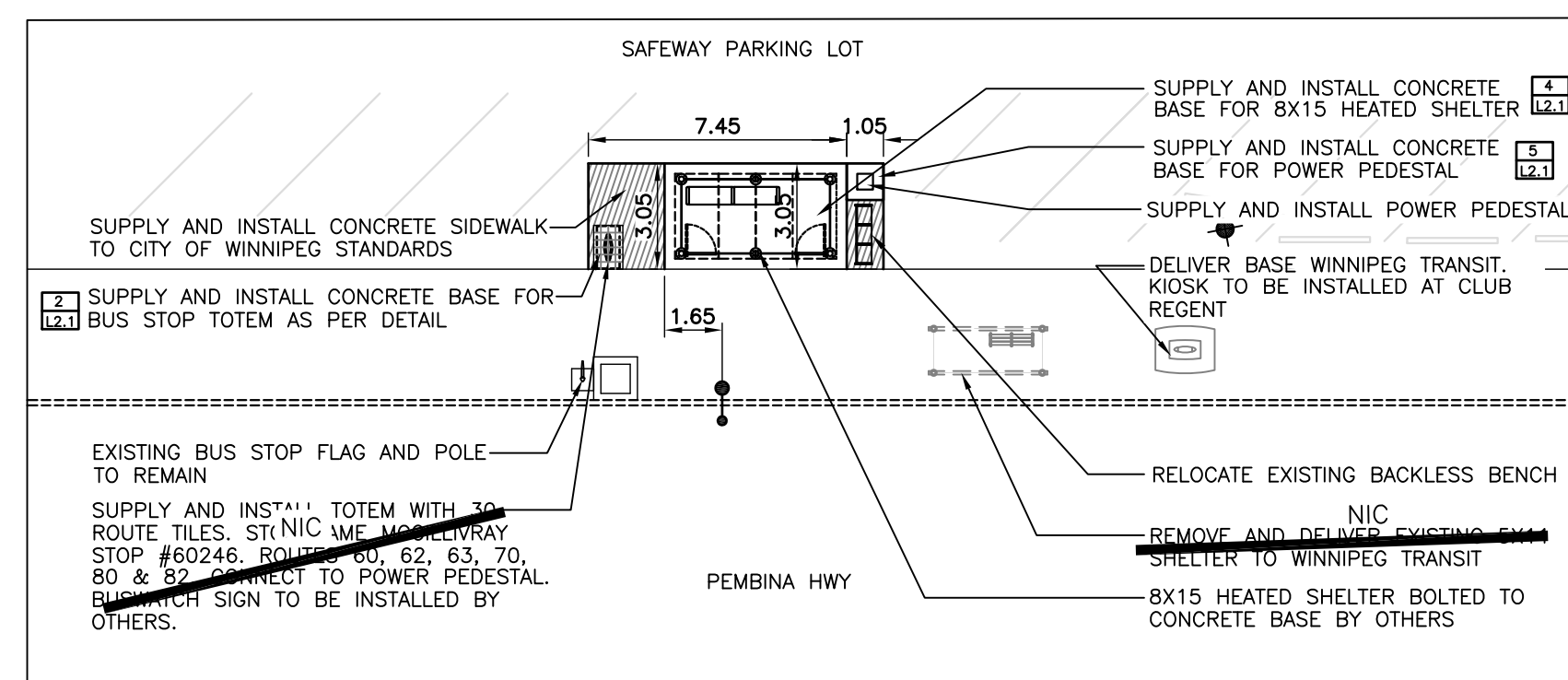

Southbound Pembina, F/S McGillivray
Stop 60246 McGillivray

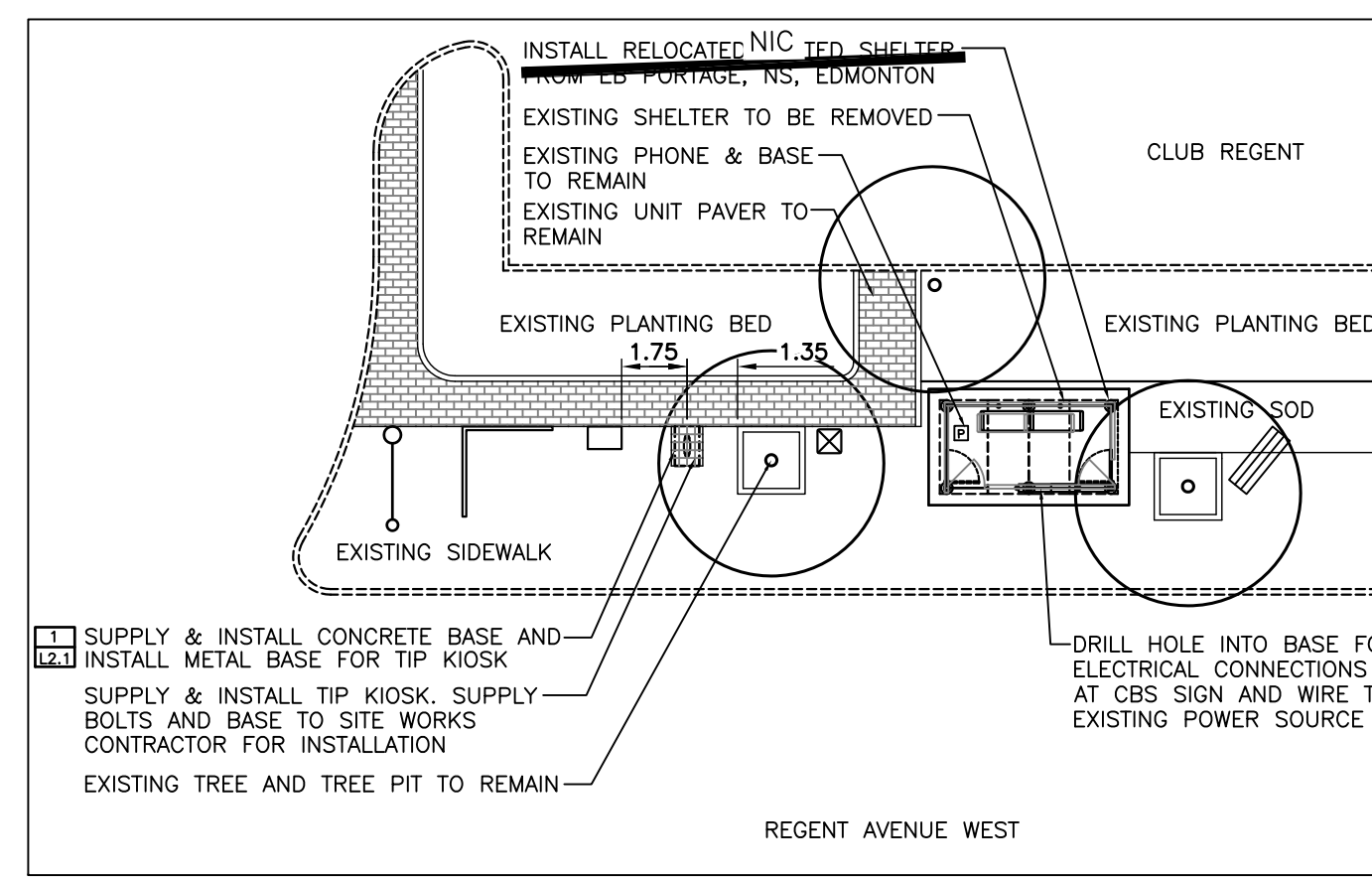

Westbound Regent, Club Regent
Stop 40174 Club Regent

McGOWAN RUSSELL
Client

WINNIPEG TRANSIT
Project Title

BUS STOP IMPROVEMENTS 2011

Sheet Title

SITE WORKS LAYOUT PLANS

Project No. 06-029 Drawing No. L1.3