



THE CITY OF WINNIPEG

BID OPPORTUNITY

BID OPPORTUNITY NO. 375-2011

**2011 RENEWAL AND NEW CONSTRUCTION OF SIDEWALKS, INSTALLATION OF
DETECTABLE WARNING SURFACE TILES AND ASSOCIATED WORKS**

TABLE OF CONTENTS

PART A - BID SUBMISSION

Form A: Bid	1
Form B: Prices	4
Form G1: Bid Bond and Agreement to Bond	11
Form G2: Irrevocable Standby Letter of Credit and Undertaking	13

PART B - BIDDING PROCEDURES

B1. Contract Title	1
B2. Submission Deadline	1
B3. Enquiries	1
B4. Addenda	1
B5. Substitutes	2
B6. Bid Components	3
B7. Bid	3
B8. Prices	4
B9. Qualification	4
B10. Bid Security	5
B11. Opening of Bids and Release of Information	6
B12. Irrevocable Bid	6
B13. Withdrawal of Bids	6
B14. Evaluation of Bids	7
B15. Award of Contract	8

PART C - GENERAL CONDITIONS

C0. General Conditions	1
------------------------	---

PART D - SUPPLEMENTAL CONDITIONS

General

D1. General Conditions	1
D2. Scope of Work	1
D3. Contract Administrator	2
D4. Contractor's Supervisor	2
D5. Notices	2
D6. Furnishing of Documents	3

Submissions

D7. Authority to Carry on Business	3
D8. Safe Work Plan	3
D9. Insurance	3
D10. Performance Security	4
D11. Subcontractor List	4
D12. Detailed Work Schedule	4

Schedule of Work

D13. Commencement	4
D14. Working Days	5
D15. Restricted Work Hours	5
D16. Work By Others	5
D17. Sequence of Work	6
D18. Critical Stages	6
D19. Substantial Performance	6
D20. Total Performance	6
D21. Liquidated Damages	7

Control of Work

D22. Job Meetings	7
-------------------	---

D23. Prime Contractor – The Workplace Safety and Health Act (Manitoba)	7
Warranty	
D24. Warranty	7
Form H1: Performance Bond	8
Form H2: Irrevocable Standby Letter of Credit	10
Form J: Subcontractor List	12

PART E - SPECIFICATIONS

General

E1. Applicable Specifications and Drawings	1
E2. Protection Of Existing Trees	1
E3. Traffic Control	2
E4. Traffic Management	2
E5. Water Obtained From the City	2
E6. Surface Restorations	2
E7. Recycled Concrete Base Course Material	3
E8. Salt Tolerant Grass Seeding	4
E9. Supply and Install Detectable Warning Surface Tiles	5
E10. Reinforced Concrete Tree Well Curb	18
E11. Monolithic Curb and 100mm Concrete Sidewalk with Block-outs for Pavers	19
E12. Paving Stones	19
E13. Salvage Existing Interlocking Paving Stones	20
E14. Tree Grates	20
E15. Base Course Material Use in the Exchange District	21
E16. Sidewalk Furniture and Appurtenances in the Exchange District	21
E17. Tree and Stump Removal	21
E18. Portage Avenue Work Hours	21

PART B - BIDDING PROCEDURES

B1. CONTRACT TITLE

- B1.1 2011 RENEWAL AND NEW CONSTRUCTION OF SIDEWALKS, INSTALLATION OF DETECTABLE WARNING SURFACE TILES AND ASSOCIATED WORKS

B2. SUBMISSION DEADLINE

- B2.1 The Submission Deadline is 12:00 noon Winnipeg time, July 8, 2011.
- B2.2 Bids determined by the Manager of Materials to have been received later than the Submission Deadline will not be accepted and will be returned upon request.
- B2.3 The Contract Administrator or the Manager of Materials may extend the Submission Deadline by issuing an addendum at any time prior to the time and date specified in B2.1.

B3. ENQUIRIES

- B3.1 All enquiries shall be directed to the Contract Administrator identified in D3.1.
- B3.2 If the Bidder finds errors, discrepancies or omissions in the Bid Opportunity, or is unsure of the meaning or intent of any provision therein, the Bidder shall notify the Contract Administrator of the error, discrepancy or omission, or request a clarification as to the meaning or intent of the provision at least five (5) Business Days prior to the Submission Deadline.
- B3.3 Responses to enquiries which, in the sole judgment of the Contract Administrator, require a correction to or a clarification of the Bid Opportunity will be provided by the Contract Administrator to all Bidders by issuing an addendum.
- B3.4 Responses to enquiries which, in the sole judgment of the Contract Administrator, do not require a correction to or a clarification of the Bid Opportunity will be provided by the Contract Administrator only to the Bidder who made the enquiry.
- B3.5 The Bidder shall not be entitled to rely on any response or interpretation received pursuant to B3 unless that response or interpretation is provided by the Contract Administrator in writing.

B4. ADDENDA

- B4.1 The Contract Administrator may, at any time prior to the Submission deadline, issue addenda correcting errors, discrepancies or omissions in the Bid Opportunity, or clarifying the meaning or intent of any provision therein.
- B4.2 The Contract Administrator will issue each addendum at least two (2) Business Days prior to the Submission Deadline, or provide at least two (2) Business Days by extending the Submission Deadline.
- B4.2.1 Addenda will be available on the Bid Opportunities page at The City of Winnipeg, Corporate Finance, Materials Management Division website at <http://www.winnipeg.ca/matmgt/bidopp.asp>
- B4.2.2 The Bidder is responsible for ensuring that he has received all addenda and is advised to check the Materials Management Division website for addenda regularly and shortly before the Submission Deadline, as may be amended by addendum.
- B4.3 The Bidder shall acknowledge receipt of each addendum in Paragraph 10 of Form A: Bid. Failure to acknowledge receipt of an addendum may render a Bid non-responsive.

B5. SUBSTITUTES

- B5.1 The Work is based on the Plant, Materials and methods specified in the Bid Opportunity.
- B5.2 Substitutions shall not be allowed unless application has been made to and prior approval has been granted by the Contract Administrator in writing.
- B5.3 Requests for approval of a substitute will not be considered unless received in writing by the Contract Administrator at least five (5) Business Days prior to the Submission Deadline.
- B5.4 The Bidder shall ensure that any and all requests for approval of a substitute:
- (a) provide sufficient information and details to enable the Contract Administrator to determine the acceptability of the Plant, Material or method as either an approved equal or alternative;
 - (b) identify any and all changes required in the applicable Work, and all changes to any other Work, which would become necessary to accommodate the substitute;
 - (c) identify any anticipated cost or time savings that may be associated with the substitute;
 - (d) certify that, in the case of a request for approval as an approved equal, the substitute will fully perform the functions called for by the general design, be of equal or superior substance to that specified, is suited to the same use and capable of performing the same function as that specified and can be incorporated into the Work, strictly in accordance with the proposed work schedule and the dates specified in the Supplemental Conditions for Substantial Performance and Total Performance;
 - (e) certify that, in the case of a request for approval as an approved alternative, the substitute will adequately perform the functions called for by the general design, be similar in substance to that specified, is suited to the same use and capable of performing the same function as that specified and can be incorporated into the Work, strictly in accordance with the proposed work schedule and the dates specified in the Supplemental Conditions for Substantial Performance and Total Performance.
- B5.5 The Contract Administrator, after assessing the request for approval of a substitute, may in his sole discretion grant approval for the use of a substitute as an “approved equal” or as an “approved alternative”, or may refuse to grant approval of the substitute.
- B5.6 The Contract Administrator will provide a response in writing, at least two (2) Business Days prior to the Submission Deadline, only to the Bidder who requested approval of the substitute.
- B5.6.1 The Bidder requesting and obtaining the approval of a substitute shall be entirely responsible for disseminating information regarding the approval to any person or persons he wishes to inform.
- B5.7 If the Contract Administrator approves a substitute as an “approved equal”, any Bidder may use the approved equal in place of the specified item.
- B5.8 If the Contract Administrator approves a substitute as an “approved alternative”, any Bidder bidding that approved alternative may base his Total Bid Price upon the specified item but may also indicate an alternative price based upon the approved alternative. Such alternatives will be evaluated in accordance with B14.
- B5.9 No later claim by the Contractor for an addition to the Total Bid Price because of any other changes in the Work necessitated by the use of an approved equal or an approved alternative will be considered.
- B5.10 Notwithstanding B5.2 to B5.9, in accordance with B6.6, deviations inconsistent with the Bid Opportunity document shall be evaluated in accordance with B14.1(a).

B6. BID COMPONENTS

- B6.1 The Bid shall consist of the following components:
- (a) Form A: Bid;
 - (b) Form B: Prices, hard copy;
 - (c) Bid Security;
 - (i) Form G1: Bid Bond and Agreement to Bond, or
Form G2: Irrevocable Standby Letter of Credit and Undertaking, or
a certified cheque or draft;
- B6.2 Further to B6.1, the Bidder should include the written correspondence from the Contract Administrator approving a substitute in accordance with B5.
- B6.3 All components of the Bid shall be fully completed or provided, and submitted by the Bidder no later than the Submission Deadline, with all required entries made clearly and completely, to constitute a responsive Bid.
- B6.4 The Bid shall be submitted enclosed and sealed in an envelope clearly marked with the Bid Opportunity number and the Bidder's name and address.
- B6.4.1 Samples or other components of the Bid which cannot reasonably be enclosed in the envelope may be packaged separately, but shall be clearly marked with the Bid Opportunity number, the Bidder's name and address, and an indication that the contents are part of the Bidder's Bid.
- B6.4.2 A hard copy of Form B: Prices must be submitted with the Bid. If there is any discrepancy between the Adobe PDF version of Form B: Prices and the Microsoft Excel version of Form B: Prices, the PDF version shall take precedence.
- B6.5 Bidders are advised not to include any information/literature except as requested in accordance with B6.1.
- B6.6 Bidders are advised that inclusion of terms and conditions inconsistent with the Bid Opportunity document, including the General Conditions, will be evaluated in accordance with B14.1(a).
- B6.7 Bids submitted by facsimile transmission (fax) or internet electronic mail (e-mail) will not be accepted.
- B6.8 Bids shall be submitted to:
- The City of Winnipeg
Corporate Finance Department
Materials Management Division
185 King Street, Main Floor
Winnipeg MB R3B 1J1

B7. BID

- B7.1 The Bidder shall complete Form A: Bid, making all required entries.
- B7.2 Paragraph 2 of Form A: Bid shall be completed in accordance with the following requirements:
- (a) if the Bidder is a sole proprietor carrying on business in his own name, his name shall be inserted;
 - (b) if the Bidder is a partnership, the full name of the partnership shall be inserted;
 - (c) if the Bidder is a corporation, the full name of the corporation shall be inserted;

- (d) if the Bidder is carrying on business under a name other than his own, the business name and the name of every partner or corporation who is the owner of such business name shall be inserted.

B7.2.1 If a Bid is submitted jointly by two or more persons, each and all such persons shall identify themselves in accordance with B7.2.

B7.3 In Paragraph 3 of Form A: Bid, the Bidder shall identify a contact person who is authorized to represent the Bidder for purposes of the Bid.

B7.4 Paragraph 12 of Form A: Bid shall be signed in accordance with the following requirements:

- (a) if the Bidder is a sole proprietor carrying on business in his own name, it shall be signed by the Bidder;
- (b) if the Bidder is a partnership, it shall be signed by the partner or partners who have authority to sign for the partnership;
- (c) if the Bidder is a corporation, it shall be signed by its duly authorized officer or officers and the corporate seal, if the corporation has one, shall be affixed;
- (d) if the Bidder is carrying on business under a name other than his own, it shall be signed by the registered owner of the business name, or by the registered owner's authorized officials if the owner is a partnership or a corporation.

B7.4.1 The name and official capacity of all individuals signing Form A: Bid should be printed below such signatures.

B7.5 If a Bid is submitted jointly by two or more persons, the word "Bidder" shall mean each and all such persons, and the undertakings, covenants and obligations of such joint Bidders in the Bid and the Contract, when awarded, shall be both joint and several.

B8. PRICES

B8.1 The Bidder shall state a price in Canadian funds for each item of the Work identified on Form B: Prices.

B8.1.1 For the convenience of Bidders, and pursuant to B6.4.2 and B14.4.3, an electronic spreadsheet Form B: Prices in Microsoft Excel (.xls) format is available along with the Adobe PDF documents for this Bid Opportunity on the Bid Opportunities page at the Materials Management Division website at <http://www.winnipeg.ca/matmgt>

B8.2 The quantities listed on Form B: Prices are to be considered approximate only. The City will use said quantities for the purpose of comparing Bids.

B8.3 The quantities for which payment will be made to the Contractor are to be determined by the Work actually performed and completed by the Contractor, to be measured as specified in the applicable Specifications.

B8.4 Payments to Non-Resident Contractors are subject to Non-Resident Withholding Tax pursuant to the Income Tax Act (Canada).

B9. QUALIFICATION

B9.1 The Bidder shall:

- (a) undertake to be in good standing under The Corporations Act (Manitoba), or properly registered under The Business Names Registration Act (Manitoba), or otherwise properly registered, licensed or permitted by law to carry on business in Manitoba; and
- (b) be financially capable of carrying out the terms of the Contract; and
- (c) have all the necessary experience, capital, organization, and equipment to perform the Work in strict accordance with the terms and provisions of the Contract.

- B9.2 The Bidder and any proposed Subcontractor (for the portion of the Work proposed to be subcontracted to them) shall:
- (a) be responsible and not be suspended, debarred or in default of any obligations to the City. A list of suspended or debarred individuals and companies is available on the Information Connection page at The City of Winnipeg, Corporate Finance, Materials Management Division website at <http://www.winnipeg.ca/matmgt/debar.stm>
- B9.3 The Bidder and/or any proposed Subcontractor (for the portion of the Work proposed to be subcontracted to them) shall:
- (a) have successfully carried out work similar in nature, scope and value to the Work; and
 - (b) be fully capable of performing the Work required to be in strict accordance with the terms and provisions of the Contract; and
 - (c) have a written workplace safety and health program if required pursuant to The Workplace Safety and Health Act (Manitoba);
- B9.4 Further to B9.3(c), the Bidder shall, within five (5) Business Days of a request by the Contract Administrator, provide proof satisfactory to the Contract Administrator that the Bidder/Subcontractor has a workplace safety and health program meeting the requirements of The Workplace Safety and Health Act (Manitoba), by providing:
- (a) a valid COR certification number under the Certificate of Recognition (COR) Program administered by the Manitoba Construction Safety Association or by the Manitoba Heavy Construction Association's Safety, Health and Environment Program; or
 - (b) a report or letter to that effect from an independent reviewer acceptable to the City. (A list of acceptable reviewers and the review template are available on the Information Connection page at The City of Winnipeg, Corporate Finance, Materials Management Division website at <http://www.winnipeg.ca/matmgt>)
- B9.5 The Bidder shall submit, within three (3) Business Days of a request by the Contract Administrator, proof satisfactory to the Contract Administrator of the qualifications of the Bidder and of any proposed Subcontractor.
- B9.6 The Bidder shall provide, on the request of the Contract Administrator, full access to any of the Bidder's equipment and facilities to confirm, to the Contract Administrator's satisfaction, that the Bidder's equipment and facilities are adequate to perform the Work.

B10. BID SECURITY

- B10.1 The Bidder shall provide bid security in the form of:
- (a) a bid bond, in the amount of at least ten percent (10%) of the Total Bid Price, and agreement to bond of a company registered to conduct the business of a surety in Manitoba, in the form included in the Bid Submission (Form G1: Bid Bond and Agreement to Bond); or
 - (b) an irrevocable standby letter of credit, in the amount of at least ten percent (10%) of the Total Bid Price, and undertaking issued by a bank or other financial institution registered to conduct business in Manitoba and drawn on a branch located in Winnipeg, in the form included in the Bid Submission (Form G2: Irrevocable Standby Letter of Credit and Undertaking); or
 - (c) a certified cheque or draft payable to "The City of Winnipeg", in the amount of at least fifty percent (50%) of the Total Bid Price, drawn on a bank or other financial institution registered to conduct business in Manitoba.
- B10.1.1 If the Bidder submits alternative bids, the bid security shall be in the amount of the specified percentage of the highest Total Bid Price submitted.
- B10.1.2 All signatures on bid securities shall be original.
- B10.1.3 The Bidder shall sign the Bid Bond.

- B10.1.4 The Surety shall sign and affix its corporate seal on the Bid Bond and the Agreement to Bond.
- B10.2 The bid security of the successful Bidder and the next two lowest evaluated responsive and responsible Bidders will be released by the City when a Contract for the Work has been duly executed by the successful Bidder and the performance security furnished as provided herein. The bid securities of all other Bidders will be released when a Contract is awarded.
- B10.2.1 Where the bid security provided by the successful Bidder is in the form of a certified cheque or draft pursuant to B10.1(c), it will be deposited and retained by the City as the performance security and no further submission is required.
- B10.2.2 The City will not pay any interest on certified cheques or drafts furnished as bid security or subsequently retained as performance security.
- B10.3 The bid securities of all Bidders will be released by the City as soon as practicable following notification by the Contract Administrator to the Bidders that no award of Contract will be made pursuant to the Bid Opportunity.

B11. OPENING OF BIDS AND RELEASE OF INFORMATION

- B11.1 Bids will be opened publicly, after the Submission Deadline has elapsed, in the office of the Corporate Finance Department, Materials Management Division, or in such other office as may be designated by the Manager of Materials.
- B11.1.1 Bidders or their representatives may attend.
- B11.1.2 Bids determined by the Manager of Materials, or his designate, to not include the bid security specified in B10 will not be read out.
- B11.2 Following the submission deadline, the names of the Bidders and their Total Bid Prices (unevaluated, and pending review and verification of conformance with requirements) will be available on the Closed Bid Opportunities (or Public/Posted Opening & Award Results) page at The City of Winnipeg, Corporate Finance, Materials Management Division website at <http://www.winnipeg.ca/matmgt>
- B11.3 After award of Contract, the name(s) of the successful Bidder(s) and the Contract amount(s) will be available on the Closed Bid Opportunities (or Public/Posted Opening & Award Results) page at The City of Winnipeg, Corporate Finance, Materials Management Division website at <http://www.winnipeg.ca/matmgt>
- B11.4 The Bidder is advised that any information contained in any Bid may be released if required by City policy or procedures, by The Freedom of Information and Protection of Privacy Act (Manitoba), by other authorities having jurisdiction, or by law.

B12. IRREVOCABLE BID

- B12.1 The Bid(s) submitted by the Bidder shall be irrevocable for the time period specified in Paragraph 11 of Form A: Bid.
- B12.2 The acceptance by the City of any Bid shall not release the Bids of the next two lowest evaluated responsive Bidders and these Bidders shall be bound by their Bids on such Work until a Contract for the Work has been duly executed and the performance security furnished as herein provided, but any Bid shall be deemed to have lapsed unless accepted within the time period specified in Paragraph 11 of Form A: Bid.

B13. WITHDRAWAL OF BIDS

- B13.1 A Bidder may withdraw his Bid without penalty by giving written notice to the Manager of Materials at any time prior to the Submission Deadline.

- B13.1.1 Notwithstanding C23.3, the time and date of receipt of any notice withdrawing a Bid shall be the time and date of receipt as determined by the Manager of Materials.
- B13.1.2 The City will assume that any one of the contact persons named in Paragraph 3 of Form A: Bid or the Bidder's authorized representatives named in Paragraph 12 of Form A: Bid, and only such person, has authority to give notice of withdrawal.
- B13.1.3 If a Bidder gives notice of withdrawal prior to the Submission Deadline, the Manager of Materials will:
- (a) retain the Bid until after the Submission Deadline has elapsed;
 - (b) open the Bid to identify the contact person named in Paragraph 3 of Form A: Bid and the Bidder's authorized representatives named in Paragraph 12 of Form A: Bid; and
 - (c) if the notice has been given by any one of the persons specified in B13.1.3(b), declare the Bid withdrawn.
- B13.2 A Bidder who withdraws his Bid after the Submission Deadline but before his Bid has been released or has lapsed as provided for in B12.2 shall be liable for such damages as are imposed upon the Bidder by law and subject to such sanctions as the Chief Administrative Officer considers appropriate in the circumstances. The City, in such event, shall be entitled to all rights and remedies available to it at law, including the right to retain the Bidder's bid security.

B14. EVALUATION OF BIDS

- B14.1 Award of the Contract shall be based on the following bid evaluation criteria:
- (a) compliance by the Bidder with the requirements of the Bid Opportunity, or acceptable deviation therefrom (pass/fail);
 - (b) qualifications of the Bidder and the Subcontractors, if any, pursuant to B9 (pass/fail);
 - (c) Total Bid Price;
 - (d) economic analysis of any approved alternative pursuant to B5.
- B14.2 Further to B14.1(a), the Award Authority may reject a Bid as being non-responsive if the Bid is incomplete, obscure or conditional, or contains additions, deletions, alterations or other irregularities. The Award Authority may reject all or any part of any Bid, or waive technical requirements or minor informalities or irregularities, if the interests of the City so require.
- B14.3 Further to B14.1(b), the Award Authority shall reject any Bid submitted by a Bidder who does not demonstrate, in his Bid or in other information required to be submitted, that he is responsible and qualified.
- B14.4 Further to B14.1(c), the Total Bid Price shall be the sum of the quantities multiplied by the unit prices for each item shown on Form B: Prices.
- B14.4.1 If there is any discrepancy between the Total Bid Price written in figures, the Total Bid Price written in words and the sum of the quantities multiplied by the unit prices for each item, the sum of the quantities multiplied by the unit prices for each item shall take precedence.
- B14.4.2 Further to B14.1(a), in the event that a unit price is not provided on Form B: Prices, the City will determine the unit price by dividing the Amount (extended price) by the approximate quantity, for the purposes of evaluation and payment.
- B14.4.3 The electronic Form B: Prices and the formulas imbedded in that spreadsheet are only provided for the convenience of Bidders. The City makes no representations or warranties as to the correctness of the imbedded formulas. It is the Bidder's responsibility to ensure the extensions of the unit prices and the sum of Total Bid Price performed as a function of the formulas within the electronic Form B: Prices are correct.

B15. AWARD OF CONTRACT

- B15.1 The City will give notice of the award of the Contract or will give notice that no award will be made.
- B15.2 The City will have no obligation to award a Contract to a Bidder, even though one or all of the Bidders are determined to be responsible and qualified, and the Bids are determined to be responsive.
- B15.2.1 Without limiting the generality of B15.2, the City will have no obligation to award a Contract where:
- (a) the prices exceed the available City funds for the Work;
 - (b) the prices are materially in excess of the prices received for similar work in the past;
 - (c) the prices are materially in excess of the City's cost to perform the Work, or a significant portion thereof, with its own forces;
 - (d) only one Bid is received; or
 - (e) in the judgment of the Award Authority, the interests of the City would best be served by not awarding a Contract.
- B15.3 Where an award of Contract is made by the City, the award shall be made to the responsible and qualified Bidder submitting the lowest evaluated responsive Bid, in accordance with B14.
- B15.3.1 Following the award of contract, a Bidder will be provided with information related to the evaluation of his Bid upon written request to the Contract Administrator.

PART C - GENERAL CONDITIONS

C0. GENERAL CONDITIONS

- C0.1 The *General Conditions for Construction* (Revision 2006 12 15) are applicable to the Work of the Contract.
- C0.1.1 The *General Conditions for Construction* are available on the Information Connection page at The City of Winnipeg, Corporate Finance, Materials Management Division website at http://www.winnipeg.ca/matmgt/gen_cond.stm
- C0.2 A reference in the Bid Opportunity to a section, clause or subclause with the prefix “**C**” designates a section, clause or subclause in the *General Conditions for Construction*.

PART D - SUPPLEMENTAL CONDITIONS

GENERAL

D1. GENERAL CONDITIONS

D1.1 In addition to the General Conditions for Construction, these Supplemental Conditions are applicable to the Work of the Contract.

D2. SCOPE OF WORK

D2.1 The Work to be done under the Contract shall consist of the installation and construction of concrete sidewalks and associated works:

- (a) Downtown Exchange District Sidewalk Renewal as identified on Form B as "Part A"
 - (i) Bannatyne Avenue from Main Street to Waterfront Drive
- (b) Construction of New 100mm Regional Sidewalk as identified on Form B as "Part B"
 - (i) Academy Road (South Side) from Stafford Street to Wellington Crescent
- (c) Installation of Detectable Warning Surface Tiles as identified on Form B as "Part C"
 - (i) Portage Avenue at Fort Street/Notre Dame Avenue, Garry Street and Smith Street. and various other locations.

D2.2 The major components of the Work are as follows:

- (a) Downtown Exchange District Sidewalk Renewal
 - (i) Removal and Storage of Sidewalk Furniture and Appurtenances
 - (ii) Removal of Existing Interlocking Paving Stone Sidewalk
 - (iii) Removal of Existing Barrier Curb
 - (iv) Installation of Monolithic Curb and 100mm Concrete Sidewalk with Reveals for Pavers
 - (v) Installation of Interlocking Paving Stones
 - (vi) Installation of Detectable Warning Surface Tiles
 - (vii) Construction of Asphalt Patches
 - (viii) Replacement of Sidewalk Furniture and Appurtenances
- (b) New 100mm Regional Sidewalk
 - (i) Tree Removal
 - (ii) Stump Grinding
 - (iii) Removal of Existing Barrier Curb
 - (iv) Excavation
 - (v) Compaction of Existing Subgrade
 - (vi) Supplying and Placing Base Course
 - (vii) Construction of Monolithic Curb and Sidewalk
 - (viii) Boulevard Grading
 - (ix) Sodding/Seeding
- (c) Installation of Detectable Warning Surface Tiles
 - (i) Removal of Existing Curb and Sidewalk
 - (ii) Installation of Detectable Warning Surface Tiles and Curb

D3. CONTRACT ADMINISTRATOR

D3.1 The Contract Administrator is:

Gary Campbell, C.E.T.
Technologist III
106 – 1155 Pacific Avenue
Winnipeg, MB
R3E 3P1

Telephone No. (204) 794-4379
Facsimile No. (204) 986-5302

D3.2 At the pre-construction meeting, the Contract Administrator will identify additional personnel representing the Contract Administrator and their respective roles and responsibilities for the Work.

D4. CONTRACTOR'S SUPERVISOR

D4.1 At the pre-construction meeting, the Contractor shall identify his designated supervisor and any additional personnel representing the Contractor and their respective roles and responsibilities for the Work.

D4.2 At least two (2) business days prior to the commencement of any Work on the site, the Contractor shall provide the Contract Administrator with a phone number where the supervisor identified in D4.1 or an alternate can be contacted twenty-four (24) hours a day to respond to an emergency.

D5. NOTICES

D5.1 Except as provided for in C23.2.2, all notices, requests, nominations, proposals, consents, approvals, statements, authorizations, documents or other communications to the Contractor shall be sent to the address or facsimile number identified by the Contractor in Paragraph 2 of Form A: Bid.

D5.2 All notices, requests, nominations, proposals, consents, approvals, statements, authorizations, documents or other communications to the City, except as expressly otherwise required in D5.3, D5.4 or elsewhere in the Contract, shall be sent to the attention of the Contract Administrator at the address or facsimile number identified in D3.1.

D5.3 Notwithstanding C21., all notices of appeal to the Chief Administrative Officer shall be sent to the attention of the Chief Financial Officer at the following facsimile number:

The City of Winnipeg
Chief Financial Officer
Facsimile No.: (204) 949-1174

D5.4 All notices, requests, nominations, proposals, consents, approvals, statements, authorizations, documents or other communications required to be submitted or returned to the City Solicitor shall be sent to the following address or facsimile number:

The City of Winnipeg
Legal Services Department
Attn: Director of Legal Services
185 King Street, 3rd Floor
Winnipeg MB R3B 1J1
Facsimile No.: (204) 947-9155

D6. FURNISHING OF DOCUMENTS

- D6.1 Upon award of the Contract, the Contractor will be provided with five (5) complete sets of the Bid Opportunity. If the Contractor requires additional sets of the Bid Opportunity, they will be supplied to him at cost.

SUBMISSIONS

D7. AUTHORITY TO CARRY ON BUSINESS

- D7.1 The Contractor shall be in good standing under The Corporations Act (Manitoba), or properly registered under The Business Names Registration Act (Manitoba), or otherwise properly registered, licensed or permitted by law to carry on business in Manitoba, or if the Contractor does not carry on business in Manitoba, in the jurisdiction where the Contractor does carry on business, throughout the term of the Contract, and shall provide the Contract Administrator with evidence thereof upon request.

D8. SAFE WORK PLAN

- D8.1 The Contractor shall provide the Contract Administrator with a Safe Work Plan at least five (5) Business Days prior to the commencement of any Work on the Site but in no event later than the date specified in C4.1 for the return of the executed Contract.
- D8.2 The Safe Work Plan shall be prepared and submitted in the format shown in the City's template which is available on the Information Connection page at The City of Winnipeg, Corporate Finance, Materials Management Division website at <http://www.winnipeg.ca/matmgt/safety/default.stm>

D9. INSURANCE

- D9.1 The Contractor shall provide and maintain the following insurance coverage:
- (a) commercial general liability insurance, in the amount of at least two million dollars (\$2,000,000.00) inclusive, with The City of Winnipeg added as an additional insured, with a cross-liability clause, such liability policy to also contain contractual liability, unlicensed motor vehicle liability, non-owned automobile liability, broad form property damage cover and products and completed operations, to remain in place at all times during the performance of the Work and throughout the warranty period;
 - (b) automobile liability insurance for owned automobiles used for or in connection with the Work in the amount of at least two million dollars (\$2,000,000.00) at all times during the performance of the Work and until the date of Total Performance;
 - (c) an all risks Installation Floater carrying adequate limits to cover all machinery, equipment, supplies and/or materials intended to enter into and form part of any installation.
- D9.2 Deductibles shall be borne by the Contractor.
- D9.3 The Contractor shall provide the City Solicitor with a certificate(s) of insurance, in a form satisfactory to the City Solicitor, at least two (2) Business Days prior to the commencement of any Work but in no event later than the date specified in the C4.1 for the return of the executed Contract.
- D9.4 The Contractor shall not cancel, materially alter, or cause each policy to lapse without providing at least thirty (30) Calendar Days prior written notice to the Contract Administrator.

D10. PERFORMANCE SECURITY

- D10.1 The Contractor shall provide and maintain performance security until the expiration of the warranty period in the form of:
- (a) a performance bond of a company registered to conduct the business of a surety in Manitoba, in the form attached to these Supplemental Conditions (Form H1: Performance Bond), in the amount of fifty percent (50%) of the Contract Price; or
 - (b) an irrevocable standby letter of credit issued by a bank or other financial institution registered to conduct business in Manitoba and drawn on a branch located in Winnipeg, in the form attached to these Supplemental Conditions (Form H2: Irrevocable Standby Letter of Credit), in the amount of fifty percent (50%) of the Contract Price; or
 - (c) a certified cheque or draft payable to "The City of Winnipeg", drawn on a bank or other financial institution registered to conduct business in Manitoba, in the amount of fifty percent (50%) of the Contract Price.
- D10.1.1 Where the performance security is in the form of a certified cheque or draft, it will be deposited by the City. The City will not pay any interest on certified cheques or drafts furnished as performance security.
- D10.2 If the bid security provided in his Bid was not a certified cheque or draft pursuant to B10.1(c), the Contractor shall provide the City Solicitor with the required performance security within seven (7) Calendar Days of notification of the award of the Contract by way of letter of intent and prior to the commencement of any Work on the Site and in no event later than the date specified in the C4.1 for the return of the executed Contract.

D11. SUBCONTRACTOR LIST

- D11.1 The Contractor shall provide the Contract Administrator with a complete list of the Subcontractors whom the Contractor proposes to engage (Form J: Subcontractor List) at or prior to a pre-construction meeting, or at least two (2) Business Days prior to the commencement of any Work on the Site but in no event later than the date specified in the C4.1 for the return of the executed Contract.

D12. DETAILED WORK SCHEDULE

- D12.1 The Contractor shall provide the Contract Administrator with a detailed work schedule at least two (2) Business Days prior to the commencement of any Work on the Site but in no event later than the date specified in the General Conditions for the return of the executed Contract.
- D12.2 The detailed work schedule shall consist of the following:
- (a) a Gantt chart for the Work acceptable to the Contract Administrator.
- D12.3 Further to D12.2(a), the Gantt chart shall show the time on a weekly basis, required to carry out the Work of each trade, or specification division. The time shall be on the horizontal axis, and the type of trade shall be on the vertical axis

SCHEDULE OF WORK

D13. COMMENCEMENT

- D13.1 The Contractor shall not commence any Work until he is in receipt of a letter of intent from the Award Authority authorizing the commencement of the Work.
- D13.2 The Contractor shall not commence any Work on the Site until:
- (a) the Contract Administrator has confirmed receipt and approval of:
 - (i) evidence of authority to carry on business specified in D7;
 - (ii) evidence of the workers compensation coverage specified in C6.15;

- (iii) the twenty-four (24) hour emergency response phone number specified in D4.2.
 - (iv) the Safe Work Plan specified in D8;
 - (v) evidence of the insurance specified in D9;
 - (vi) the performance security specified in D10;
 - (vii) the subcontractor list specified in D11;
 - (viii) the detailed work schedule specified in D12; and
- (b) the Contractor has attended a pre-construction meeting with the Contract Administrator, or the Contract Administrator has waived the requirement for a pre-construction meeting.

D13.3 The Contractor shall commence the Work on the Site within seven (7) Working Days of receipt of the letter of intent.

D13.4 The City intends to award this Contract by August 5, 2011.

D13.4.1 If the actual date of award is later than the intended date, the dates specified for Critical Stages, Substantial Performance, and Total Performance will be adjusted by the difference between the aforementioned intended and actual dates.

D14. WORKING DAYS

D14.1 Further to C1.1(gg);

D14.1.1 The Contract Administrator will determine daily if a Working Day has elapsed and will record his assessment. On a weekly basis the Contract Administrator will provide the Contractor with a record of the Working Days assessed for the preceding week. The Contractor shall sign each report signifying that he agrees with the Contract Administrator's determination of the Working Days assessed for the report period.

D14.1.2 Work done to restore the Site to a condition suitable for Work, shall not be considered "work" as defined in the definition of a Working Day.

D14.1.3 When the Work includes two or more major types of Work that can be performed under different atmospheric conditions, the Contract Administrator shall consider all major types of Work in determining whether the Contractor was able to work in assessing Working Days.

D15. RESTRICTED WORK HOURS

D15.1 Further to clause 3.10 of CW 1130, the Contractor shall require written permission forty-eight (48) hours in advance from the Contract Administrator for any work to be performed between 2000 hours and 0700 hours, or on Saturdays, Sundays, Statutory Holidays and or Civic Holidays.

D15.2 The following work hour restrictions shall also apply:

- (a) The Contractor shall not be allowed to occupy a Traffic Lane on the Priority I Streets during Peak Traffic Hours between 07:00 – 09:00 and 15:30 – 17:30 Monday through Friday.

D16. WORK BY OTHERS

D16.1 Work by others on or near the Site will include but not necessarily be limited to:

- (a) City of Winnipeg Traffic Signals;
- (b) City of Winnipeg Geomatics;
- (c) Manitoba Hydro.
- (d) MTS Allstream

D17. SEQUENCE OF WORK

D17.1 Further to C6.1, the sequence of work shall comply with the following:

D17.1.1 Providing that the Work on each street is completed in a similar order to the order that the Work was commenced in, the Contractor will be permitted to have a maximum of three (3) streets under construction at any one time. Completion of a street means that all of the necessary concrete, asphalt including approaches and landscaping Work is completed to the satisfaction of the Contract Administrator.

D17.1.2 Where the Contractor utilizes two (2) or more crews that work independently on the same major component of the Work as identified in D2, the Contract Administrator may approve an increase to the maximum number of streets under construction at any time.

D17.1.3 Placing the topsoil and finished grading of all boulevard and median areas shall be completed prior to commencing construction of asphaltic concrete overlays, including scratch courses.

D18. CRITICAL STAGES

D18.1 The Contractor shall achieve critical stages of the Work in accordance with the following requirements:

- (a) Bannatyne Avenue from Main Street to Waterfront Drive must be completed by September 16, 2011
- (b) Academy Road from Stafford Street to Wellington Crescent must be completed by October 21, 2011
- (c) Portage Avenue, Various Locations must be completed by October 21, 2011

D19. SUBSTANTIAL PERFORMANCE

D19.1 The Contractor shall achieve Substantial Performance within forty five (45) consecutive Working Days of the commencement of the Work as specified in D13.

D19.2 When the Contractor considers the Work to be substantially performed, the Contractor shall arrange, attend and assist in the inspection of the Work with the Contract Administrator for purposes of verifying Substantial Performance. Any defects or deficiencies in the Work noted during that inspection shall be remedied by the Contractor at the earliest possible instance and the Contract Administrator notified so that the Work can be re-inspected.

D19.3 The date on which the Work has been certified by the Contract Administrator as being substantially performed to the requirements of the Contract through the issue of a certificate of Substantial Performance is the date on which Substantial Performance has been achieved.

D20. TOTAL PERFORMANCE

D20.1 The Contractor shall achieve Total Performance within fifty (50) consecutive Working Days of the commencement of the Work as specified in D13.

D20.2 When the Contractor or the Contract Administrator considers the Work to be totally performed, the Contractor shall arrange, attend and assist in the inspection of the Work with the Contract Administrator for purposes of verifying Total Performance. Any defects or deficiencies in the Work noted during that inspection shall be remedied by the Contractor at the earliest possible instance and the Contract Administrator notified so that the Work can be re-inspected.

D20.3 The date on which the Work has been certified by the Contract Administrator as being totally performed to the requirements of the Contract through the issue of a certificate of Total Performance is the date on which Total Performance has been achieved.

D21. LIQUIDATED DAMAGES

- D21.1 If the Contractor fails to achieve Critical Stages, Substantial Performance or Total Performance in accordance with the Contract by the days fixed herein for same, the Contractor shall pay the City the following amounts per Working Day for each and every Working Day following the days fixed herein for same during which such failure continues:
- (a) Bannatyne Avenue – one thousand dollars (\$1,000);
 - (b) Academy Road – one thousand dollard dollars (\$1,000);
 - (c) Portage Avenue – one thousand dollars (\$1,000);
 - (d) Substantial Performance – one thousand dollars dollars (\$1,000);
 - (e) Total Performance – one thousand dollars (\$1,000).
- D21.2 The amounts specified for liquidated damages in D21.1 are based on a genuine pre-estimate of the City's losses in the event that the Contractor does not achieve critical stages, Substantial Performance or Total Performance by the days fixed herein for same.
- D21.3 The City may reduce any payment to the Contractor by the amount of any liquidated damages assessed.

CONTROL OF WORK

D22. JOB MEETINGS

- D22.1 Regular weekly job meetings will be held at the site .These meetings shall be attended by a minimum of one representative of the Contract Administrator and one representative of the Contractor. Each representative shall be a responsible person capable of expressing the position of the Contract Administrator and the Contractor respectively on any matter discussed at the meeting including the Work schedule and the need to make any revisions to the Work schedule. The progress of the Work will be reviewed at each of these meetings.
- D22.2 The Contract Administrator reserves the right to cancel any job meeting or call additional job meetings whenever he deems it necessary.

D23. PRIME CONTRACTOR – THE WORKPLACE SAFETY AND HEALTH ACT (MANITOBA)

- D23.1 Further to C6.24, the Contractor shall be the Prime Contractor and shall serve as, and have the duties of the Prime Contractor in accordance with The Workplace Safety and Health Act (Manitoba).

WARRANTY

D24. WARRANTY

- D24.1 Notwithstanding C13.2, the Contract Administrator may permit the warranty period for a portion or portions of the Work to begin prior to the date of Substantial Performance if:
- (a) a portion of the Work cannot be completed because of unseasonable weather or other conditions reasonably beyond the control of the Contractor but that portion does not prevent the balance of the Work from being put to its intended use.
- D24.1.1 In such case the date specified by the Contract Administrator for the warranty period to begin shall be substituted for the date specified in C13.2 for the warranty period to begin.

FORM H1: PERFORMANCE BOND
(See D10)

KNOW ALL MEN BY THESE PRESENTS THAT

_____ ,
(hereinafter called the "Principal"), and

_____ ,
(hereinafter called the "Surety"), are held and firmly bound unto **THE CITY OF WINNIPEG** (hereinafter called the "Obligee"), in the sum of

_____ dollars (\$ _____ . _____)

of lawful money of Canada to be paid to the Obligee, or its successors or assigns, for the payment of which sum the Principal and the Surety bind themselves, their heirs, executors, administrators, successors and assigns, jointly and severally, firmly by these presents.

WHEREAS the Principal has entered into a written contract with the Obligee for

BID OPPORTUNITY NO. 375-2011

2011 RENEWAL AND NEW CONSTRUCTION OF SIDEWALKS, INSTALLATION OF DETECTABLE WARNING SURFACE TILES AND ASSOCIATED WORKS

which is by reference made part hereof and is hereinafter referred to as the "Contract".

NOW THEREFORE the condition of the above obligation is such that if the Principal shall:

- (a) carry out and perform the Contract and every part thereof in the manner and within the times set forth in the Contract and in accordance with the terms and conditions specified in the Contract;
- (b) perform the Work in a good, proper, workmanlike manner;
- (c) make all the payments whether to the Obligee or to others as therein provided;
- (d) in every other respect comply with the conditions and perform the covenants contained in the Contract; and
- (e) indemnify and save harmless the Obligee against and from all loss, costs, damages, claims, and demands of every description as set forth in the Contract, and from all penalties, assessments, claims, actions for loss, damages or compensation whether arising under "The Workers Compensation Act", or any other Act or otherwise arising out of or in any way connected with the performance or non-performance of the Contract or any part thereof during the term of the Contract and the warranty period provided for therein;

THEN THIS OBLIGATION SHALL BE VOID, but otherwise shall remain in full force and effect. The Surety shall not, however, be liable for a greater sum than the sum specified above.

AND IT IS HEREBY DECLARED AND AGREED that the Surety shall be liable as Principal, and that nothing of any kind or matter whatsoever that will not discharge the Principal shall operate as a discharge or release of liability of the Surety, any law or usage relating to the liability of Sureties to the contrary notwithstanding.

IN WITNESS WHEREOF the Principal and Surety have signed and sealed this bond the

_____ day of _____, 20____ .

SIGNED AND SEALED
in the presence of:

(Witness as to Principal if no seal)

(Name of Principal)

Per: _____ (Seal)

Per: _____

(Name of Surety)

By: _____ (Seal)
(Attorney-in-Fact)

**FORM H2: IRREVOCABLE STANDBY LETTER OF CREDIT
(PERFORMANCE SECURITY)**
(See D10)

(Date)

The City of Winnipeg
Legal Services Department
185 King Street, 3rd Floor
Winnipeg MB R3B 1J1

RE: PERFORMANCE SECURITY – BID OPPORTUNITY NO. 375-2011

2011 RENEWAL AND NEW CONSTRUCTION OF SIDEWALKS, INSTALLATION OF
DETECTABLE WARNING SURFACE TILES AND ASSOCIATED WORKS

Pursuant to the request of and for the account of our customer,

(Name of Contractor)

(Address of Contractor)

WE HEREBY ESTABLISH in your favour our irrevocable Standby Letter of Credit for a sum not exceeding
in the aggregate

_____ Canadian dollars.

This Standby Letter of Credit may be drawn on by you at any time and from time to time upon written demand for payment made upon us by you. It is understood that we are obligated under this Standby Letter of Credit for the payment of monies only and we hereby agree that we shall honour your demand for payment without inquiring whether you have a right as between yourself and our customer to make such demand and without recognizing any claim of our customer or objection by the customer to payment by us.

The amount of this Standby Letter of Credit may be reduced from time to time only by amounts drawn upon it by you or by formal notice in writing given to us by you if you desire such reduction or are willing that it be made.

Partial drawings are permitted.

We engage with you that all demands for payment made within the terms and currency of this Standby Letter of Credit will be duly honoured if presented to us at:

(Address)

and we confirm and hereby undertake to ensure that all demands for payment will be duly honoured by us.

All demands for payment shall specifically state that they are drawn under this Standby Letter of Credit.

Subject to the condition hereinafter set forth, this Standby Letter of Credit will expire on

(Date)

It is a condition of this Standby Letter of Credit that it shall be deemed to be automatically extended from year to year without amendment from the present or any future expiry date, unless at least 30 days prior to the present or any future expiry date, we notify you in writing that we elect not to consider this Standby Letter of Credit to be renewable for any additional period.

This Standby Letter of Credit may not be revoked or amended without your prior written approval.

This credit is subject to the Uniform Customs and Practice for Documentary Credit (1993 Revision), International Chamber of Commerce Publication Number 500.

(Name of bank or financial institution)

Per: _____
(Authorized Signing Officer)

Per: _____
(Authorized Signing Officer)

PART E - SPECIFICATIONS

GENERAL

E1. APPLICABLE SPECIFICATIONS AND DRAWINGS

- E1.1 These Specifications shall apply to the Work.
- E1.2 *The City of Winnipeg Standard Construction Specifications* in its entirety, whether or not specifically listed on Form B: Prices, shall apply to the Work.
- E1.2.1 *The City of Winnipeg Standard Construction Specifications* is available on the Information Connection page at The City of Winnipeg, Corporate Finance, Materials Management Division website at <http://www.winnipeg.ca/matmgt/Spec/Default.stm>
- E1.2.2 The version in effect three (3) Business Days before the Submission Deadline shall apply.
- E1.2.3 Further to C2.4(d), Specifications included in the Bid Opportunity shall govern over *The City of Winnipeg Standard Construction Specifications*.
- E1.3 The following are applicable to the Work:

<u>Drawing No.</u>	<u>Drawing Name/Title</u>	<u>Drawing (Original) Sheet Size</u>
	Cover Sheet	A1
SE-11-22	Academy Road, South Side, Stafford Street to Wellington Crescent	A1
SE-11-23	Academy Road, South Side, Stafford Street to Wellington Crescent	A1
SE-11-24	Bannatyne Avenue, Main St to Sta 2 + 50, Sidewalk Renewal	A1
SE-11-25	Bannatyne Avenue, Sta 2 + 50 to Sta 4 + 00, Sidewalk Renewal	A1
SE-11-26	Bannatyne Avenue, Sta 4 + 00 to Waterfront Drive, Sidewalk Renewal	A1
SE-11-27	Bannatyne Avenue, Main Street to Waterfront Drive, Drawing Details	A1

E2. PROTECTION OF EXISTING TREES

- E2.1 The Contractor shall take the following precautionary steps to prevent damage from construction activities to existing boulevard trees within the limits of the construction area:
- The Contractor shall not stockpile materials and soil or park vehicles and equipment on boulevards within 2 metres of trees.
 - Trees identified to be at risk by the Contract Administrator are to be strapped with 25 x 100 x 2400mm wood planks, or suitably protected as approved by the Contract Administrator.
 - Excavation shall be performed in a manner that minimizes damage to the existing root systems. Where possible, excavation shall be carried out such that the edge of the excavation shall be a minimum of 1.5 times the diameter (measured in inches), with the outcome read in feet, from the closest edge of the trunk. Where roots must be cut to facilitate excavation, they shall be pruned neatly at the face of excavation.
 - Operation of equipment within the dripline of the trees shall be kept to the minimum required to perform the work required. Equipment shall not be parked, repaired, refuelled; construction materials shall not be stored, and earth materials shall not be stockpiled within the driplines of trees. The dripline of a tree shall be considered to be the ground surface

directly beneath the tips of its outermost branches. The Contractor shall ensure that the operations do not cause flooding or sediment deposition on areas where trees are located.

- (e) Work on-site shall be carried out in such a manner so as to minimize damage to existing tree branches. Where damage to branches does occur, they shall be neatly pruned.

E2.2 All damage to existing trees caused by the Contractor's activities shall be repaired to the requirements and satisfaction of the Contract Administrator and the City Forester or his designate.

E2.3 No separate measurement or payment will be made for the protection of trees.

E2.4 Except as required in clause E2.1(c) and E2.1(e), Elm trees shall not be pruned at any time between April 1 and July 31.

E3. TRAFFIC CONTROL

E3.1 Further to clauses 3.6 and 3.7 of CW 1130:

- (a) Where directed, the Contractor shall construct and maintain temporary asphalt ramps to alleviate vertical pavement obstructions such as manholes and planing drop-offs to the satisfaction of the Contract Administrator. Payment shall be in accordance with CW3410.
- (b) In accordance with the Manual of Temporary Traffic Control in Work Areas on City Streets, the Contractor ("Agency" in the manual) shall make arrangements with the Traffic Services Branch of the City of Winnipeg to place all temporary regulatory signs. The Contractor shall bear all costs associated with the placement of temporary traffic control devices by the Traffic Services Branch of the City of Winnipeg in connection with the works undertaken by the Contractor.

E4. TRAFFIC MANAGEMENT

E4.1 Further to clause 3.7 of CW 1130:

E4.1.1 Should the Contractor be unable to maintain pedestrian or vehicular access to a residence or business, he shall review the planned disruption with the business or residence and the Contract Administrator, and take reasonable measures to minimize the impact. The Contractor shall provide a minimum of 24 hours notification to the affected residence or business and the Contract Administrator, prior to disruption of access.

E4.1.2 Pedestrian and ambulance/emergency vehicle access must be maintained at all times.

E5. WATER OBTAINED FROM THE CITY

E5.1 Further to clause 3.7 of CW 1120, the Contractor shall pay for all costs, including sewer charges, associated with obtaining water from the City in accordance with the Waterworks and Sewer By-laws.

E6. SURFACE RESTORATIONS

E6.1 Further to clause 3.3 of CW 1130, when Total Performance is not achieved in the year the Contract is commenced, the Contractor shall temporarily repair any Work commenced and not completed to the satisfaction of the Contract Administrator. The Contractor shall maintain the temporary repairs in a safe condition as determined by the Contract Administrator until permanent repairs are completed. The Contractor shall bear all costs associated with temporary repairs and their maintenance.

E7. RECYCLED CONCRETE BASE COURSE MATERIAL

DESCRIPTION

E7.1 General

E7.1.1 Further to CW 3110, this specification covers recycled concrete as base course material.

E7.2 Definitions

E7.2.1 Deleterious material – are materials such as vegetation, organic material, wood, glass, plastic, metal, reinforcing steel, building rubble, brick, salvaged asphalt materials, clay, shale, and friable particles.

E7.3 Referenced Standard Construction Specifications

- (a) CW 3110 – Sub-Grade. Sub-Base and Base Course Construction.
- (b) CW 3235 – Renewal of Existing Miscellaneous Concrete Slabs.
- (c) CW 3325 – Portland Cement Concrete Sidewalk.

MATERIALS

E7.4 Recycled Concrete Base Course Material

E7.4.1 Recycled concrete base course material must meet the approval of the Contract Administrator.

E7.4.2 Recycled concrete base course material will consist of sound durable particles produced by crushing, screening, and grading of recovered concrete materials, free from soft material that would disintegrate through decay or weathering.

E7.4.3 Recycled concrete base course material will be well graded and conform to the following grading requirements:

Recycled Concrete Base Course Material Grading Requirements

CANADIAN METRIC SIEVE SIZE	PERCENT OF TOTAL DRY WEIGHT PASSING EACH SIEVE
20 000	100%
5 000	40% - 70%
2 500	25% - 60%
315	8% - 25%
80	6% - 17%

E7.4.4 Recycled concrete base course material when subjected to the abrasion test will have a loss of not more than 35% when tested in accordance with grading B of ASTM C131, Test for Resistance to Degradation of Small-Size Coarse Aggregate by Abrasion and Impact in the Los Angeles Machine.

E7.4.5 The amount of deleterious material will be limited to a maximum of two percent of the total dry weight.

CONSTRUCTION METHODS

E7.5 Placement of Recycled Concrete Base Course Material

E7.5.1 Place and compact recycled concrete base course material as a levelling course to a maximum thickness of 50 millimetres

E7.5.2 Spread materials uniformly to avoid segregation free of pockets of fine and coarse material.

- E7.5.3 Place and compact recycled concrete base course material to a minimum 75 millimetres in thickness for pavement, approaches and asphalt pathways to a minimum of 100% Standard Proctor Density for the full width of the excavation unless otherwise shown on the Drawings or as directed by the Contract Administrator.
- E7.5.4 Maintain the finished material until the hard surfacing is placed.

MEASUREMENT AND PAYMENT

- E7.6 Recycled Concrete Base Course Material
- E7.6.1 The supplying, placing and compaction of recycled concrete base course material will be measured on a volume basis and paid for at the Contract Unit Price per cubic metre for the "Supplying and Placing Base Course Material" as specified in accordance with CW 3110.
- E7.6.2 No measurement or payment will be made for material placed as a levelling course under miscellaneous concrete slabs and sidewalks where the costs are included in accordance with CW 3235 and CW 3325.
- E7.6.3 No measurement or payment will be made for materials rejected by the Contract Administrator.

E8. SALT TOLERANT GRASS SEEDING

DESCRIPTION

- E8.1 Further to CW 3520 and CW3540, this specification shall cover sub-grade preparation and the supply and placement of Salt Tolerant Grass Seed.

MATERIALS

- E8.2 Salt Tolerant Grass Seed
- E8.2.1 Salt Tolerant Grass Seed for regional and collector boulevards, medians and interchange areas shall be a mixture composed of:
- (a) Seventy percent (70%) Fults or Nuttals Alkaligrass (*Puccinellia* spp.), twenty percent (20%) Audubon or Aberdeen Creeping Red Fescue and ten percent (10%) Perennial Ryegrass.

EQUIPMENT

- E8.3 Scarification equipment shall be suitable for the area being scarified, shall be capable of scarifying the sub-grade to the specified depth and shall be accepted by the Contract Administrator. For confined areas a toothed bucket may be acceptable. For larger areas tilling equipment may be required.

CONSTRUCTION METHODS

- E8.4 Preparation of Existing Grade
- E8.4.1 Prior to placing topsoil, in areas to be seeded greater in width than 600mm, prepare the existing sub-grade by scarifying to a minimum depth of 75mm and to a maximum depth of 100mm to the satisfaction of the Contract Administrator.
- E8.4.2 Scarification shall consist of breaking up and loosening the sub-grade. No scarification shall occur within the edge of a tree canopy (or drip line).
- E8.5 Salt Tolerant Grass Seeding
- E8.5.1 Salt Tolerant Grass Seed shall be sown at a rate of 2.2 kilograms per 100 square meters.

MEASUREMENT AND PAYMENT

- E8.6 Supply, placement and maintenance of Salt Tolerant Grass Seed will be paid for at the Contract Unit Price per square metre for "Salt Tolerant Grass Seeding", measured as specified herein, which price shall be payment in full for supplying all materials and for completing all operations herein described and all other items incidental to the work included in this Specification. Payment for Salt Tolerant Grass Seeding shall be in accordance with the following:
- (a) Sixty five (65%) percent of quantity following supply and placement.
 - (b) Remaining thirty five (35%) percent of quantity following termination of the Maintenance Period.

E9. SUPPLY AND INSTALL DETECTABLE WARNING SURFACE TILES

DESCRIPTION

- E9.1 This specification covers the supply and installation of detectable warning surface tiles in sidewalk ramps and multi-use path ramps.

SPECIFICATIONS AND DRAWINGS

- E9.2 Referenced Standard Construction Specifications and Standard Details
- (a) CW 3235 - Renewal of Existing Miscellaneous Concrete Slabs
 - (b) CW 3240 - Renewal of Existing Curbs
 - (c) CW 3310 - Portland Cement Concrete Pavement Works
 - (d) CW 3325 - Portland Cement Concrete Sidewalk
 - (e) SD-229C - Curb Ramp for Concrete Pavement
 - (f) SD-229D - Curb Ramp for Asphalt Overlay
- E9.3 Attached; SDE Drawings and Installation Manual
- (a) SDE-229A - Curb Ramp Layout for Intersections
 - (b) SDE-229AA - Detectable Warning Surface Tile in Curb Ramps for Intersections, Layout Option 1
 - (c) SDE-229AC – 300x300 Detectable Warning Surface Tile, Layout Option 3
 - (d) SDE-229AD – 300x300 Detectable Warning Surface Tile, Layout Option 3 DETAIL
 - (e) SDE-229AE – Curb Ramp for Pedestrian Corridor with a Traffic Control Device
 - (f) SDE-229AF – Detectable Warning Surface Tile Orientation for Offset Intersections
 - (g) SDE-229BB – Detectable Warning Surface Tile in Curb Ramps for Medians
 - (h) SDE-229E - Curb Ramp Depressed Curb
 - (i) Installation Instructions for Cast in Place Inline Dome Detectable/Tactile Warning Surface Tile.

MATERIALS

- E9.4 Acceptable Detectable Warning Surface Tile product is:
- (a) 610 x 1220mm (2'x 4') Armor-Tile Cast in Place (Federal Yellow).
 - (b) 300 x 300mm (1'x1') Armor-Tile cast in Place (Federal Yellow).

ADA Solutions Inc. tiles are available from:
Brock White Canada
879 Keewatin Street
Winnipeg, Manitoba

Attention: Bernie Giesbrecht
Ph. 479-8089

Armor Tile Tactile Systems tiles are available from:
Alsip's Building Products
1 Cole Avenue
Winnipeg, Manitoba

Attention: Jason Alsip
Ph. 204-667-3330

- E9.4.1 Detectable warning surface tiles shall be Federal Yellow (USA); or Safety Yellow (Canada).
- E9.4.2 Detectable warning surface tiles shall be cast in place type.
- E9.4.3 Truncated domes on detectable warning surface tiles shall be in accordance with ADA Accessibility Guidelines (ADAAG).

CONSTRUCTION METHODS

- E9.5 Selection of Layout Options
 - E9.5.1 Select the appropriate design layout for detectable warning surface tiles according to the following prioritized order:
 - E9.5.2 Layout Option One – Install detectable warning surface tiles in accordance with SDE-229A and SDE-229AA.
 - E9.5.3 If two 610 x 1220mm tiles would physically overlap each other, or would be within 150mm of each other, or if one tile would lie within the circulation path towards the other tile, then install the detectable warning surface tiles according to the following order, Layout Option Two(2) or Three(3).
 - E9.5.4 Layout Option Two – Separate the tiles by moving either one or both tiles along the curb line in opposite directions, in accordance with this Specification, and keeping the ramp and pedestrian road crossing as perpendicular to the road as is possible, as directed by the Contact Administrator.
 - E9.5.5 Layout Option Three – Install detectable warning surface tiles in accordance with SDE-229AC and SDE-229AD.
- E9.6 General
 - E9.6.1 Construct curb ramps, sidewalk ramps and multi-use paths in accordance with the referenced Standard Construction Specifications, Standard Details, and SDE drawings.
 - E9.6.2 Detectable warning surface tile shall not be placed at private approaches or alleys.
 - E9.6.3 All curb ramps opposite each other shall have the same width.
 - E9.6.4 Construct the lip of the depressed curb in accordance with SDE – 229E.
 - E9.6.5 Construct ramp slopes in accordance with SD-229C and SD-229D. Use a ramp slope with preference for a slope as close to 5% maximum as possible.
 - E9.6.6 Construct flare and curb taper slopes according to the following:
 - (a) If the curb taper is within a grassed area, construct the curb taper 900mm in length.
 - (b) When the flare and curb taper are in a full width sidewalk and the sidewalk area at the top of the ramp is <1500mm in width, construct the flare and curb taper at 5% slope to allow safe passage for wheelchairs in this area.
 - (c) When the flare and curb taper are in a full width sidewalk and the sidewalk area at the top of the ramp is ≥ 1500mm in width, construct the flare and curb taper at 10% slope.

- E9.6.7 Install the detectable warning surface tile in accordance with the attached Installation Instructions. Drill additional 6mm air vent holes in the ribs under the tile as required, and use vibration to help seat the tile, to facilitate the installation process.
- E9.6.8 Trim the corner of the tile at curb radii in accordance with SDE-229AA and SDE-229AD.
- E9.6.9 Install the detectable warning surface tiles as shown on the referenced drawings or as directed by the Contract Administrator.
- E9.6.10 Orient the detectable warning surface tiles perpendicular to the crossing direction.
- E9.6.11 Locate gratings, access covers and other appurtenances outside of the sidewalk ramps, depressed curbs, rest areas, and gutters in front of the depressed curbs, as directed by the Contact Administrator.
- E9.7 Medians and Refuge Islands
- E9.7.1 Where the distance from back of curb to back of curb is 1.32m or greater, install one detectable warning surface tile 50mm from the back of each curb.
- E9.7.2 Where the distance from back of curb to back of curb is less than 1.32m, place the tiles 50mm from the back of curb and cut the tile(s) to fill the remaining area between the curbs.
- E9.8 Multi-Use Paths
- E9.8.1 2.0m Wide Depressed Curb for Multi-use Paths
- Construct a curb ramp with a 2.0m depressed curb at high volume collector and regional street intersections in accordance with SDE-229E, in accordance with Public Works Department guidelines and as directed by the Contract Administrator.
 - Construct the concrete ramp 2.0m wide and a minimum of 1.50m deep from back of curb.
 - Construct the curb ramp in accordance with SD-229C and SD229D.
 - Install one (1) 610mm x 1220mm tile centered to the 2.0m wide depressed curb. The part of the tile nearest the curb must be 50mm from the back of curb similar to tile placement in SDE-229AA.
- E9.8.2 3.5m Wide Depressed Curb for Multi-use Paths
- Construct a curb ramp with a 3.5m depressed curb at low volume collector and residential street intersections in accordance with SDE-229E, in accordance with Public Works Department guidelines and as directed by the Contact Administrator.
 - Construct the concrete ramp 3.5m wide and a minimum of 1.50m deep from back of curb.
 - Construct the curb ramp in accordance with SD-229C and SD229D.
 - Install two (2) tiles in each concrete ramp, one (1) on each side for each direction. Place the short edge of each tile 150mm from the edge of the concrete ramp, with both tiles in line with each other transversely across the concrete ramp. The tile(s) nearest the curb must be 50mm from back of curb similar to tile placement in SDE-229AA.
 - Saw cut the middle of the concrete slab, perpendicular to the curb and to a depth of D/4. Cut additional sawcuts as directed by the Contract Administrator.

MEASUREMENT AND PAYMENT

- E9.9 610 x 1220mm Detectable Warning Surface Tiles
- E9.9.1 Supply and installation of detectable warning surface tiles will be measured on a unit basis and paid for at the Contract Unit Price for "610 x 1220mm Detectable Warning Surface Tiles". The number of units to be paid for will be the total number of full or trimmed tiles

supplied and installed in accordance with this specification, accepted and measured by the Contract Administrator.

E9.10 300 x 300mm Detectable Warning Surface Tiles

E9.10.1 Supply and installation of detectable warning surface tiles will be measured on a unit basis and paid for at the Contract Unit Price for "300 x 300mm Detectable Warning Surface Tiles". The number of units to be paid for will be the total number of full or trimmed tiles supplied and installed in accordance with this specification, accepted and measured by the Contract Administrator.

E9.10.2 The area under the detectable warning surface tile is part of the concrete sidewalk ramp and will be paid in accordance with CW 3235 or CW 3325.

E9.10.3 The concrete sidewalk ramp and the concrete ramp for multi-use paths will be paid as 100mm sidewalk in accordance with CW 3235 or CW 3325.

E9.10.4 Curb ramp will be paid in accordance with CW 3240 or CW 3310.

DRAWINGS AND INSTALLATION MANUAL

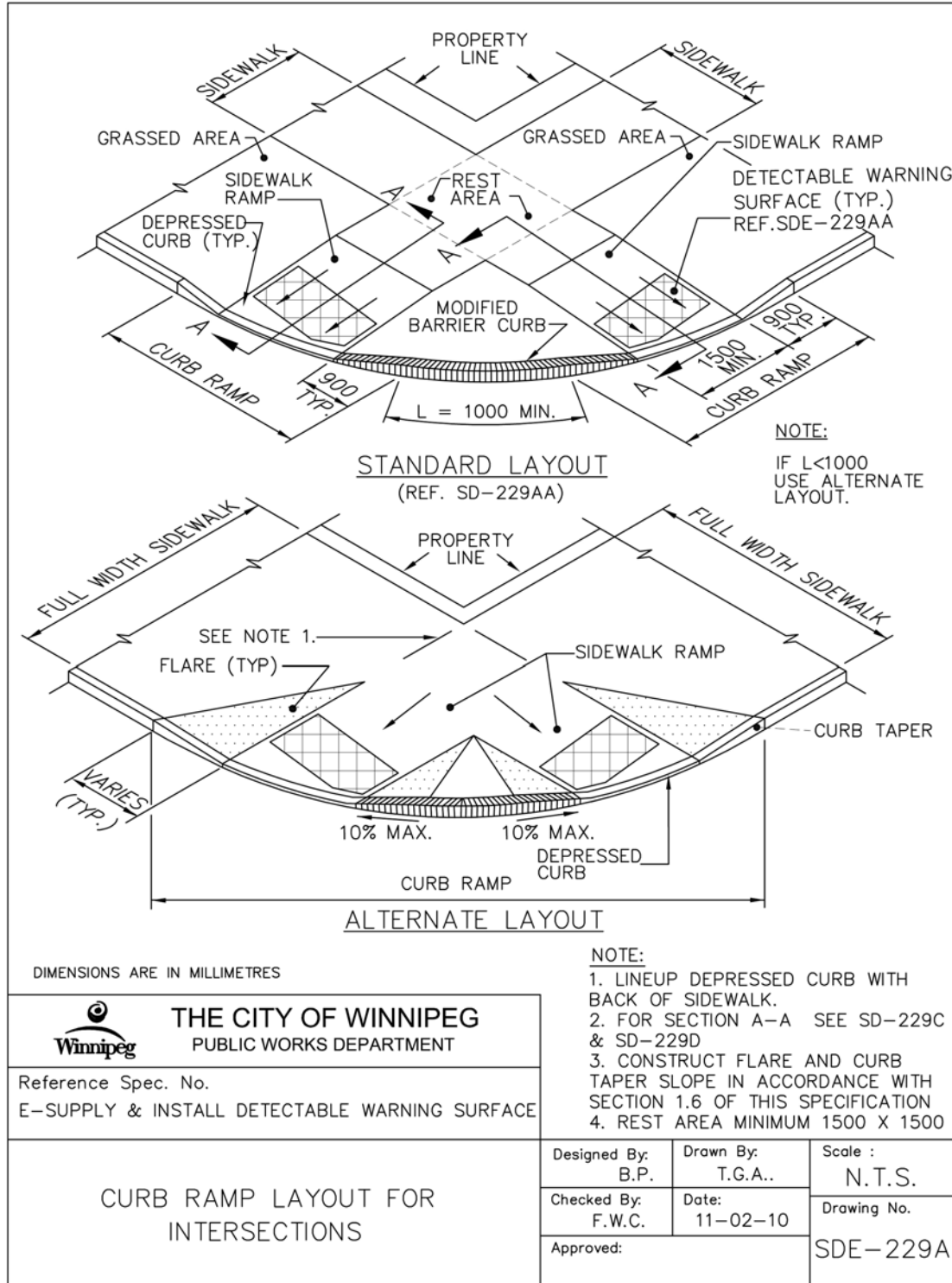

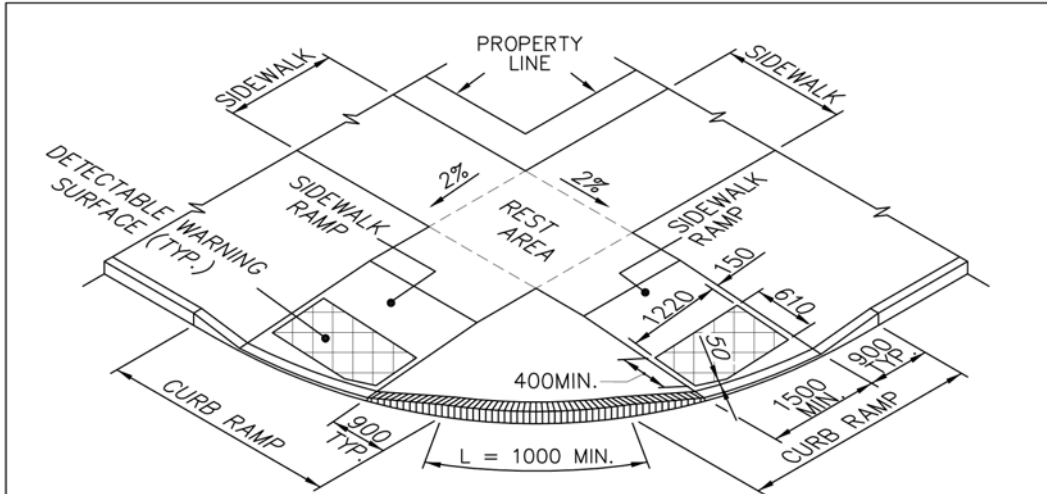

STANDARD LAYOUT

(REF. SD-229A)

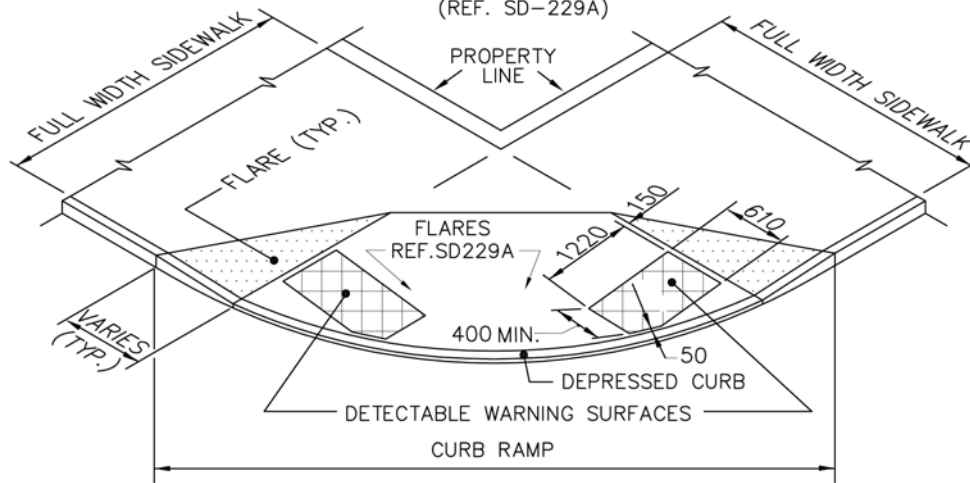

ALTERNATE LAYOUT

(REF. SD-229A)



THE CITY OF WINNIPEG
 PUBLIC WORKS DEPARTMENT

Reference Spec. No.
 CW 3235, CW 3310, CW 3325
 E-SUPPLY & INSTALL DETECTABLE WARNING SURFACE

DIMENSIONS ARE IN MILLIMETRES

DETECTABLE WARNING SURFACE TILE
 SURFACE IN CURB RAMPS FOR
 INTERSECTIONS. **LAYOUT OPTION 1**

Designed By: B.P.	Drawn By: T.G.A.	Scale : N.T.S.
Checked By: F.W.C.	Date: 11-02-10	Drawing No.
Approved:	SDE-229AA	

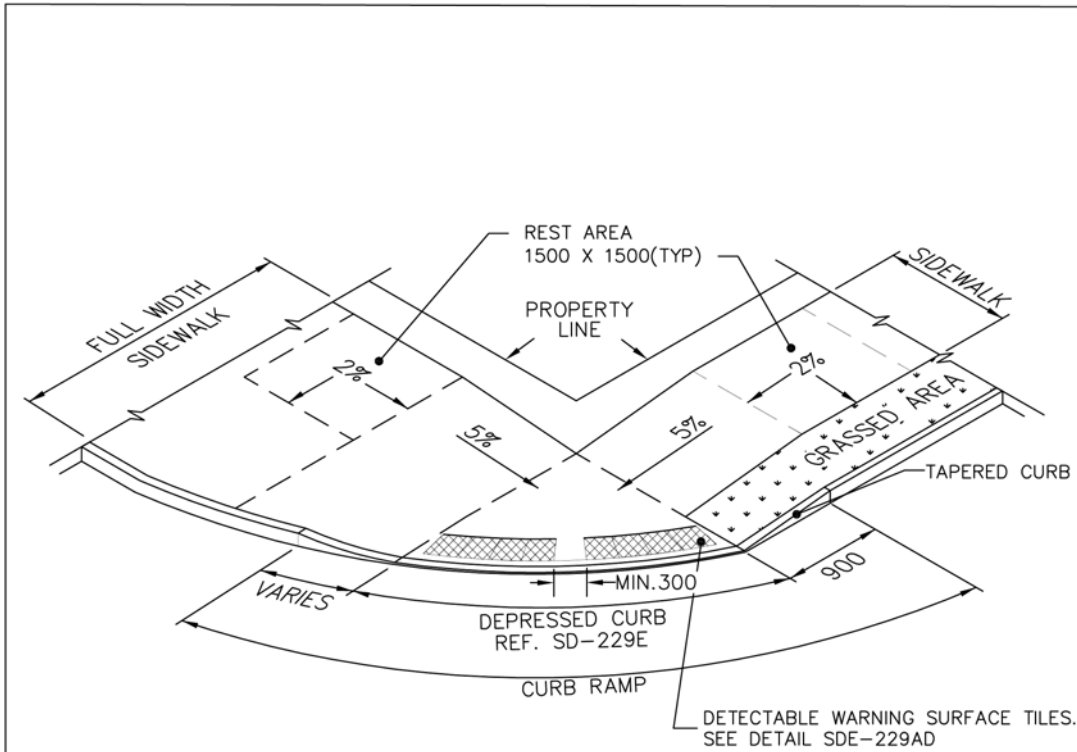

NOTES:
 1. PLACE 300x300 DETECTABLE WARNING SURFACE TILES IN ACCORDANCE WITH "SELECTION OF LAYOUT OPTIONS" IN THIS SPECIFICATION.

 THE CITY OF WINNIPEG PUBLIC WORKS DEPARTMENT	DIMENSIONS ARE IN MILLIMETRES		
	Reference Spec. No. E-SUPPLY AND INSTALL DETECTABLE WARNING SURFACE TILES	Designed By: B.P.	Drawn By: R.R.
300 X 300 mm DETECTABLE WARNING SURFACE TILE LAYOUT OPTION 3	Checked By:	Date: 11-02-10	Drawing No.
	Approved:	SDE-229AC	

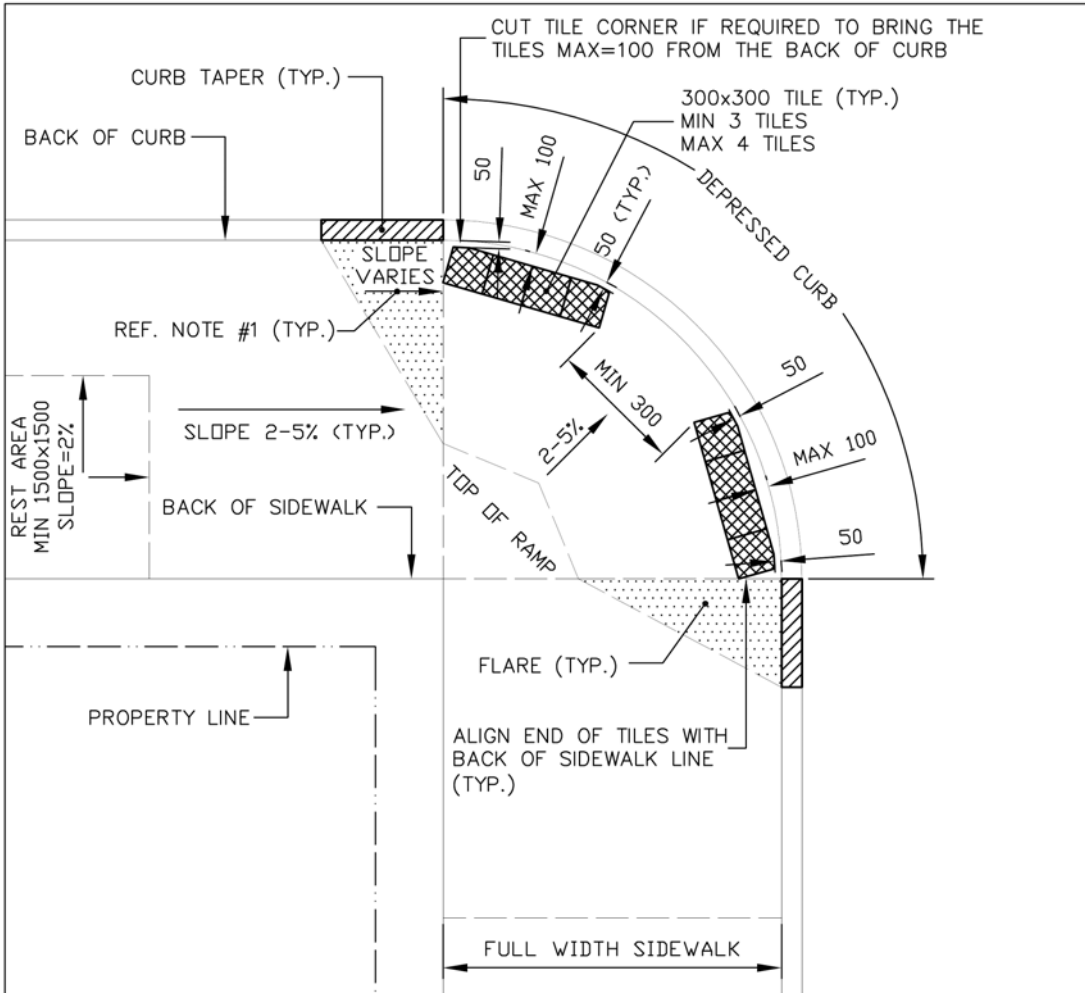

NOTES:
 1. WHEN THE SIDEWALK AREA AT THE TOP OF THE RAMP IS $\geq 1500\text{mm}$ OR $< 1500\text{mm}$ IN WIDTH, CONSTRUCT THE SLOPE OF THE CURB RAMP AND THE CURB TAPER IN ACCORDANCE WITH SECTION 1.6 OF THIS SPECIFICATION.

 THE CITY OF WINNIPEG
 PUBLIC WORKS DEPARTMENT
 ENGINEERING DIVISION
 TECHNOLOGY SERVICES BRANCH
 106 - 1155 PACIFIC AVE

Reference Spec. No.
 E-SUPPLY AND INSTALL DETECTABLE WARNING SURFACE TILES

DIMENSIONS ARE IN MILLIMETRES

300x300mm DETECTABLE WARNING SURFACE TILE LAYOUT OPTION 3 DETAIL

Designed By: B.P.	Drawn By: R.R.	Scale: N.T.S.
Checked By:	Date: 11-02-10	Drawing No.
Approved:	SDE-229AD	

Scale:
N.T.S.
 Drawing No.
 SDE-229AD

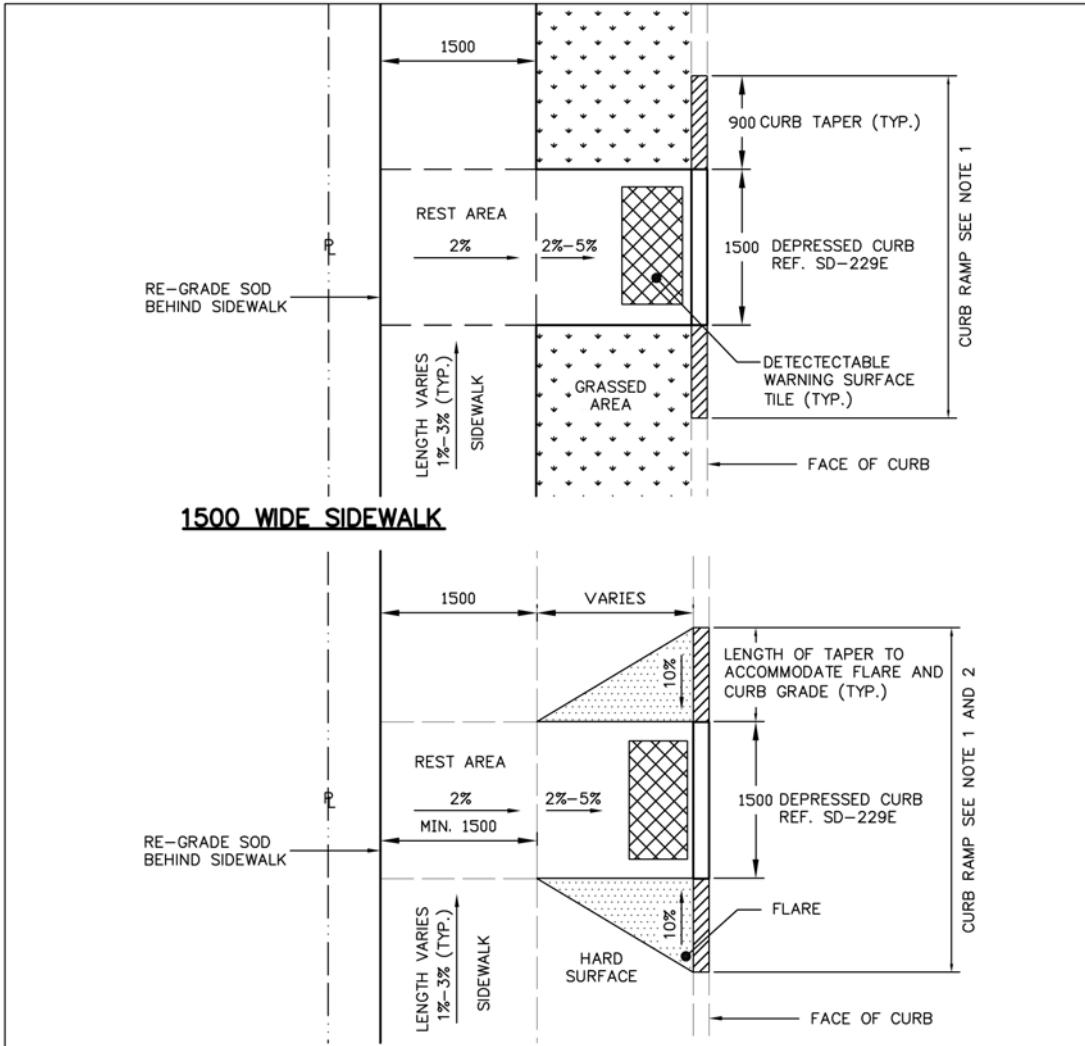

1500 WIDE SIDEWALK

FULL WIDTH SIDEWALK

- NOTES:**
1. FULL DEPTH SAWCUT REQUIRED THROUGH THE STREET SLAB ALONG THE CURB RAMP. REF. SD-229C, SD-229D
 2. IF THE LENGTH OF THE SIDEWALK RAMP DOES NOT LEAVE SPACE FOR THE REST AREA, CONSTRUCT THE FLARE AND CURB TAPER IN ACCORDANCE WITH SECTION 1.6 OF THIS SPECIFICATION

DIMENSIONS ARE IN MILLIMETRES

Winnipeg

THE CITY OF WINNIPEG
 PUBLIC WORKS DEPARTMENT
 ENGINEERING DIVISION
 TECHNOLOGY SERVICES BRANCH
 106 - 1155 PACIFIC AVE

Reference Spec. No.
 E-SUPPLY AND INSTALL DETECTABLE WARNING SURFACE TILES

CURB RAMP FOR PEDESTRIAN CORRIDOR WITH A TRAFFIC CONTROL DEVICE

Designed By: B.P.	Drawn By: R.R.	Scale: N.T.S.
Checked By:	Date: 11-02-10	Drawing No.
Approved:	SDE-229AE	

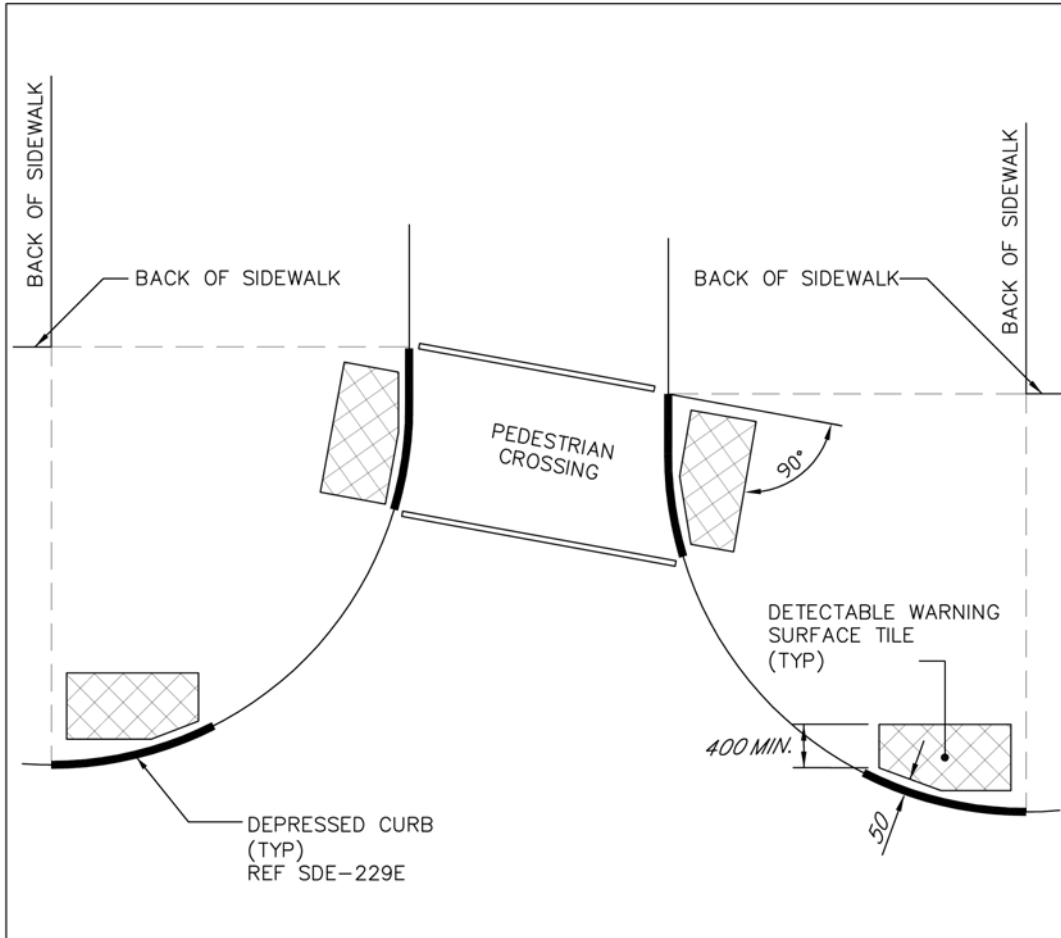

NOTES:

1. LOCATE END OF DEPRESSED CURB IN LINE WITH PROJECTED BACK OF SIDEWALK.
2. CONSTRUCT FLARES IN ACCORDANCE WITH SDE-229A

 **THE CITY OF WINNIPEG**
 PUBLIC WORKS DEPARTMENT

Reference Spec. No.
 CW 3235, CW 3310, CW 3325
 E-SUPPLY & INSTALL DETECTABLE WARNING
 SURFACE TILES

DIMENSIONS ARE IN MILLIMETRES

DETECTABLE WARNING SURFACE TILE
 ORIENTATION FOR
 OFFSET INTERSECTIONS

Designed By: B.P.	Drawn By: T.G.A.	Scale : N.T.S.
Checked By: F.W.C.	Date: 11-02-10	Drawing No.
Approved:	SDE-229AF	

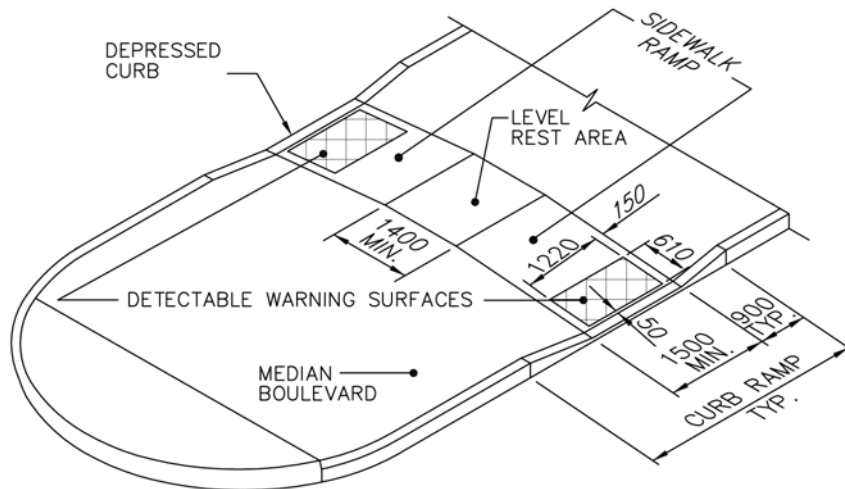

MEDIAN SIDEWALK CROSSING
 (REF. SD-229B)

NOTE:

1. FOR NARROW MEDIANS AND REFUGE ISLANDS < 1.32m IN WIDTH, PLACE DETECTABLE WARNING SURFACE FULL WIDTH, MAINTAINING 50mm SPACING FROM BACK OF CURB.

 THE CITY OF WINNIPEG PUBLIC WORKS DEPARTMENT			
Reference Spec. No. CW 3235, CW 3310, CW 3325 E-SUPPLY & INSTALL DETECTABLE WARNING SURFACE		DIMENSIONS ARE IN MILLIMETRES	
DETECTABLE WARNING SURFACE TILE IN CURB RAMPS FOR MEDIANS		Designed By: B.P.	Drawn By: T.G.A.
		Checked By: F.W.C.	Date: 11-02-10
		Approved:	
		Scale : N.T.S.	Drawing No. SDE-229BB

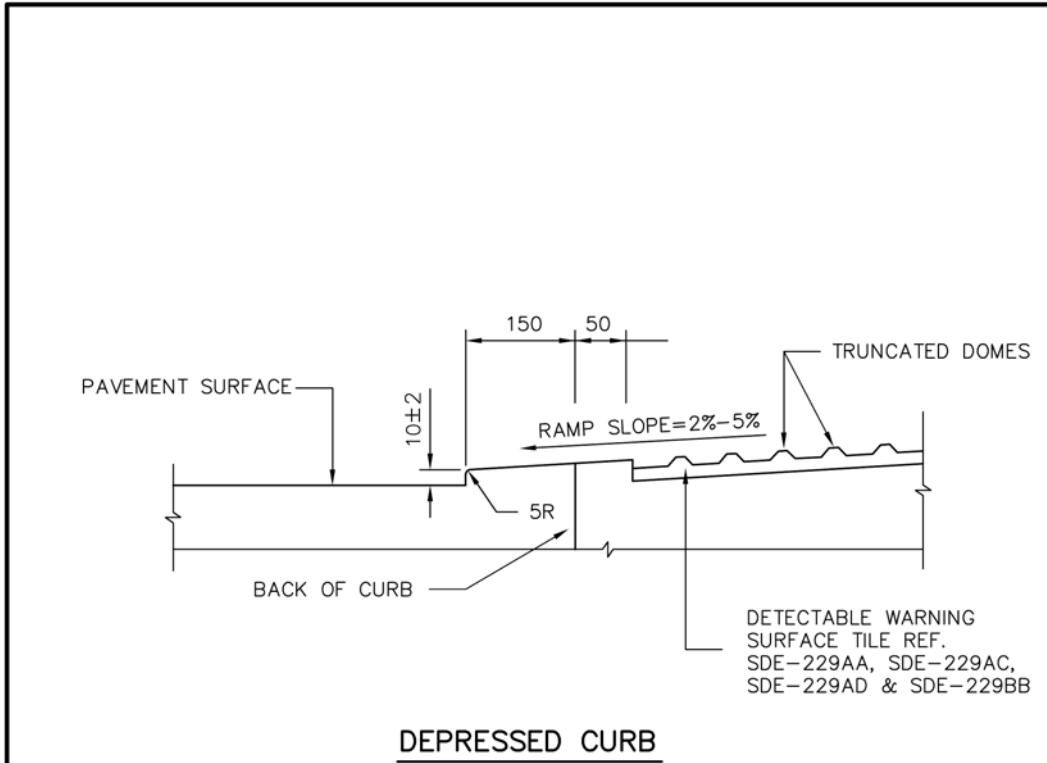

NOTES:

- 1) SIDEWALK RAMP SURFACE SHALL BE GIVEN A PARALLEL TEXTURED BROOM FINISH.
- 2) INSTALL DETECTABLE WARNING SURFACE SO THAT THE TOP OF THE TRUNCATED DOMES ARE FLUSH WITH THE SURFACE FO THE ADJACENT SIDEWALK.

THE CITY OF WINNIPEG PUBLIC WORKS DEPARTMENT	DIMENSIONS ARE IN MILLIMETRES		
Reference Spec. No. CW 3235, CW 3310, CW 3325 E-SUPPLY & INSTALL DETECTABLE WARNING SURFACE	Designed By: B.P.	Drawn By: T.G.A.	Scale : N.T.S.
CURB RAMP DEPRESSED CURB	Checked By: F.W.C.	Date: 11-02-10	Drawing No.
	Approved:		SDE-229E

INSTALLATION INSTRUCTIONS FOR CAST IN PLACE INLINE DOME DETECTABLE/TACTILE WARNING SURFACE TILE

- (a) During Cast In Place Detectable/Tactile Warning Surface Tile installation procedures, ensure adequate safety guidelines are in place and that they are in accordance with the applicable industry and government standards.
- (b) The specifications of the structural embedment flange system and related materials shall be in strict accordance with the contract documents and the guidelines set by their respective manufacturers. Do not set Cast In Place tiles in asphaltic concrete.
- (c) The physical characteristics of the concrete shall be consistent with the contract specifications. An overly wet mix will cause the tile to float. Under these conditions, suitable weights such as 2 concrete blocks or sandbags (12 kg) shall be placed on each tile.
- (d) Prior to placement of the Cast In Place Detectable/Tactile Warning Surface Tile system, the contract drawings shall be reviewed.
- (e) The concrete pouring and finishing operations require typical mason's tools, however, a 4' long level with electronic slope readout, 12 kg weights, and a large non-marring rubber mallet are specific to the installation of the Cast In Place Detectable/Tactile Warning Surface Tile system. A vibrating mechanism can be employed, if desired. The vibrating unit should be fixed to a soft base such as wood, at least 0.3m square.
- (f) The factory-installed plastic sheeting must remain in place during the entire installation process to prevent the splashing of concrete onto the finished surface of the tile.
- (g) When preparing to set the tile, it is important that NO concrete be removed in the area to accept the tile. It is imperative that the installation technique eliminates any air voids under the tile. Holes in the tile perimeter allow air to escape during the installation process. Concrete will flow through the large holes in each embedment flange on the underside of the tile. This will lock the tile solidly into the cured concrete.
- (h) The concrete shall be poured and finished true and smooth to the required dimensions and slope prior to the tile placement. The tile shall be placed in accordance with the contract drawings.
- (i) The Cast In Place Detectable/Tactile Warning Surface Tiles shall be tamped (or vibrated) into the fresh concrete to ensure that the surface of the truncated domes are flush to the adjacent concrete surface. Embedment of the tile so the top of the truncated domes are flush with the adjacent concrete will reduce the possibility of damage due to snow clearing operations. The embedment process should not be accomplished by stepping on the tile as this may cause uneven setting which can result in air voids under the tile surface.
- (j) While concrete is workable, a 3/8" radius edging tool shall be used to create a finished edge of concrete, a steel trowel shall then be used to finish the concrete around the tile's perimeter.
- (k) During and after the tile installation and the concrete curing stage, it is imperative that there is no walking, leaning or external force placed on the tile that may rock the tile causing a void between the underside of tile and concrete.
- (l) Following tile placement, review installation tolerances to contract drawings and adjust tile before the concrete sets. Two suitable weights of 12kg each shall be placed on each tile as necessary to ensure solid contact of the underside of tile to concrete.
- (m) Following the concrete curing stage, protective plastic wrap is to be removed from the tile surface by cutting the plastic with a sharp knife, tight to the concrete/tile interface. If concrete bled under the plastic, a soft brass wire brush will clean the residue without damage to the tile surface.
- (n) If required, individual tiles can be bolted together using 1/4 inch or equivalent hardware. This can help to ensure that adjacent tiles are flush to each other during the installation process. Tape or caulking can be placed on the underside of the bolted butt joint to ensure that

concrete does not rise up between the tiles during installation. Any protective plastic wrap which was peeled back to facilitate bolting or cutting, should be replaced and taped to ensure that the tile surface remains free of concrete during the installation process.

- (o) Tiles can be cut using a continuous rim diamond blade in a circular saw or mini-grinder. Use of a straightedge to guide the cut is advisable where appropriate.

E10. REINFORCED CONCRETE TREE WELL CURB

DESCRIPTION

- E10.1 This Specification shall cover the operations relating to the construction of reinforced concrete tree well curb. The Work to be done under this Specification shall include the furnishings of all superintendence, overhead, labour, materials, equipment, tools, supplies, and all other things necessary for and incidental to the satisfactory performance and completion of all Work specified.

MATERIALS

- E10.2 Concrete Mix
 - (i) Cement: Type 50 Sulphate resistant
 - (ii) Maximum Coarse Aggregate: 20 mm
 - (iii) Minimum Compressive Strength at 28 days: 35 Mpa
 - (iv) Minimum Cement Content: 310 Kg/cu.m
 - (v) Maximum Water/Cement Ratio: 0.45
 - (vi) Class of Exposure: C-2
 - (vii) Maximum Slump: 80 mm + or - 20 mm
 - (viii) Air Content: 5 – 8%
 - (ix) Fly ash Content: Maximum 15% of Cementitious Material

- E10.3 10M Longitudinal Deformed Bars

CONSTRUCTION METHODS

- E10.4 Construction of Reinforced Concrete Tree Well Curb
 - E10.4.1 The Contractor must ensure that the extent of all buried utilities and services are located and if necessary, protected and exposed prior to any excavation.
 - E10.4.2 Excavate to accommodate for forms and granular base.
 - E10.4.3 Dispose of material in accordance with section 3.4 of CW 1130.
 - E10.4.4 Compact granular base in accordance with specification CW 3110
 - E10.4.5 Place 10M Longitudinal Deformed Bars for reinforcement in accordance with section 9.2 of CW 3310 and as specified on the Contract drawings.
 - E10.4.6 Place Concrete for Tree Well Curb with the intention of leaving forms in place to prevent granular base undermining during future tree well excavation activities.

MEASUREMENT AND PAYMENT

- E10.5 Construction of Reinforced Concrete Tree Well Curb
 - E10.5.1 Construction of Reinforced Concrete Tree Well Curb will be measured on a length basis and paid for at the Contract Unit Price per metre for "Construction of Reinforced Concrete Tree Well Curb". The length to be paid for will be the total number of metres of Reinforced Concrete Tree Well Curb constructed in accordance with this Specification, accepted and measured by the Contract Administrator.

E11. MONOLITHIC CURB AND 100MM CONCRETE SIDEWALK WITH BLOCK-OUTS FOR PAVERS

GENERAL

- E11.1 Further to Specification CW 3325 the Contractor shall construct the proposed Monolithic Curb and 100mm Concrete Sidewalk with Block-outs for Pavers with a minimum 100mm depth of concrete below pavers. The “block-outs” shall be constructed utilizing forming techniques capable of accommodating the proposed paving stones to the dimensions and tolerances as confirmed with interlocking paving stone manufacturer.
- E11.2 A 50mm levelling course of Granular Base Course Material will be used for the Monolithic Curb and 100mm Concrete Sidewalk with Block-outs for Pavers. Quarried limestone and/or crushed concrete will **not** be acceptable.
- E11.3 The concrete sidewalk shall be poured such that the “block-outs” and remaining sidewalk act as a monolithic section.
- E11.4 All costs in connection with the additional forming and placement of concrete as a result of the “block-outs”, shall be included in the Contract Unit Price for Monolithic Curb and 100mm Concrete Sidewalk with Block-outs for Pavers.
- E11.5 Where concrete sidewalk is to be poured up to adjacent buildings, an approved bond breaker shall be supplied and installed from the base of the concrete slab up to the concrete surface. Cost of the bond breaker shall be included in the Contract Unit Price for Monolithic Curb and 100mm Concrete Sidewalk with Block-outs for Pavers.

MEASUREMENT AND PAYMENT

- E11.6 Construction of Monolithic Curb and 100mm Concrete Sidewalk with Block-outs for Pavers will be measured on an area basis and paid for at the Contract Unit Price per square metre for “Monolithic Curb and 100mm Concrete Sidewalk with Block-outs for Pavers”. The area to be paid for will be the total number of square metres constructed of Monolithic Curb and 100mm Concrete Sidewalk with Block-outs for Pavers in accordance with this Specification, accepted and measured by the Contract administrator.
- E11.7 The supply, placement and compaction of Granular Base Course Material for Monolithic Curb and 100mm Concrete Sidewalk with Block-outs for Pavers shall be included in the cost of Monolithic Curb and 100mm Concrete Sidewalk with Block-outs for Pavers and no separate measurement and payment will be made.

E12. PAVING STONES

DESCRIPTION

- E12.1 This Specification shall cover the supply and installation of paving stones and the bedding course of sand. This Specification supplements CW 3335.

MATERIALS

- E12.2 Concrete Pavers
- E12.2.1 Clay pavers shall be Endicott Clay Pavers, colour: Dark Iron Spot, 92mm x 194mm x 57mm depth.
- E12.2.2 Concrete pavers shall be Barkman Concrete Pavers, colour: Charcoal, 105mm x 210mm x 60mm depth.

CONSTRUCTION METHODS

- E12.3 All joints to be tight and not to be wider than 4 mm.

- E12.4 All pavers shall be set flush with contiguous adjacent concrete and curb materials. Sand depth to vary to ensure constant surface finish.

MEASUREMENT AND PAYMENT

- E12.5 The supplying and placing of Interlocking Paving Stones will be measured on an area basis and paid for at the Contract Unit Price per square metre for "Supply and Install Interlocking Paving Stones". The area to be paid for will be the total number of square metres of Interlocking Paving Stone supplied and placed in accordance with this Specification, accepted and measured by the Contract Administrator.
- E12.6 The supply and placement of sand bedding and infill material for interlocking paving stones is incidental to the Works and no separate measurement and payment will be made.

E13. SALVAGE EXISTING INTERLOCKING PAVING STONES

DESCRIPTION

- E13.1 This Specification shall cover the removal, stockpiling and delivery of existing interlocking paving stones.

CONSTRUCTION METHODS

- E13.2 The Contractor shall carefully remove and clean existing paving stones from the areas determined by the Contract Administrator. The contractor shall ensure the removal and cleaning methods do not chip or damage existing interlocking paving stones.
- E13.3 The Contractor shall take care when stockpiling existing interlocking paving stones on wooden pallets.
- E13.4 The Contractor shall dispose of damaged existing interlocking paving stones in accordance with section 3.4 of CW 1130.
- E13.5 Salvaged interlocking paving stones shall be delivered to the City of Winnipeg Yard, 1220 Pacific Avenue or as directed by the Contract Administrator.

MEASUREMENT AND PAYMENT

- E13.6 The salvaging of existing interlocking paving stones will be measured on an area basis and paid for at the Contract Unit Price per square metre for "Salvage Existing Interlocking Paving Stones". The area to be paid for will be the total number of square metres of existing interlocking paving stones removed, stockpiled and delivered in accordance with this Specification, accepted and measured by the Contract Administrator.
- E13.7 The supply of wooden pallets for stockpiling existing interlocking paving stones is included in the salvaging of existing interlocking paving stones and no separate measurement and payment will be made.

E14. TREE GRATES

- E14.1 Description

- (a) This Specification shall cover the supply and installation of cast iron grates for areas as indicated on the drawing. The Work to be done under this Specification shall include the furnishing of all superintendence, overhead, labour, materials, equipment, tools, supplies, and all things necessary and incidental to the satisfactory performance and completion of all Work as specified.

- E14.2 Materials

- E14.2.1 Tree Grates

- (a) Tree grates shall be narrow slotted radial cast iron grate by Neenah Foundry catalogue R-8708 – ADA compliant.

E14.3 Measurement and Payment

The supply and installation of Tree Grates will be measured on a unit basis and paid for at the Contract Unit Price each for “Supply and Install Cast Iron Tree Grate”. The Tree Grates to be paid for will be the total number of Tree Grates supplied and installed in accordance with this specification, accepted and measured by the Contract Administrator.

E15. BASE COURSE MATERIAL USE IN THE EXCHANGE DISTRICT

- E15.1 Further to CW 3110 the base course material used at the Downtown Exchange District Sidewalk Renewal as identified on Form B as “Part A” will consist of crushed gravel and will be free from organic soft material that would disintegrate through decay and weathering. The base course material will be well graded and conform to Table CW 3110.2 – Base Course Material Grading Requirements. Limestone and recycled crushed concrete pavement will not be accepted.

E16. SIDEWALK FURNITURE AND APPURTENANCES IN THE EXCHANGE DISTRICT

- E16.1 All sidewalk furniture and appurtenances as identified by the Contract Administrator are to be removed and stored by the Contractor.
- E16.2 All sidewalk furniture and appurtenances as identified by the Contract Administrator are to be reinstalled by the Contractor
- E16.3 No measurement for payment will be made for performing all operations herein described and all other items incidental to the work described

E17. TREE AND STUMP REMOVAL

- E17.1 Trees within the proposed sidewalk area as identified by the Contract Administrator are to be removed.
- E17.2 Stumps within the proposed sidewalk area as identified by the Contract Administrator are to be ground to approximately 10” below grade.
- E17.3 All treatments are to be carried out by licensed and insured Manitoba applicator as identified on the City of Winnipeg’s Urban Forestry Branch’s website. The website is as follows:
http://www.winnipeg.ca/publicworks/Forestry/Homeowner_Tree_Maintenance_Guidelines.asp
- E17.4 No measurement for payment will be made for performing all operations herein described and all other items incidental to the work described.

E18. PORTAGE AVENUE WORK HOURS

- E18.1 All Portage Avenue construction work associated with the installation of Detectable Warning Surface Tiles and sidewalk renewal will be performed between the hours of 17:30 Friday and 06:00 Monday.
- E18.2 The proposed intersections will be Fort Street/Notre Dame Avenue, Garry Street and Smith Street.
- E18.3 Pedestrian crossing access must be maintained at all times.
- E18.4 All lane closures must be pre-approved with the contract administrator prior to construction work commencing. All signing will fall under the guidelines of the Manual of Temporary Traffic Control in Work Areas on City Streets.