

ALLEY PAVEMENT PROFILE
SCALE: 1:250 HOR
1:10 VER

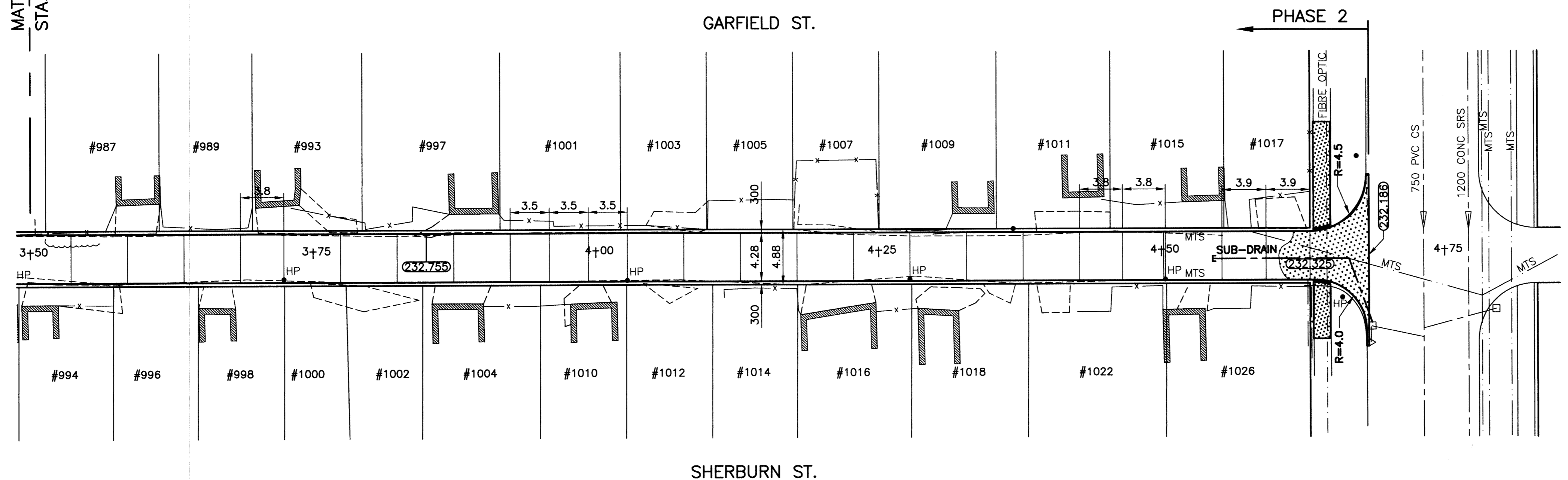

ALLEY PAVEMENT PLAN
SCALE: 1:250 HOR

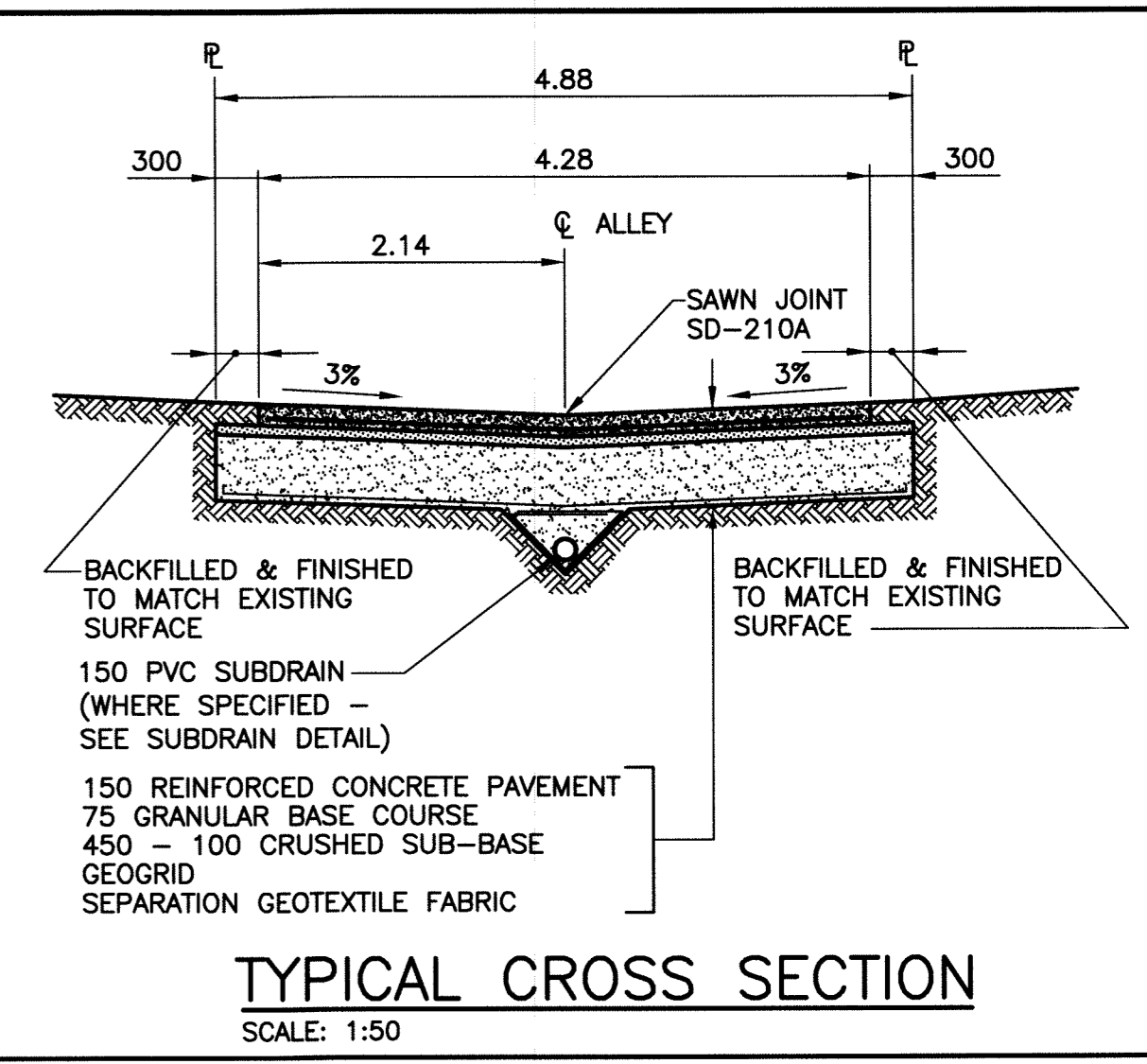

TYPICAL CROSS SECTION
SCALE: 1:50

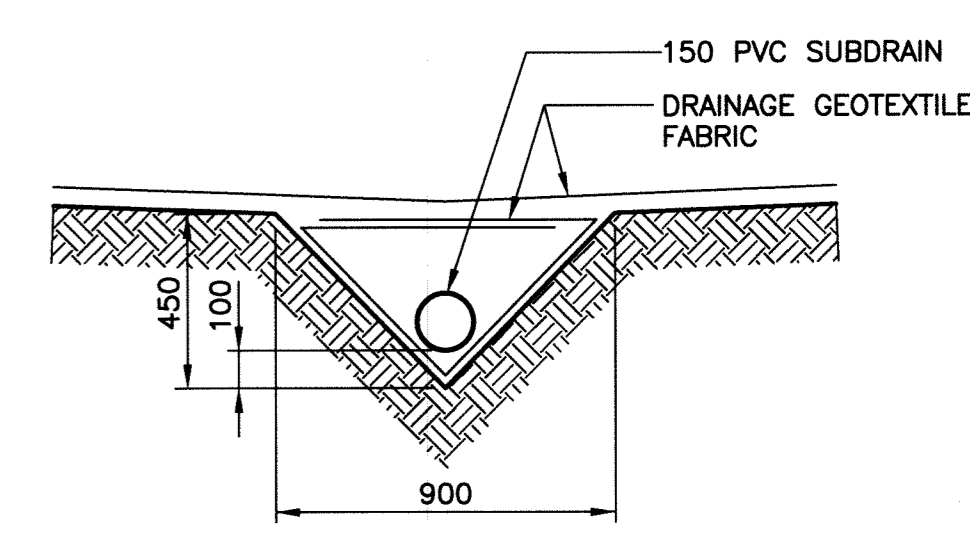

SUBDRAIN DETAIL
SCALE: 1:20

- NOTE:**
1. STATION CHAINAGE IS BASED ON CENTERLINE OF ALLEY RIGHT OF WAY.
 2. ADJUST MH AND CB RIMS TO NEW GRADES.
 3. PLUG SUBDRAINS AT TERMINAL ENDS.
 4. REGRADE EXISTING PRIVATE SIDEWALKS AS REQUIRED.
 5. INSTALLATION OF LIP CURBS AND THEIR EXTENTS TO BE DETERMINED BY THE CONTRACT ADMINISTRATOR.
 6. LIGHT STANDARDS, HYDRO POLES AND ANCHORS MAY REQUIRE TEMPORARY SUPPORT/REMOVAL OR REPLACEMENT AT THE CONTRACTOR'S EXPENSE.
 7. ISOLATE ALL POLES, BASES AND PILES WITHIN ALLEY RIGHT OF WAY (SD-228C).
 8. AVOID DAMAGE TO EXISTING TREES WITHIN THE LIMITS OF CONSTRUCTION.

PROPERTY LIMITS DELINEATION
DELINEATION OF PROPERTY LIMITS AS SHOWN ON THIS DWG DOES NOT REPRESENT A "LEGAL SURVEY". KGS GROUP MAKES NO REPRESENTATION OR WARRANTY AS TO THE ACCURACY OF PROPERTY LIMITS DELINEATED ON THIS DWG, NOR ON THE DIMENSIONAL ACCURACY OF DWG FEATURES RELATIVE TO THOSE PROPERTY LIMITS.

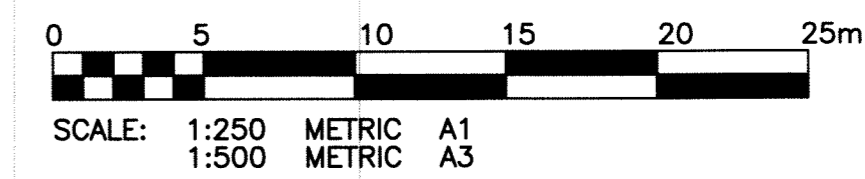
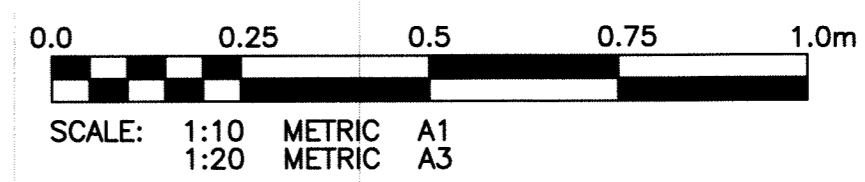
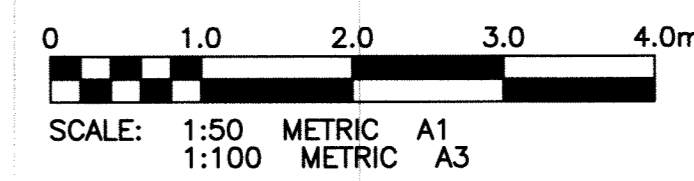

METRIC
WHOLE NUMBERS INDICATE MILLIMETRES
DECIMALIZED NUMBERS INDICATE METRES

WARNING
IF POWER EQUIPMENT OR EXPLOSIVES ARE TO BE USED FOR EXCAVATION ON THIS PROJECT THE CONTRACTOR MUST:
1) NOTIFY THE GAS COMPANY OF THE PROPOSED LOCATION OF EXCAVATION.
2) TAKE PRECAUTION TO AVOID DAMAGE TO GAS COMPANY INSTALLATIONS.
SEE PROVINCIAL REGULATION 210/72 FOR DETAILS.

P:\Projects\2011\11-0107-10\Dec.Control\obalnaud\DWG\11-0107-10_15-Rev 0.dwg - Tab: 15 Plotted By: Dberoch 06/28/2011 [Tue 8:36am] PLOT 1:1 A-1

EXISTING	LEGEND-PLAN	PROPOSED	EXISTING	LEGEND-PLAN	PROPOSED	EXISTING	LEGEND-PROFILE	PROPOSED
300 LDS	LAND DRAINAGE SEWER	300 LDS	TEST HOLE					
250 WWS	WASTE WATER SEWER	250 WWS	GUY WIRE					
	GAS		LIGHT STANDARD					
	HYDRO M.T.S.		BACK OF CURB					
150 WM	WATERMAIN	150 WM	CONCRETE					
	HYDRANT		ASPHALT					
	VALVE		SIDEWALK					
	MANHOLE		PROPERTY LINE					
	CATCH BASIN		SURVEY BAR					
	CURB INLET		GEODETIC BENCHMARK					
	POLES		ELEVATION					

LOCATION APPROVED UNDERGROUND STRUCTURES
SUPV. U/G STRUCTURES COMMITTEE DATE
NOTE:
LOCATION OF UNDERGROUND STRUCTURES AS SHOWN ARE BASED ON THE BEST INFORMATION AVAILABLE BUT NO GUARANTEE IS GIVEN THAT ALL EXISTING UTILITIES ARE SHOWN OR THAT THE GIVEN LOCATIONS ARE EXACT. CONFIRMATION OF EXISTENCE AND EXACT LOCATION OF ALL SERVICES MUST BE OBTAINED FROM THE INDIVIDUAL UTILITIES BEFORE PROCEEDING WITH CONSTRUCTION.

B.M. ELEV.	36-061 233.373	N.W. Cor. Sargent Ave. 7 Garfield St. N. Tib. in S. Conc. foundation of Sargent Ave. Memorial Church 0.5m W. & 1.7m below brick of S.E. Cor. of Bldg.
ISSUED FOR TENDER	11/06/27	MSM
REVISIONS	DATE	BY



DESIGNED BY	MSM	CHECKED BY	RBO
DRAWN BY	DMW	APPROVED BY	
HOR. SCALE:	1:250	RELEASED FOR CONSTRUCTION:	
VERTICAL:	1:50	DATE	11/06/06

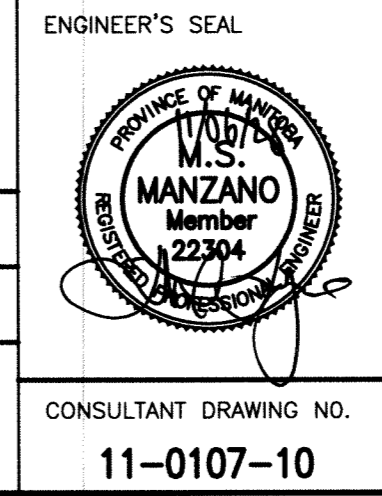

THE CITY OF WINNIPEG
PUBLIC WORKS DEPARTMENT
TRANSPORTATION ENGINEERING DIVISION

PROJECT TITLE: **2011 ALLEY RENEWAL PROGRAM**
GARFIELD ST./SHERBURN ST.
SARGENT AVE. TO WELLINGTON AVE.
STA. 3+50 TO STA. 4+75

SHEET **15** OF **18**
COMPUTER FILE NAME: **GARFIELD_SHERBURN**
CITY DRAWING NUMBER: **P-XX15**

CONSULTANT DRAWING NO. **11-0107-10**