

**MAIN FLOOR PLAN - H.V.A.C.**  
SCALE: 3/8"=1'-0"

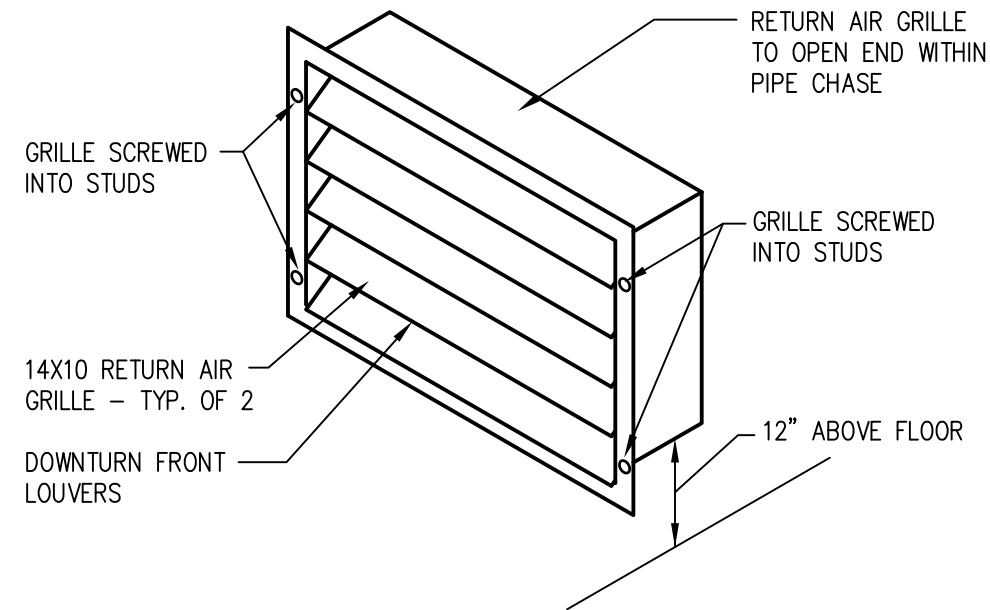

**TRANSFER RETURN AIR GRILLE**  
N.T.S.

**DRAWING NOTES - H.V.A.C.**

- 1 FAN COIL UNIT AS SPECIFIED MOUNTED SUSPENDED FROM UNDERSIDE OF STRUCTURE C/W VIBRATION ISOLATION HANGERS. CONNECT SUPPLY & RETURN DUCTWORK TO FAN COIL C/W FLEX CONNECTION.
- 2 EXHAUST FAN AS SPECIFIED MOUNTED WITHIN CEILING STRUCTURE C/W INSULATED EXHAUST DUCTWORK EXTENDING UP THROUGH ROOF.
- 3 INSULATED EXHAUST DUCTWORK EXTENDING UP THROUGH ATTIC SPACE CONNECTED TO ROOF JACK. ROOF JACK C/W BACKDRAFT DAMPER.
- 4 SIDEWALL SUPPLY AIR GRILLE AS SPECIFIED MOUNTED HIGH ON WALL CONNECTED TO FAN COIL UNIT DISCHARGE OUTLET C/W FLEX CONNECTION.
- 5 REMOTE SENSOR MOUNTED ON WALL WIRED TO THERMOSTAT WIRED TO CONTROL FAN COIL UNIT HEATING OPERATION. SENSOR C/W METAL VANDALPROOF LOCKABLE COVER.
- 6 MOTION DETECTOR MOUNTED ON WALL WIRED TO CONTROL DESIGNATED EXHAUST FAN OPERATION.
- 7 SIDEWALL TRANSFER AIR GRILLE MOUNTED LOW ON WALL OPEN ENDING WITHIN FURRED OUT WALL CAVITY. RETURN AIR GRILLES TO BE MOUNTED 12" ABOVE FLOOR LEVEL. REFER TO DETAIL ON THIS DRAWING @ RIGHT.
- 8 8X8 FRESH AIR INTAKE LOUVER MOUNTED HIGH ON WALL TRANSITION & CONNECTED TO 6"Ø INSULATED FRESH AIR INTAKE DUCTWORK CONNECTING TO FAN COIL UNIT RETURN AIR PLENUM.
- 9 TWO WIRE MESH TRANSFER AIR GRILLES. ONE MOUNTED HIGH ON WALL. ONE MOUNTED LOW ON WALL. TRANSFER AIR GRILLES TO OPEN END WITHIN FURRED OUT WALL CAVITY SPACE.
- 10 RETURN AIR DUCTWORK TO OPEN END WITHIN MECHANICAL/ELECTRICAL ROOM @ CEILING SPACE LEVEL. RETURN AIR DUCTWORK TO CONNECT TO FAN COIL UNIT RETURN AIR COLLAR CONNECTION C/W FLEX CONNECTION.
- 11 THERMOSTAT MOUNTED ON WALL WITHIN ELECTRICAL ROOM. THERMOSTAT TO BE WIRED TO CONTROL FAN COIL UNIT OPERATION INCLUDING HEATING. THERMOSTAT C/W REMOTE SENSOR MOUNTED WITHIN WASHROOM AREA.



**B.P. DESIGNS LTD.**  
39 BERUBE PLACE  
WINNIPEG, MANITOBA  
R3X - 1E4  
PHONE: 253-9613  
FAX: 257-2333

Victor Suen Architect

23 Stormont Drive, Winnipeg, MB R3V 1L9  
email: victorsuenarchitect@mts.net  
Ph (204) 228-0230 Fax (204) 261-6341

COMFORT STATION FOR WINNIPEG TRANSIT

GROUND FLOOR PLAN - H.V.A.C.

SCALE: 3/8"=1'-0"  
DATE: JUNE 3, 2013

REV. 0 13/11/29 ISSUED FOR TENDER & CONSTRUCTION

**M-2.1**  
REV 0