

SECTION 01 11 00

SUMMARY OF WORK

PART 1 GENERAL

1.1 SCOPE OF WORK

- A. The completed Work will provide the City with a fully-functional HRC system for the South End Water Pollution Control Centre (SEWPCC) Upgrading/Expansion Project.
1. The Work generally includes:
- a. Supply and delivery of Submittals, including approved shop drawings.
 - b. Design support to the Contract Administrator.
 - c. Programming support to the system integrator.
 - d. Validation of control system programming.
 - e. Training of the Installation Contractor and installation supervision and inspection.
 - f. Supply and delivery of HRC equipment.
 - g. Commissioning services including managing performance testing.
 - h. Operator training.
 - i. Operation and Maintenance Manuals.
 - j. Performance guarantee.
 - k. Adhering to the Schedule.
- B. Submittals: These Specifications require the Contractor to furnish Submittals to the Contract Administrator. Submittals shall be furnished in accordance with Section 01 33 00, Submittal Procedures and the technical Specifications. Section 01 33 00, Submittal Procedures requires the Contractor to prepare and maintain a schedule of submittals.
- C. Design Support: Shall include all supporting technical services and products described in this RFP and that may be reasonably required by the Contract Administrator and the City. Design services shall include but are not necessarily limited to:
1. Provision of information relating to the HRC system and all ancillary equipment, including but not limited to Shop Drawings requiring preparation of preliminary layouts for use by the Contract Administrator, to the Contract Administrator during design to facilitate tendering of a construction contract for the construction of the SEWPCC Upgrading/Expansion Project.
 2. Provision of operating and design process information including control philosophy, standard operating procedures, preventative maintenance schedule, equipment data and reference materials.
 3. Provision of necessary performance specifications for all supplied equipment and materials.
- D. Programming Support: Shall include all supporting technical services and products described in this RFP and that may be reasonably required by the system integrator, Contract Administrator and the City to design and implement a PLC-based control system to operate the HRC system.

- E. Control System Validation: Attendance at and participation in the Factory Acceptance Testing of the HRC system programming.
- F. Installation Support:
 - 1. All necessary instruction and supervision to ensure satisfactory off-loading, storage, and installation of the equipment.
 - 2. Witnessing and certification of equipment installation.
 - 3. Completion of all necessary forms.
- G. Supply and Delivery of HRC Equipment:
 - 1. HRC system including but not limited to mixers, clarifier mechanisms, lamella system and effluent troughs, pumps, ballast (if applicable), ballast recovery system (if applicable), ballast addition system (if applicable), air scour blower, valves and operators, ancillaries and instrumentation & control components.
 - 2. Appurtenances not specifically mentioned or included in the Contract but which are necessary as part of the Work to ensure that the equipment is fully functional.
- H. Commissioning Services: Preparation of an approved Performance Demonstration Plan, participation in functional testing and management of performance testing.
- I. Operator Training: Development of training materials and provision of training of the City's operations and maintenance staff.
- J. Operations and Maintenance Manuals: Development and submission of approved operations and maintenance manuals.
- K. Performance Guarantees: As required and at no cost to the City, modification and or replacement of the equipment to ensure that specified performance guarantees are met.
- L. Warranty: Provision of all technical support for and repair of all defects to the equipment, at no cost to the City, during the warranty period.
- M. Schedule: Deliver the Work in accordance with the schedule stated in the Supplemental Conditions.

1.2 COORDINATION

- A. The Contractor is advised that at any given time at the Site there may be others that will be working within and/or adjacent to the HRC system, including but not necessarily limited to:
 - 1. City staff
 - 2. City-appointed representatives
 - 3. Contract Administrator
 - 4. Other contractors and their sub-contractors.
- B. Coordinate site services with the Contract Administrator and Installation Contractor. Cooperate with the Installation Contractor (or Contract Administrator if the Installation Contractor has yet to be assigned) to ensure the Work conforms to the overall project schedule.

PART 2 PRODUCTS

2.1 GENERAL

- A. HRC to be provided in accordance with Section 46 43 80, High Rate Clarification System which provides an overview of the HRC system and provides overall design and implementation requirements. Other Sections as referenced therein provide further details for HRC component design and implementation.

PART 3 EXECUTION

3.1 ROLES AND RESPONSIBILITIES

- A. Refer to the Responsibilities Matrix attached as a Supplement to this Section.

3.2 SUPPLEMENTS

- A. The supplements listed below, following “End of Section”, are part of this Specification.
 - 1. Responsibilities Matrix.

END OF SECTION

SECTION 01 11 00, SUMMARY OF WORK – SUPPLEMENT

RESPONSIBILITIES MATRIX

| Item | Description | Contractor | Installation Contractor | System Integrator | Contract Administrator |
|--|--|-------------------|--------------------------------|--------------------------|-------------------------------|
| ADMINISTRATION | | | | | |
| 1 | Insurances | X | X | X | X |
| 2 | Performance Security | X | X | X | |
| 3 | Overall SEWPCC Upgrading / Expansion project schedule | | X | | X |
| 4 | Schedule of Submittals | X | | | |
| 5 | HRC system monthly status report | X | | | |
| 6 | Contract drawings for HRC facility construction | | | | X |
| 7 | Submission of product samples | X | | | |
| 8 | Contractor design data | X | | | |
| 9 | Contractor's instructions for equipment offloading and storage | X | | | |
| 10 | Contractor's instructions for equipment installation | X | | | |
| 11 | Material Safety Data Sheets | X | | | |
| 12 | Special tools lists | X | | | |
| 13 | Spare parts lists | X | | | |
| 14 | Ballast technical specification, if applicable | X | | | |
| 15 | Qualifications of Contractor's representative | X | | | |
| 16 | Training session recordings | X | | | |
| 17 | O&M manuals | X | | | |
| 18 | Performance guarantees | X | | | |
| 19 | Warranty | X | X | X | |
| ENGINEERING AND DESIGN SERVICES | | | | | |
| 20 | Design support to Contract Administrator | X | | | |
| 21 | Development of final plant-wide P&IDs incorporating shop drawing P&IDs submitted by Contractor | | | | X |
| 22 | Review and validation of final plant-wide P&IDs | X | | | |
| 23 | Programming support to System Integrator | X | | | |
| 24 | Engage engineer licensed in Manitoba for work required to be designed by an engineer | X | | | |

SEWPCC UPGRADING/EXPANSION PROJECT
RFP NO. 873-2013

| Item | Description | Contractor | Installation Contractor | System Integrator | Contract Administrator |
|--------------------------------------|--|------------|-------------------------|-------------------|------------------------|
| 25 | Shop Drawings including general arrangement drawings | X | | | |
| 26 | “As-Built” shop drawings | X | | | |
| 27 | “As-Built” drawings for the constructed HRC facility | | X | | |
| 28 | Electrical single-line diagram | | | | X |
| 29 | Design of the HRC master control panel | | | | X |
| 30 | Control narrative / control philosophy | X | | | |
| 31 | Post-disaster structure design certification | X | | | |
| EQUIPMENT SUPPLY AND DELIVERY | | | | | |
| 32 | Concrete tanks | | X | | |
| 33 | Mixers and motors | X | | | |
| 34 | Mixer support concrete slabs | | X | | |
| 35 | Sludge scraper assemblies and drives (circular or rectangular) | X | | | |
| 36 | Circular sludge scraper assembly support bridges with grating and handrails | X | | | |
| 37 | Rectangular sludge scraper access platforms | | X | | |
| 38 | Grating and handrail (other than for circular sludge scraper assembly support bridges) | | X | | |
| 39 | Lamella modules and supports | X | | | |
| 40 | Effluent troughs, weirs and supports | X | | | |
| 41 | Air scour blower with suction and discharge isolation valves | X | | | |
| 42 | Air scour flow control valves | X | | | |
| 43 | Air scour piping and supports below the lamella packs and air supply piping to the edge of the HRC tank | X | | | |
| 44 | Air supply piping beyond the HRC tank | | X | | |
| 45 | Recirculation pumps with suction and discharge isolation valves and discharge check valve (if recommended) | X | | | |

SEWPCC UPGRADING/EXPANSION PROJECT
RFP NO. 873-2013

| Item | Description | Contractor | Installation Contractor | System Integrator | Contract Administrator |
|------|--|------------|-------------------------|-------------------|------------------------|
| 46 | Motorized cross-connection valves if shared standby recirculation pump configuration is used | X | | | |
| 47 | Recirculation piping | | X | | |
| 48 | Ballast (if applicable) | X | | | |
| 49 | Ballast addition system including slurry control valves (if applicable) | X | | | |
| 50 | Ballast recovery system (if applicable) | X | | | |
| 51 | Ballast slurry and ballast/sludge piping | | X | | |
| 52 | Plant effluent water (W3) booster pump system (if required) | | X | | |
| 53 | Internal tank fabricated metal components such as transfer chutes, draft tubes, mixing tank baffles, polymer distribution ring, etc. | X | | | |
| 54 | Scum removal system | X | | | |
| 55 | Scum piping beyond the HRC tank | | X | | |
| 56 | Sludge wasting flow control valves (if applicable) | X | | | |
| 57 | Sludge sampling system (if required) | X | | | |
| 58 | Anchors and hardware | X | | | |
| 59 | Coagulant storage and metering system | | X | | |
| 60 | Polymer storage and metering system | | X | | |
| 61 | Alkalinity addition system | | X | | |
| 62 | Anti-foam system | | X | | |
| 63 | Sludge wasting and scum pumps | | X | | |
| 64 | HRC system inlet and outlet valves/gates | | X | | |
| 65 | Flow meters | | X | | |
| 66 | Pressure indicating transmitters | | X | | |
| 67 | Level indicating transmitters | | X | | |
| 68 | Sludge blanket indicators | X | | | |
| 69 | Turbidimeters | X | | | |
| 70 | pH meters | X | | | |

SEWPCC UPGRADING/EXPANSION PROJECT
RFP NO. 873-2013

| Item | Description | Contractor | Installation Contractor | System Integrator | Contract Administrator |
|----------------------|--|------------|-------------------------|-------------------|------------------------|
| 71 | Other interconnecting piping and connections to processes beyond the HRC | | X | | |
| 72 | Tank drain valves | | X | | |
| 73 | MCCs, VFDs, electrical panels, wires/cables and associated installation | | X | | |
| 74 | Supply of the HRC master control panel | | X | | |
| 75 | Fabrication of HRC equipment in accordance with approved shop drawings | X | | | |
| 76 | Factory test and inspection reports and other QC documentation | X | | | |
| 77 | Contractor's Certificate of Compliance with the specifications | X | | | |
| 78 | PLC programming of the HRC master control panel | | | X | |
| 79 | Participation in Factory Acceptance Testing of the HRC master control panel programming | X | | X | X |
| 80 | Equipment and spare parts delivery, f.o.b. Site | X | | | |
| 81 | Equipment offloading and storage | | X | | |
| 82 | Delivered equipment inspection and completion of Form 100 | X | | | |
| SITE SERVICES | | | | | |
| 83 | Abide by City's Health & Safety requirements | X | X | X | X |
| 84 | Training of the Installation Contractor and completion of Form 101 | X | | | |
| 85 | Installation of all HRC equipment | | X | | |
| 86 | Field welding, field assembly, field painting and coating, and coating touch-ups to field damaged finishes | | X | | |
| 87 | Supervision and inspection of installation and completion of Form 102 | X | | | X |
| 88 | Development of approved training materials | X | | | |
| 89 | Training of City staff and completion of forms T-1 and T-2 | X | | | |
| 90 | Performance Demonstration Plan | X | | | |

SEWPCC UPGRADING/EXPANSION PROJECT
RFP NO. 873-2013

| Item | Description | Contractor | Installation Contractor | System Integrator | Contract Administrator |
|-----------------|--|------------|-------------------------|-------------------|------------------------|
| 91 | Unit process startup forms | X | | | |
| 92 | Attendance at a HRC facility startup meeting | X | X | X | X |
| 93 | Perform functional testing | | X | X | |
| 94 | Functional testing support and completion of equipment test reports and completion of Form 103 | X | | | |
| 95 | Management of performance testing, recording of any additional data and completion of Form 104 | X | | | |
| 96 | Select an independent lab for performance test sample analysis. | | | | X |
| 97 | Conduct performance testing and furnish all needed samplers and temporary instruments | X | X | | |
| 98 | Write and submit Performance Test Report | X | | | |
| 99 | Pay for costs of functional and performance testing (except performance test sample analysis) | | X | | |
| 100 | Collect performance test samples, ship and pay for laboratory analysis | X | | | |
| WARRANTY | | | | | |
| 101 | Replace defective equipment during the warranty period | X | | | |

SECTION 01 33 00

SUBMITTAL PROCEDURES

PART 1 GENERAL

1.1 DEFINITIONS

- A. Submittal: Written and graphic information submitted by Contractor, that requires Contract Administrator's review. Submittals not meeting conditions of the Contract will be returned.
- B. Shop Drawings: Custom drawings, product data, diagrams, illustrations, schedules, performance charts, brochures and other data, which are to be provided by the Contractor to illustrate details of a portion of the Work.

1.2 SUBMITTAL PROCEDURES

- A. Direct submittals to Contract Administrator.
- B. The Contractor may be required to follow the City's procedures regarding submittals of electronic files in the City Document Management System (DMS), transmission of electronic submittals and identification of project specific documents and equipment at no cost to the City.
- C. Electronic Submittals: Submittals made in electronic format shall be as follows:
 - 1. Each submittal shall be electronic files in Adobe Acrobat Portable Document Format (PDF) and native files (e.g. Word, Excel, AutoCad, etc.). Use latest version available at time of execution of the Contract.
 - 2. Electronic files that contain more than 10 pages in PDF format shall contain internal book marking from index page to major sections of document.
 - 3. PDF files shall be set to open "Bookmarks and Page" view.
 - 4. Add general information to each PDF file, including title, subject, author, and keywords.
 - 5. PDF files shall be set up to print legibly on paper sizes 8.5 inches by 11 inches, or 11 inches by 17 inches, or 22 inches by 34 inches. No other paper sizes will be accepted.
 - 6. Submit new electronic files for each resubmittal.
 - 7. Include copy of Transmittal of Contractor's Submittal form, located at end of section, with each electronic file.
 - 8. Contract Administrator will reject submittals that are not accompanied by an electronic copy.
 - 9. Provide Contract Administrator with authorization to reproduce and distribute each file as many times as necessary for Project documentation.

- D. Schedule of Submittals: Prepare a table listing all anticipated submittals required to complete the Work.
1. Show for each specification section, at a minimum, the following:
 - a. Specification section number.
 - b. Total number of submittals for each specification section.
 - c. Identify each submittal by its submittal number in accordance with the numbering and tracking system as specified under Clause 1.2E, Transmittal of Submittal.
 - d. Identify each submittal by its name or title.
 - e. Identify the estimated date of submission to the Contract Administrator.
 - f. State the submittal revision number and status for each submittal.
 2. On a monthly basis, submit an updated Schedule of Submittals to the Contract Administrator if changes have occurred.
- E. Transmittal of Submittal:
1. Contractor shall:
 - a. Review each submittal prior to submission and check for compliance with the Contract.
 - b. Stamp each submittal with uniform approval stamp before submitting to Contract Administrator.
 - 1) Stamp to include Project name, submittal number, Specification number, Contractor's reviewer name, date of Contractor's approval, and statement certifying that submittal has been reviewed, checked, and approved for compliance with the Contract.
 - 2) Contract Administrator will not review submittals that do not bear Contractor's approval stamp, and will return them without action.
 - 3) Contract Administrator will not review submittals received directly from a Subcontractor and will return them without action.
 2. Complete, sign, and transmit with each submittal package, one Transmittal of Contractor's Submittal form attached at end of this section.
 3. Identify each submittal with the following:
 - a. Numbering and Tracking System:
 - 1) Sequentially number each submittal.
 - 2) Resubmission of submittal shall have original number with sequential alphabetic suffix.
 - b. Specification section and paragraph to which submittal applies.
 - c. Project title and Bid Opportunity number.
 - d. Date of transmittal.
 - e. Name of Contractor.
 4. Identify and describe each deviation or variation from the Contract.
- F. Format:
1. Do not base Shop Drawings on reproductions of contract documents.

2. Package submittal information by individual Specification section. Do not combine different Specification sections together in submittal package, unless otherwise directed in Specification.
 3. Present in a clear and thorough manner and in sufficient detail to show kind, size, arrangement, and function of components, materials, and devices, and compliance with the Contract.
 4. Index with labeled tab dividers in orderly manner.
- G. Timeliness:
1. Schedule and submit in accordance with schedule of submittals, and requirements of individual Specification sections.
 2. Submit Shop Drawings and Samples well in advance of scheduled delivery date for associated equipment or material and in an orderly sequence so as to cause no delay in the Work.
 3. Failure to submit Shop Drawings and Samples in ample time is not to be considered sufficient reason for an extension of the schedule outlined in the Supplemental Conditions and no claim for extension by reason of such default will be allowed.
- H. Processing Time:
1. Time for review shall commence on Contract Administrator's receipt of submittal.
 2. Contract Administrator will act upon Contractor's submittal and transmit response to Contractor not later than 10 Working Days after receipt.
 3. Resubmittals will be subject to same review time.
- I. Resubmittals:
1. Clearly identify each correction or change made and include revision date.
 2. No adjustment of the schedule outlined in the Supplemental Conditions or Contract Price will be allowed due to delays in progress of Work caused by rejection and subsequent resubmittals.
- J. Incomplete Submittals:
1. Contract Administrator will return entire submittal for Contractor's revision if preliminary review deems it incomplete.
 2. When any of the following are missing, submittal will be deemed incomplete:
 - a. Contractor's review stamp, completed and signed.
 - b. Transmittal of Contractor's Submittal, completed and signed.
 - c. Insufficient number of copies.
 - d. All requested information is not provided.
 - e. Submittals missing Professional Engineer's seal and signature, where it is required.
- K. Submittals not required by the Contract:
1. Will not be reviewed and will be returned stamped RECEIVED FOR INFORMATION.
 2. Contract Administrator will keep one copy and return all remaining copies to Contractor.

- L. Submittal Disposition: Contract Administrator will review, mark, and stamp as appropriate, and distribute marked-up copies or submittal review comment forms as noted:
1. NO EXCEPTIONS TAKEN (NET):
 - a. Contractor may incorporate product(s) or implement Work covered by submittal.
 - b. Distribution:
 - 1) One copy furnished to City.
 - 2) One copy retained in Contract Administrator's file.
 - 3) Remaining copies returned to Contractor appropriately annotated.
 2. EXCEPTIONS NOTED (EN):
 - a. Contractor may incorporate product(s) or implement Work covered by submittal, in accordance with Contract Administrator's notations.
 - b. Distribution:
 - 1) One copy furnished to City.
 - 2) One copy retained in Contract Administrator's file.
 - 3) Remaining copies returned to Contractor appropriately annotated.
 3. EXCEPTIONS NOTED - RESUBMIT (ENR):
 - a. Make corrections or obtain missing portions, and resubmit.
 - b. Contractor may not incorporate product(s) or implement Work covered by submittal, except portions where indicated Contractor may begin to incorporate product(s) or implement Work covered by the submittal in accordance with the Contract Administrator's notations.
 - c. Distribution:
 - 1) One copy furnished to City.
 - 2) One copy retained in Contract Administrator's file.
 - 3) Remaining copies returned to Contractor appropriately annotated.
- M. Do not revise submittals after they have been reviewed and stamped NO EXCEPTIONS TAKEN or EXCEPTIONS NOTED.

1.3 SUBMITTALS

- A. General:
1. Copies: Submit one electronic copy to Contract Administrator. Method of electronic submission to be coordinated with Contract Administrator after execution of the Contract. Submit hard copies only where specifically required under individual Specification sections.
 2. Prepare and submit Submittals required by individual Specification sections.
 3. Contract Administrator will review Submittals for general conformance with design concept and intent, and general compliance with the Contract.
 4. Contract Administrator's review does not relieve Contractor from compliance with requirements of the Contract or from errors in submittals or Contractor's design.

5. Contractor is responsible for confirmation of dimensions at jobsite; fabrication processes; means, methods, techniques, sequences and procedures of construction; coordination of work of all trades; and performance of Work in safe and satisfactory manner.
 6. At Contract Administrator's option, Contract Administrator's review comments and review stamp will be placed either directly on submitted copies of submittals or on separate submittal review comment form.
 7. Where work is to be designed by Contractor, comply with applicable codes and furnish submittals signed and sealed by professional engineer licensed in Province of Manitoba, as required by Specifications. If requested, calculations shall be submitted for review. Calculations shall also be signed and sealed by a Professional Engineer registered in the Province of Manitoba.
- B. Project Status Report:
1. Submit a typewritten status report at the end of each month to the Contract Administrator, stating the status and progress of the Work, such as shop drawings, design, fabrication, shipping and delivery of the equipment and site services.
- C. Shop Drawings:
1. Arrange for the preparation of clearly identified Shop Drawings as specified or as the Contract Administrator may reasonably request.
 2. Note compliance or deviation from Specifications with full explanation for any deviations.
 3. Copies: eight (8) hard copies and one (1) electronic copy.
 4. Identify and Indicate:
 - a. Applicable Contract Drawing and Detail number, products, units and assemblies, and system or equipment identification or tag numbers.
 - b. Equipment and Component Title: Identical to title shown on Drawings.
 - c. Critical field dimensions and relationships to other critical features of Work. Note dimensions established by field measurement.
 - d. Project-specific information drawn accurately to scale. .
 5. Contractor's standard schematic drawings and diagrams as follows:
 - a. Modify to delete information that is not applicable to the Work.
 - b. Supplement standard information to provide information specifically applicable to the Work.
 6. Product Data: Provide as specified in individual Specifications.
 7. Foreign Contractors: When proposed, include the following additional information:
 - a. Names and addresses of at least two companies that maintain technical service representatives close to Site.
 8. Units: Submit all Shop Drawings in SI metric units.
- D. Samples:
1. Copies: Two, unless otherwise specified in individual Specifications.
 2. Preparation: Mount, display, or package Samples in manner specified to facilitate review of quality. Attach label on unexposed side that includes the following:
 - a. Contractor name.

- b. Model number.
 - c. Material.
 - d. Sample source.
 3. Contractor Color Chart: Units or sections of units showing full range of colors, textures, and patterns available.
 4. Full-size Samples:
 - a. Size as indicated in individual Specification section.
 - b. Prepared from same materials to be used for the Work.
 - c. Cured and finished in manner specified.
 - d. Physically identical with product proposed for use.
 5. Make Contract Administrator required changes in samples consistent with the Contract.
 6. Do not use materials in Work which are in any way inferior to Samples submitted and reviewed. Match accepted samples.
 7. Review of samples notwithstanding, materials that are unsound or imperfect when delivered to site will be rejected.
- E. Certificates:
1. Welding: In accordance with individual Specification sections.
 2. Installer: Prepare written statements on Contractor's letterhead certifying installer complies with requirements as specified in individual Specification section.
 3. Material Test: Prepared by qualified testing agency, on testing agency's standard form, indicating and interpreting test results of material for compliance with requirements.
 4. Certificates of Successful Testing or Inspection: Submit when testing or inspection is required by Laws and Regulations or governing agency or specified in individual Specification sections.
 5. Certificates as required by Section 01 43 33, Contractor's Field Services.
- F. Contractor - Design Data:
1. Written and graphic information.
 2. List of assumptions.
 3. List of performance and design criteria.
 4. Summary of loads or load diagram, if applicable.
 5. Calculations.
 6. List of applicable codes and regulations.
 7. Name and version of software.
 8. Information requested in individual Specification section.
 9. Seal and signature of professional engineer licensed in the Province of Manitoba.
- G. Contractor's Instructions: Written or published information that documents Contractor's recommendations, guidelines, and procedures in accordance with individual Specification sections.
- H. Operation and Maintenance Data: As required in Section 01 78 23, Operation and Maintenance Data

- I. Payment:
 - 1. Application for Payment: In accordance with the Supplemental Conditions.
 - 2. Schedule of Values: In accordance with the Supplemental Conditions
 - 3. Schedule of Estimated Progress Payments: In accordance with the Supplemental Conditions

- J. Quality Control Documentation: As required in Section 01 45 16.13, Quality Control.

- K. Special Guarantee: Contractor's written guarantee as required in individual Specification sections.

- L. Statement of Qualification: Evidence of qualification, certification, or registration as required in the Contract to verify qualifications of engineers, materials testing laboratories, specialty Subcontractors, trades, Specialists, consultants, and other professionals.

- M. Submittals Required by Laws, Regulations, and Governing Agencies:
 - 1. Submit promptly notifications, reports, certifications, payrolls, and otherwise as may be required, directly to the applicable federal, provincial, or local governing agency or their representative.
 - 2. Transmit to Contract Administrator for City's records one copy of correspondence and transmittals (to include enclosures and attachments) between Contractor and governing agency.

- N. Test, Evaluation, and Inspection Reports:
 - 1. General: Shall contain signature of person responsible for test or report.
 - 2. Factory:
 - a. Identification of product and Specification section, type of inspection or test with referenced standard or code.
 - b. Date of test, Project title and number, and name and signature of authorized person.
 - 1) Date of test shall be communicated to the Contract Administrator at least ten (10) working days in advance of the test.
 - c. Test results.
 - d. If test or inspection deems material or equipment not in compliance with the Contract, identify corrective action necessary to bring into compliance.
 - e. Provide interpretation of test results, when requested by Contract Administrator.
 - f. Other items as identified in individual Specification sections.
 - 3. Field: As a minimum, include the following:
 - a. Project title and number.
 - b. Date and time.
 - c. Record of temperature and weather conditions.
 - d. Identification of product and Specification section.
 - e. Type and location of test, sample, or inspection, including referenced standard or code.

- f. Date issued, testing laboratory name, address, and telephone number, and name and signature of laboratory inspector.
 - g. If test or inspection deems material or equipment not in compliance with the Contract, identify corrective action necessary to bring into compliance.
 - h. Provide interpretation of test results, when requested by Contract Administrator.
 - i. Other items as identified in individual Specification sections.
- O. Testing and Startup Data: In accordance with Section 01 43 33, Contractor's Field Services.
- P. Training Data: In accordance with Section 01 43 33, Contractor's Field Services.
- Q. Spare Parts List:
- 1. The recommended spare parts list will be used by the City as a guide for planning suitable spare parts inventory prior to acceptance of the equipment.
 - 2. Submit updated spare parts list indicating spare parts handed over to the City

PART 2 PRODUCTS (Not Used)

PART 3 EXECUTION

3.1 SUPPLEMENTS

- A. The supplements listed below, following "End of Section", are part of this Specification.
- 1. Forms: Transmittal of Contractor's Submittal

END OF SECTION

| | | |
|---|---|-------------|
|  CH2MHILL | TRANSMITTAL OF CONTRACTOR'S SUBMITTAL (ATTACH TO EACH SUBMITTAL) | DATE: _____ |
| TO: CH2M HILL CANADA LIMITED _____ ATTN: Barry Williamson _____ 1301 Kenaston Blvd _____ Winnipeg, MB R3P 2P2 _____ 204.488.2214 _____ FROM: _____ <div style="text-align: center;">Contractor</div> _____ _____ _____ | Submittal No.: _____ <input type="checkbox"/> New Submittal <input type="checkbox"/> Resubmittal Project: SEWPCC Equipment Supply – HRC System Project No.: RFP No. 873-2013 _____ Specification Section No.: _____ (Cover only one section with each transmittal) Schedule Date of Submittal: _____ _____ | |
| SUBMITTAL TYPE: <input type="checkbox"/> Shop Drawing <input type="checkbox"/> Sample <input type="checkbox"/> Informational | | |

The following items are hereby submitted:

| Number of Copies | Description of Item Submitted (Type, Size, Model Number, Etc.) | Spec. and Para. No. | Drawing or Brochure Number | Contains Variation to Contract | |
|------------------|--|---------------------|----------------------------|--------------------------------|-----|
| | | | | No | Yes |
| | | | | | |
| | | | | | |
| | | | | | |
| | | | | | |
| | | | | | |
| | | | | | |
| | | | | | |
| | | | | | |
| | | | | | |
| | | | | | |

Contractor hereby certifies that (i) Contractor has complied with the requirements of the Contract in preparation, review, and submission of designated Submittal and (ii) the Submittal is complete and in accordance with the Contract and requirements of laws and regulations and governing agencies.

By: _____
Contractor (Authorized Signature)

SECTION 01 43 33

CONTRACTOR'S FIELD SERVICES

PART 1 GENERAL

1.1 DEFINITIONS

- A. Facility: The high-rate clarification system.
- B. Facility Performance Demonstration:
 - 1. A demonstration conducted by the Installation Contractor, with assistance of the Contractor, to demonstrate and document the performance of the operating Facility, both manually and automatically, based on criteria developed in conjunction with the City and as accepted by Contract Administrator.
 - 2. Such demonstration is for the purposes of (i) verifying to the City and Contract Administrator the Facility performs as a whole, and (ii) documenting performance characteristics of the completed Facility for the City's records.
- C. Functional Testing: Tests conducted in the presence of the Contract Administrator to demonstrate that installed equipment meets Contractor's installation, calibration, and adjustment requirements and other requirements as specified.
- D. Performance Testing: Tests performed in the presence of the Contract Administrator and after any required functional testing, to demonstrate and confirm the Facility meets the specified performance requirements.
- E. Person-Day: One person for 8 hours within regular Contractor working hours.
- F. Unit process: A portion of the Facility that performs a specific process function.

1.2 SUBMITTALS

- A. Submittals:
 - 1. Qualifications of Contractor's Representative
 - 2. Contractor's Certificate of Compliance
 - 3. Form 100: Certificate of Equipment Delivery
 - 4. Form 101: Certificate of Readiness to Install
 - 5. Performance Demonstration Plan
 - 6. Unit Process Startup Forms
 - 7. Form 102: Certificate of Satisfactory Installation
 - 8. Training Materials and Agenda: Submit draft training materials and agenda not less than 21 Calendar Days prior to the first scheduled training session.
 - 9. Training Session Recording: Furnish Contract Administrator with two complete sets of DVD discs fully indexed and cataloged with printed label stating session and date recorded.
 - 10. Form T-1: Certificate of Satisfactory Classroom Training
 - 11. Form T-2: Certificate of Satisfactory Field Training

12. Functional test results (equipment test reports)
13. Form 103: Certificate of Equipment Satisfactory Performance
14. Performance test report
15. Form 104: Certificate of Satisfactory Process Performance

1.3 QUALIFICATION OF CONTRACTOR'S REPRESENTATIVE

- A. Authorized representative of the Contractor, factory trained, and experienced in the technical applications, installation, operation, and maintenance of respective equipment with full authority by the Contractor to issue the certifications required of the Contract. Additional qualifications may be specified elsewhere.
- B. Contractor's representative is subject to acceptance by Contract Administrator. No substitute representatives will be allowed unless prior written approval by such has been given.

PART 2 PRODUCTS (Not Used)

PART 3 EXECUTION

3.1 SAFETY HEALTH AND ENVIRONMENT

- A. Adhere to the Winnipeg Sewage Treatment Program Integrated Management System Contractor Safety Health and Environment Plan attached to this Section as a Supplement.

3.2 CONTRACTOR'S CERTIFICATE OF COMPLIANCE

- A. A Contractor's Certificate of Compliance, a copy of which is attached to this Section, shall be completed in full and submitted prior to shipment of product or material or execution of the services.
- B. Contract Administrator may permit use of certain materials or assemblies prior to sampling and testing if accompanied by accepted Certificate of Compliance.
- C. The form shall certify that the proposed product or material specified conforms to or exceeds specifications. Attach supporting reference data, affidavits, and certifications as appropriate.
- D. May reflect recent or previous test results on material or product, if acceptable to Contract Administrator.

3.3 EQUIPMENT DELIVERY

- A. The Installation Contractor shall be responsible for receiving, off-loading, and placing into storage all equipment at the Site. Certificate of Equipment Delivery (Form 100), a copy of which is attached to this Section, shall be completed.

3.4 FULFILLMENT OF SPECIFIED MINIMUM SERVICES

- A. Furnish Contractor's services when required by an individual specification section, to meet the requirements of this Section.
- B. Where time is necessary in excess of that stated in the Specifications for Contractor's services, or when a minimum time is not specified, the time required to perform the specified services shall be considered incidental.
- C. Determine, before scheduling travel to Site, that all conditions necessary to allow successful testing have been met.
- D. Only those days of service approved by Contract Administrator will be credited to fulfill the specified minimum services.

3.5 INSTALLATION ASSISTANCE

- A. The Contractor shall arrange via the Contract Administrator for the attendance of its representative to meet with the Installation Contractor to provide instructions in the methods, techniques, precautions, and any other information relevant to the successful installation of the equipment prior to commencing installation of equipment. All necessary documentation required for the successful installation of the equipment shall have been provided and accepted by the Contract Administrator in advance of the Contractor's representatives attendance
- B. The Contractor shall inform the Contract Administrator, in writing, of the attendance at the Site of any Contractor's Representative for installation training at least fourteen (14) days prior to arrival.
- C. When the Contractor is satisfied that the Installation Contractor is aware of all installation requirements, he shall so certify by completing the Certificate of Readiness to Install (Form 101), attached to this Specification.
- D. The completed form shall be delivered to the Contract Administrator prior to departure of the Contractor's representative from the Site.
- E. Installation of the equipment shall not commence until the Contract Administrator has advised that the completed Certificate of Readiness to Install (Form 101) has been received.
- F. Separate copies of Form 101 shall be used for each individual unit process item of equipment.
- G. If necessary, or if so directed by the Contract Administrator during the course of installation, the Installation Contractor shall contact the Contractor to receive clarification of installation procedures, direction, or any other additional information necessary to continue or complete the installation in an appropriate manner.

- H. After installation by the Installation Contractor is complete, the Contractor's representative shall verify successful installation.
- I. The Contractor's representative shall conduct a detailed inspection of the installation including alignment, mechanical connections, piping, lubrication, workmanship, and all other items as required to ensure successful operation of the equipment.
- J. The Contractor's representative shall identify any outstanding deficiencies in the installation.
- K. The deficiencies shall be rectified by the Installation Contractor and the Contractor's Representative shall re-inspect the installation.
- L. When the Contractor's representative accepts the installation, he shall certify the installation by completing Certificate of Satisfactory Installation (Form 102), attached to this Specification.
- M. Deliver the completed Certificate of Satisfactory Installation (Form 102) to the Contract Administrator prior to departure of the Contractor's representative from the Site.
- N. Tag the equipment with a 100 mm x 200 mm card stating "EQUIPMENT CHECKED. DO NOT RUN." stencilled in large black letters. Sign and date each card.
- O. Separate copies of Form 102 shall be furnished for each individual unit process item of equipment. In addition, furnish a copy of Form 102 for the entire system supplied under this Contract.

3.6 PERFORMANCE DEMONSTRATION PLAN

- A. Develop a written plan, with the assistance of the Installation Contractor, the Contract Administrator, and the City's operations personnel to include the following:
 - 1. Functional Testing: Unit Process Startup Form (sample attached), to minimally include the following:
 - a. Description of the unit process, including equipment numbers/nomenclature of each item of equipment and all included devices.
 - b. Detailed procedure for startup of the unit process, including valves to be opened/closed, order of equipment startup, etc.
 - c. Startup requirements for each unit process, including water, power, chemicals, etc.
 - d. Space for evaluation comments.
 - e. Details such as how test will be performed including sample collection and analysis
 - f. Certificate of Equipment Satisfactory Performance (Form 103)
 - 2. Performance Testing:
 - a. Detailed test schedule, test methods, materials, chemicals and liquids required, facilities operations interface all in conformance with the performance test protocol of Section 46 43 80, High Rate Clarification System.

- b. Roles and responsibilities of the various parties to the test.
 - c. Details such as how samples will be collected, analyzed and chain of custody.
 - d. Certificate of Satisfactory Process Performance (Form 104)
- B. Submit draft plant to Contract Administrator for review and approval. Revise as necessary for Contract Administrator's acceptance.
- C. Facility Startup Meeting: The Contractor shall participate in a Facility Startup Meeting to discuss Performance Demonstration Plan including schedule, methods, materials, chemicals and liquids required, facilities operations interface, and Owner involvement for the equipment and materials supplied under this Contract.

3.7 FUNCTIONAL VERIFICATION

- A. After the installation has been verified and any identified deficiencies have been remedied, equipment shall be subjected to functional testing. Ready-to-test determination will be by the Contract Administrator based at least on the following:
- 1. Adequate completion of work adjacent to, or interfacing with, equipment to be tested, including items to be furnished by Others.
 - 2. Equipment and electrical tagging complete.
 - 3. Delivery of all spare parts and special tools.
 - 4. Availability and acceptability of Contractor's representative to assist in testing of respective equipment.
 - 5. Receipt of:
 - a. Contractor's Certificate of Compliance
 - b. Certificate of Equipment Delivery (Form 100)
 - c. Certificate of Readiness to Install (Form 101)
 - d. Certificate of Satisfactory Installation (Form 102)
 - 6. Final Operation and Maintenance Manuals.
 - 7. Approved Performance Demonstration Plan
 - 8. Notification by Contractor of equipment readiness for testing.
- B. The Contract Administrator shall inform the Contractor at least fourteen (14) days in advance of conducting the tests and arrange for the attendance of the Contractor's representative. The tests may be concurrent with the inspection of satisfactory installation if mutually agreed by the Installation Contractor, Contractor, and the Contract Administrator.
- C. The Contractor shall conduct all necessary checks to equipment and if necessary, advise the Installation Contractor of any further checking, flushing, cleaning, or other remedial measures required to ensure satisfactory operation prior to confirming the equipment is ready to run.
- D. The Contractor shall then notify the Contract Administrator of his readiness to demonstrate the functional operation of the equipment. The Contract Administrator shall attend, as expeditiously as possible.

- E. With the assistance of the Contractor's representative, the Installation Contractor shall demonstrate that the equipment is properly installed. Alignment, piping connections, electrical connections, etc., shall be checked and if appropriate, code certifications provided.
- F. The equipment shall then be run for one (1) hour. Local controls shall be satisfactorily verified by cycling the equipment through several start-stop operations, modulating its output, or some combination. Operating parameters such as temperature, pressure, voltage, vibration, etc., shall be checked to ensure that they are within the specified or Contractor's recommended limits, whichever is more stringent.
- G. On satisfactory completion of the one (1) hour functional demonstration, the equipment shall be stopped and critical parameters and equipment systems shall be rechecked.
- H. Test the control system to confirm that it operates in accordance with the Contractor's process control narratives, including but not limited to:
 - 1. Confirm alarms are initiated by alarm conditions, are annunciated correctly, and are terminated in accordance with design requirements.
 - 2. Confirm shutdowns are initiated in response to emergency or serious adverse conditions.
 - 3. Test process control loops to confirm correct response of process equipment to changing conditions.
 - 4. Test manual operations.
 - 5. Test automatic operations.
 - 6. Test emergency operations.
 - 7. Test set point adjustments.
- I. The equipment shall then be run continuously for at least three (3) consecutive days to confirm integrated system operation. During this period, as practicable, conditions shall be simulated which represent the full range of operating conditions. These conditions shall be mutually agreed by the Contractor, the Installation Contractor, and the Contract Administrator on the basis of the information contained in the Specifications, as well as the methods utilized to create the simulated conditions and the time periods allotted to each. This testing shall include, but not be limited to:
 - 1. Take daily 24-h flow-proportional composite samples to measure HRC influent and effluent TSS concentrations.
 - 2. Measure Ballast loss.
 - 3. Record coagulant and polymer use.
 - 4. Operate each HRC train individually as well as all trains in parallel utilizing the automatic control logic to control the train switch-overs.
 - 5. Operate at least one (1) day at the guaranteed maximum coagulant and polymer doses.
- J. Should the functional testing reveal any defects, then those defects shall be promptly rectified and the functional tests shall be repeated to the satisfaction of the Contract Administrator. If the defects are attributed to the Contractor, additional costs to repeat functional tests incurred by the Installation Contractor, Contract Administrator, or the City shall be the responsibility of the Contractor.

- K. Equipment Test Reports: Provide written test reports for each item of equipment tested, to include the minimum information:
 - 1. Owner/Project Name.
 - 2. Equipment or item tested.
 - 3. Date and time of test.
 - 4. Type of test performed (Functional).
 - 5. Test conditions.
 - 6. Test results.
 - 7. Signature space for Contractor and Contract Administrator representatives.
- L. On successful completion of the functional tests, the Certificate of Equipment Satisfactory Performance (Form 103) attached to this Specification shall be signed by the Contractor's Representative, the Installation Contractor, and the Contract Administrator.
- M. Separate copies of Form 103 shall be furnished for each individual unit process item of equipment. In addition, furnish a copy of Form 103 for the entire system supplied under this Contract.
- N. When, in Contract Administrator's opinion, equipment meets functional requirements specified, such equipment will be accepted for purposes of advancing to performance testing phase.

3.8 PERFORMANCE VERIFICATION

- A. Equipment shall be subjected to a performance test in accordance with the Specifications. Performance testing shall not commence until equipment has been accepted by the Contract Administrator as having satisfied the functional test requirements.
- B. Performance tests shall be as specified in Section 46 43 80, High Rate Clarification System or as reasonably required by the Contract Administrator to prove adherence to the requirements listed in the Specification.
- C. The Contractor shall submit the results of the performance tests to the Contract Administrator, documented and summarized in the format specified in Section 46 43 80, High Rate Clarification System. The Contract Administrator reserves the right to request additional testing. No equipment shall be accepted and handed over to the City prior to the satisfactory completion of the performance test(s) and receipt of the test reports.
- D. Should the performance tests reveal any defects, then those defects shall be promptly rectified and the performance tests shall be repeated to the satisfaction of the Contract Administrator. If the defects are attributed to the Contractor, additional costs to repeat performance tests incurred by the Installation Contractor, Contract Administrator, or the City, shall be the responsibility of the Contractor.
- E. On successful completion of the performance tests, the Certificate of Satisfactory Process Performance (Form 104) attached to this Specification shall be signed by the Contractor's Representative, the Installation Contractor, and the Contract Administrator. Furnish one copy of Form 104 for the entire system supplied under this Contract.

- F. When, in Contract Administrator's opinion, equipment meets performance requirements specified, such equipment will be accepted as conforming to Contract requirements. Such acceptance will be evidenced by Contract Administrator's signature on Certificate of Satisfactory Process Performance (Form 104). Issuance of Form 104 shall initiate Total Performance.

3.9 TRAINING

- A. Contractor's representative shall provide classroom training sessions to City's operation and maintenance (O&M) staff.
- B. The training sessions shall last two (2) days each, and include both classroom and field training components. The training sessions shall be given twice, to allow the City's staff to attend either session. The training sessions shall be given during the three (3) week period preceding the start of the functional testing required for Form 103.
- C. Coordinate the training session(s) with the Contract Administrator.
- D. Prepare a draft handout taking the form of the relevant sections of the O&M Manual specified in Section 01 78 23, Operation and Maintenance Data supplemented with any other information needed to fully explain the equipment operation.
- E. Prepare a draft agenda outlining the content of the training sessions. Allow half an hour at the beginning of the first period for the Contract Administrator to provide a summary of the design intent relating to that equipment. Following the engineering design overview, provide (as a minimum) information covering major equipment operation, mechanical and instrumentation engineering.
- F. Submit the draft training materials and draft agenda to the Contract Administrator for review and comment. Revise as necessary for Contract Administrator's acceptance.
- G. Inform the Contract Administrator of any requirements for audio-visual aids five (5) Working Days before the training session.
- H. Upon obtaining the Contract Administrator's acceptance of the training materials, the Contractor shall provide ten (10) sets of training seminar materials in similar format to the O&M Manuals prior to the training session. In addition, the Contractor's Representative shall be responsible to document each training session with a detailed set of minutes.
- I. Pre-Recorded Training Sessions:
 - 1. As available, provide audio and video recording of typical prestartup and post-startup instruction sessions, including Contractor's representatives' hands-on equipment instruction and classroom sessions
 - 2. Use DVD format, suitable for playback on standard equipment available commercially in Canada.
 - 3. Include one typical training session on each DVD

- J. The Contractor shall be informed that the Contract Administrator may engage Others to record training sessions at the SEWPCC.
- K. Upon completion of training, the Contractor shall issue Certificate of Satisfactory Classroom Training (Form T-1) and Certificate of Satisfactory Field Training (Form T-2), complete with all required signatures.

3.10 SUPPLEMENTS

- A. The supplements listed below, following “End of Section”, are part of this Specification.
 - 1. Contractor’s Certificate of Compliance
 - 2. Unit Process Startup Form
 - 3. Certificate of Equipment Delivery (Form 100)
 - 4. Certificate of Readiness to Install (Form 101)
 - 5. Certificate of Satisfactory Installation (Form 102)
 - 6. Certificate of Equipment Satisfactory Performance (Form 103)
 - 7. Certificate of Satisfactory Process Performance (Form 104)
 - 8. Certificate of Satisfactory Classroom Training (Form T-1)
 - 9. Certificate of Satisfactory Field Training (Form T-2)
 - 10. Winnipeg Sewage Treatment Program Integrated Management System
Contractor Safety Health and Environment Plan

END OF SECTION

CONTRACTOR'S CERTIFICATE OF COMPLIANCE

CITY _____ PRODUCT, MATERIAL OR SERVICE
SUBMITTED: _____

PROJECT NAME: _____

PROJECT NO: _____

COMMENTS: _____

Comments: _____

I hereby certify that the above-referenced product, material, or service called for by the Contract for the named Project will be furnished in accordance with all applicable requirements. I further certify that the product, material, or service are of the quality specified and conform in all respects with the Contract requirements, and are in the quantity shown.

Date of Execution: _____, 20__

Contractor: _____

By Contractor's Authorized Representative (*print*): _____

(Authorized Signature)

UNIT PROCESS STARTUP FORM

OWNER: _____ **PROJECT:** _____

Unit Process Description: (Include description and equipment number of all equipment and devices):

Startup Procedure (Describe procedure for sequential startup and evaluation, including valves to be opened/closed, order of equipment startup, etc.):

Startup Requirements (Water, power, chemicals, etc.): _____

Evaluation Comments: _____



Water and Waste Department • Service des eaux et des déchets

Form 100
CERTIFICATE OF EQUIPMENT DELIVERY

We certify that the equipment listed below has been delivered into the care and custody of the Installation Contractor. The equipment has been found to be in satisfactory condition. There is no visible evidence of exterior damage or defects.

Project: SEWPCC Upgrading/Expansion Project
Equipment Description:
Equipment Supply Bid Opp. No.: 873-2013
Equipment Install Bid Opp. No.:
Equipment Tag No.:
Specification Reference:

Print Name Signature
(Authorized Representative of Contractor)

Date

Print Name Signature
(Authorized Representative of Installation Contractor)

Date

Print Name Signature
(Authorized Representative of Contract Administrator)

Date



Water and Waste Department • Service des eaux et des déchets

Form 101
CERTIFICATE OF READINESS TO INSTALL

We have familiarized the installing contractor of the specific requirements related to the equipment listed below and am satisfied that the installing contractor understands the required installation procedures.

Project: SEWPCC Upgrading/Expansion Project
Equipment Description:
Equipment Supply Bid Opp. No.: 873-2013
Equipment Install Bid Opp. No.:
Equipment Tag No.:
Specification Reference:

Print Name _____ Signature _____
(Authorized Representative of Contractor)

Date _____

We certify that we have received satisfactory installation instructions from the equipment manufacturer/vendor.

Print Name _____ Signature _____
(Authorized Representative of Installation Contractor)

Date _____



Water and Waste Department • Service des eaux et des déchets

Form 102
CERTIFICATE OF SATISFACTORY INSTALLATION

We have completed our checks and inspection of the installation of our equipment as listed below and confirm that it is satisfactory and that any defects have been remedied except any as noted below.

Project: SEWPCC Upgrading/Expansion Project
Equipment Description:
Equipment Supply Bid Opp. No.: 873-2013
Equipment Install Bid Opp. No.:
Equipment Tag No.:
Specification Reference:
Outstanding Defects:

Print Name _____ Signature _____
(Authorized Representative of Contractor)

Date _____

Print Name _____ Signature _____
(Authorized Representative of Installation Contractor)

Date _____



Water and Waste Department • Service des eaux et des déchets

Form 103

CERTIFICATE OF EQUIPMENT SATISFACTORY PERFORMANCE

We certify that the equipment listed below has been continuously operated for a minimum of three (3) consecutive days and that the equipment operates satisfactorily and meets its specified operating criteria. No defects in the equipment were found and as such are classified as "conforming".

Project: SEWPCC Upgrading/Expansion Project
Equipment Description:
Equipment Supply Bid Opp. No.: 873-2013
Equipment Install Bid Opp. No.:
Equipment Tag No.:
Specification Reference:

Print Name _____ Signature _____
(Authorized representative of Contractor)

Date _____

Print Name _____ Signature _____
(Authorized representative of Installation Contractor)

Date _____

Print Name _____ Signature _____
(Authorized representative of Contract Administrator)

Date _____



Water and Waste Department • Service des eaux et des déchets

Form 104
CERTIFICATE OF SATISFACTORY PROCESS PERFORMANCE

We certify that the process system listed below has been continuously operated and tested as per the Specifications using process fluid and that the equipment meets its Performance Testing and Operating Criteria. No defects in the process system were found and as such are classified as “conforming”.

Project: SEWPCC Upgrading/Expansion Project
Equipment Description:
Equipment Supply Bid Opp. No.: 873-2013
Equipment Install Bid Opp. No.:
Equipment Tag No.:
Specification Reference:

| | | |
|---|-----------|------|
| Print Name (Authorized Representative of Contractor) | Signature | Date |
|---|-----------|------|

| | | |
|--|-----------|------|
| Print Name (Authorized Representative of Installation Contractor) | Signature | Date |
|--|-----------|------|

| | | |
|--|-----------|------|
| Print Name (Authorized Representative of Contract Administrator i.e. Commissioning Lead or Design Discipline Lead) | Signature | Date |
|--|-----------|------|

| | | |
|---|-----------|------|
| Print Name (Authorized Representative of City) | Signature | Date |
|---|-----------|------|



Water and Waste Department • Service des eaux et des déchets

Form T-1
CERTIFICATE OF SATISFACTORY CLASSROOM TRAINING

We have completed classroom training in the operation and maintenance of the equipment as listed below.

Project: SEWPCC Upgrading/Expansion Project

Equipment Description:

Equipment Supply Bid Opp. No.: 873-2013

Equipment Install Bid Opp. No.:

Equipment Tag No.:

Specification Reference:

List of Attendees:

Print Name
(Trainer)

Signature

Date

Print Name
(Authorized Representative of Contract Administrator)

Signature

Date

Print Name
(Authorized Representative of City)

Signature

Date



Water and Waste Department • Service des eaux et des déchets

Form T-2
CERTIFICATE OF SATISFACTORY FIELD TRAINING

We have completed field training in the operation and maintenance of our equipment as listed below.

Project: SEWPCC Upgrading/Expansion Project

Equipment Description:

Equipment Supply Bid Opp. No.: 873-2013

Equipment Install Bid Opp. No.:

Equipment Tag No.:

Specification Reference:

List of Attendees:

Print Name
(Trainer)

Signature

Date

Print Name
(Authorized Representative of Contract Administrator)

Signature

Date

Print Name
(Authorized Representative of City)

Signature

Date

Winnipeg Sewage Treatment Program Integrated Management System



Contractor Safety Health and Environment Orientation Plan

DOCUMENT NUMBER: CD-PM-PC-03

| Rev | Prepared by | Reviewed by | Date | Approved by | Date |
|-----|--------------|-------------|----------|-------------|------|
| | B. Willemsen | | 13/07/25 | | |
| | | | | | |
| | | | | | |
| | | | | | |
| | | | | | |

Table of Contents

| | |
|--|----------|
| 1. Introduction | 3 |
| 2. Site Orientations | 3 |
| 2.1 General..... | 3 |
| 2.2 Hazards | 3 |
| 2.3 Personal Protective Equipment (PPE)..... | 4 |
| 2.4 Codes of Practice | 4 |
| 2.5 Safety Equipment | 5 |
| 2.6 Emergency Procedures | 5 |
| 2.7 Access Control | 5 |
| 2.8 Permitting | 5 |
| 2.9 Environmental..... | 5 |
| 2.10 Definitions..... | 6 |

1. INTRODUCTION

The Contractor Safety, Health and Environment Orientation Plan shall be regarded as the minimum standard that all contractors and their employees must be oriented with, prior to working on a WSTP project site.

The purpose of the Contractor Safety, Health and Environment Orientation Plan is to:

- (a) Present an overview of the facilities and its known hazards;
- (b) Identify environmental preservation and compliance requirements; and
- (c) Provide relevant safe work procedures for existing plant works.

The Contractor Safety, Health and Environment Orientation Plan will be reviewed by the WSTP Program Team at least annually to adjust for changing conditions

Contractors have the same obligations to their employees as any other employer in Manitoba. Where safety issues arise concerning contractor employees a safety concern will always be taken to the supervisor of the employees involved.

It is the right of the City of Winnipeg to require the contractor to resolve any safety issue raised to the City's satisfaction before work continues. This decision belongs to the city's Project Manager responsible for the project with support from any safety resource needed.¹

Contractors can review the City of Winnipeg Workplace Safety & Health Program for Contractors at <http://winnipeg.ca/matmgt/Safety/>

2. SITE ORIENTATIONS

2.1 General

Before contract work begins, site specific known hazards and controls, safe work and emergency procedures, access control and reporting requirements will be communicated as minimum requirements to the contractor and his employees by plant operations or contract administrators in consultation with departmental safety resources as needed.

In addition, contractors working within the plant shall undergo a Safety Walkthrough of applicable plant areas with designated Plant Operations personnel to receive area specific safety orientation. The purpose of the walkthrough is to familiarize the workers with hazards specific to the work area.

All contractor employees must sign-off acknowledging receipt and understanding of orientation information provided by City of Winnipeg Water and Waste Department.

2.2 Hazards

Contractors and their employees must become familiar with hazards in the plant areas they are working in and in addition shall complete their own risk assessments prior to undertaking the work.

The following listing although not exhaustive identifies hazards that contractors can expect to encounter while performing works within the wastewater treatment plants. Contractors and their employees must observe and obey all signage posted within the wastewater treatment plant.

¹ Organizational Safety Code of Practice COW

- (a) Open Tank areas- be aware of potential for slips , trips and falls due to wash down hoses or wet floors, know where the life safety floatation devices are located;
- (b) Automatic Controls- be aware that equipment can start and stop automatically and as such stay clear of equipment;
- (c) Excessive Noise-be aware of areas within the plant that have the potential to generate loud noise necessitating the use of hearing protection;
- (d) Hazardous Atmospheres-fixed gas detectors with strobe lights are mounted in various areas of the plant. Contractors shall also monitor for H2S & LEL gases through use of personal detectors in these designated areas and confined spaces. If detectors or strobe lights go into alarm, contractors shall leave the area, notify the lead operator of the alarm and obtain clearance from the lead operator prior to re-entry into the work area;
- (e) Biological Hazards- Personal Hygiene through frequent hand washing after working in process areas will help prevent spread of germs. Minor cuts and scrapes should be attended to immediately to prevent infection from occurring. Do not drink water from hoses or taps in the plant;
- (f) Confined Spaces-Be aware of the locations of confined spaces within the plant;
- (g) Arc Flash- be aware of the location of high voltage equipment;
- (h) Working from Heights- be aware of fall protection requirements when working above stipulated heights; and
- (i) Hazardous Materials- be aware of WHMIS relative to the worksite.

2.3 Personal Protective Equipment (PPE)

The following PPE minimum requirements shall be adhered to by contractors when working at the wastewater treatment plants.

- (a) Approved safety footwear;
- (b) Safety Glasses;
- (c) Hard Hats;
- (d) High Visibility vests;
- (e) Hearing Protection in designated areas; and
- (f) Personal locks for Lockout Tag out of equipment.

2.4 Codes of Practice

Contractors shall comply with The Workplace Safety and Health Act W210 , Manitoba Regulations 217/2006 and utilize the following Codes of Practice and Guidelines as minimum requirements. It is Contractors responsibility to ensure the most recent Code of Practice or Guideline is being utilized.

- (a) [Code of Practice for Confined Space Entry](#) (Nov 2006).
- (b) [Guideline for Fall Protection](#) (July 2008).
- (c) [Water and Waste Department Lockout Tag Out Procedure](#)

2.5 Safety Equipment

Contractors shall provide their own critical safety equipment including but not limited to: personal LEL detectors, self-retracting lanyards, portable man hoists, fire extinguishers, portable eyewash units, first aid kits etc. Use of City owned safety equipment by contractor personnel is not permitted.

2.6 Emergency Procedures

Contractors working within the plant must have emergency procedures in place to deal with situations that could arise as a result of their own work activities. Lists containing the names and contact numbers of project and emergency respondents should be conspicuously posted around the work areas.

Contractors working within the plant's various areas shall take note of where the emergency exit locations are located. If and when a Fire Alarm sounds, immediately evacuate to a designated muster point. The Contractor is accountable for his own staff and must report to the Wastewater Treatment Plant's Chief Fire Warden with confirmation that Contractor workers have vacated the plant..

2.7 Access Control

Access to the work site will be the designated plant entry point door identified during the orientation.

The Contractor will take all steps reasonable to ensure that any visitor to the construction site receives appropriate orientation and supervision to ensure that they are not put at risk.

2.8 Permitting

Control of construction and installation work at an operating plant requires clear, concise and documented communication among contractors, contract administrators and plant operators. Contractors shall prepare and utilize the following permits as applicable and obtain necessary sign-offs prior to undertaking the associated work.

- (a) Hot Work permit; and
- (b) Confined Space Entry permit.

The above listed Permit templates, when required, will be provided to Contractor during the site orientation.

2.9 Environmental

The Worksite is part of the City of Winnipeg Wastewater System. Safe handling and storage of fuel, oils, and chemicals shall be of the highest priority and care. Contractors shall review and understand the City of Winnipeg [Environmental Management Policy](#), associated Preservation and Compliance documentation and [CD-PM-TO-52 Environmental Accident Reporting Regulation](#). Any spill or release shall be immediately reported to the Contract Administrator.

The Contract Administrator shall immediately notify the City of such spills in accordance with established City of Winnipeg protocols and monitor the Contractors containment and remediation actions. The Contract Administrator shall obtain copies of Contractors incident report and investigation.

2.10 Definitions

City of Winnipeg

Refers to The City of Winnipeg, as continued under, The City of Winnipeg Act, Statutes of Manitoba 1989-90, C-10, and any subsequent amendments thereto.

H2S Hydrogen Sulfide

LEL Lower Explosive Limit

LOTO Lockout Tag Out Procedure

PPE – Personal Protective Equipment

To be worn at all times while on the worksite or adjacent areas where work is being undertaken.

WSTP Program Team

Team comprised of both Veolia and City of Winnipeg personnel

Project

The location or locations at which the Work is to be performed, including rights of way, leases and temporary working spaces, and in Definitions (Act W.210), page 2.

Workplace Safety and Health Act W.210, MR217/2006

Governing Health and Safety in the province of Manitoba or those regulations that are in effect at the time of the work.

WSTP Winnipeg Sewage Treatment Program

MANITOBA LABOUR AND IMMIGRATION
WORKPLACE SAFETY AND HEALTH

Code of Practice

For Confined Space Entry Work



**SAFE
WORK**

S SPOT THE HAZARD
A ASSESS THE RISK
F FIND A SAFER WAY
E EVERYDAY

Manitoba 

Code of Practice

For Confined Space Entry Work

November, 2006



TABLE OF CONTENTS

| | |
|---|-----------|
| Introduction | 3 |
| Definition..... | 5 |
| Hazards - Potential for Fatality..... | 6 |
| Section A - Some Examples of Confined Space..... | 7 |
| Section B - Hazard/Risk Identification - Considerations..... | 14 |
| Section C - Hazard Assessment in Confined Spaces | 15 |
| Section D - Safe Work Practices and Procedures | 21 |
| Appendix "A" | 31 |
| Appendix "B" | 32 |
| Appendix "C" | 34 |

INTRODUCTION

Preventing Confined Space Accidents

The Workplace Safety and Health Act, in part, states that it is the employer's responsibility to provide workers with information, instruction, training, supervision and facilities to ensure the workers' safety, health and welfare.

Refer to Part 15 of Manitoba Regulation 217/2006 for detailed regulatory requirements.

This Code of Practice provides employers with practical guidance on how to fulfill their obligations to protect the safety and health of workers where there is a requirement or permit for workers to enter into a confined space.

Acknowledgement:

Some of the material contained in this publication is courtesy of the Industrial Accident Prevention Association, Construction Safety Association of Ontario, and Workers' Compensation Board of British Columbia.

**Manitoba Labour and Immigration
Workplace Safety and Health Division
Room 200-401 York Avenue
Winnipeg, Manitoba
R3C 0P8**

Printed 2006

INTRODUCTION

Every year people die in confined spaces. In many of these cases, the result is multiple fatalities. For confined space entry work, there is a need to:

1. **Spot the hazard:** Identify confined spaces where workers may have to enter to work.
2. **Asses the risk:** Train workers to identify and assess hazards before they are exposed to them.
3. **Find a safer way:** Reduce, control, or eliminate hazards and find safer working methods.

You can work safely in a confined space if you make proper hazard / risk assessments and implement safe work procedures.

This Code of Practice will:

- Help in recognizing confined spaces
- Help in developing safe work practices and procedures for confined space entry
- Supplement the employer's regular training program for workers required to enter and work in confined spaces
- Help members of workplace safety and health committees in identifying and making recommendations on hazard assessment and control.

Always consider confined spaces to be immediately dangerous to life and health (**IDLH**) until hazard assessment is complete and control measures are in place.

DEFINITION

M.R. 217/ 2006 – Sec. 15

Confined space means an enclosed or partially enclosed space that:

- (a) except for the purpose of performing work, is not primarily designed nor intended for human occupancy
- (b) has restricted means of access or egress
- (c) is or may become hazardous to a worker entering it (within it) because of:
 - (i) its design, construction or atmosphere
 - (ii) the materials or substances in it
 - (iii) the work activities to be performed in it or processes used in it, or
 - (iv) any other conditions or hazards relating to it

For the purposes of this code of practice, **hazard/risk assessment** refers to the process of identifying ways in which a worker may suffer harm while in a confined space.

As a general requirement, employers must identify and take measures to reduce, control or eliminate hazards associated with confined spaces including:

- (i) doing the work in a way that will not require a worker to enter the space
- (ii) changing the physical characteristics of the confined space to ensure safe entry and exit

CONFINED SPACE HAZARDS – POTENTIAL FOR FATALITY

- Entering a tank without testing
- Entering a confined space and not ventilating it
- Using an inert gas to force a liquid out of a tank
- Using welding hoses and valves without periodically checking for leaks
- Using oxygen to ventilate confined spaces
- Not investigating the effects of stirring up sludge in a confined space
- Not using proper respiratory protection
- Not checking processes in the vicinity of the space for possible release of toxic or flammable substances
- Welding in a tank without checking neighbouring compartments
- Not blanking out, locking out
- Leaving a space that has been tested safe for entry and re-entering it later without retesting it
- Improper rescue procedures

SECTION A
EXAMPLES OF A CONFINED SPACE

Storage tanks — Installations Above or Below Ground, Rail Tanks, Truck Tanks

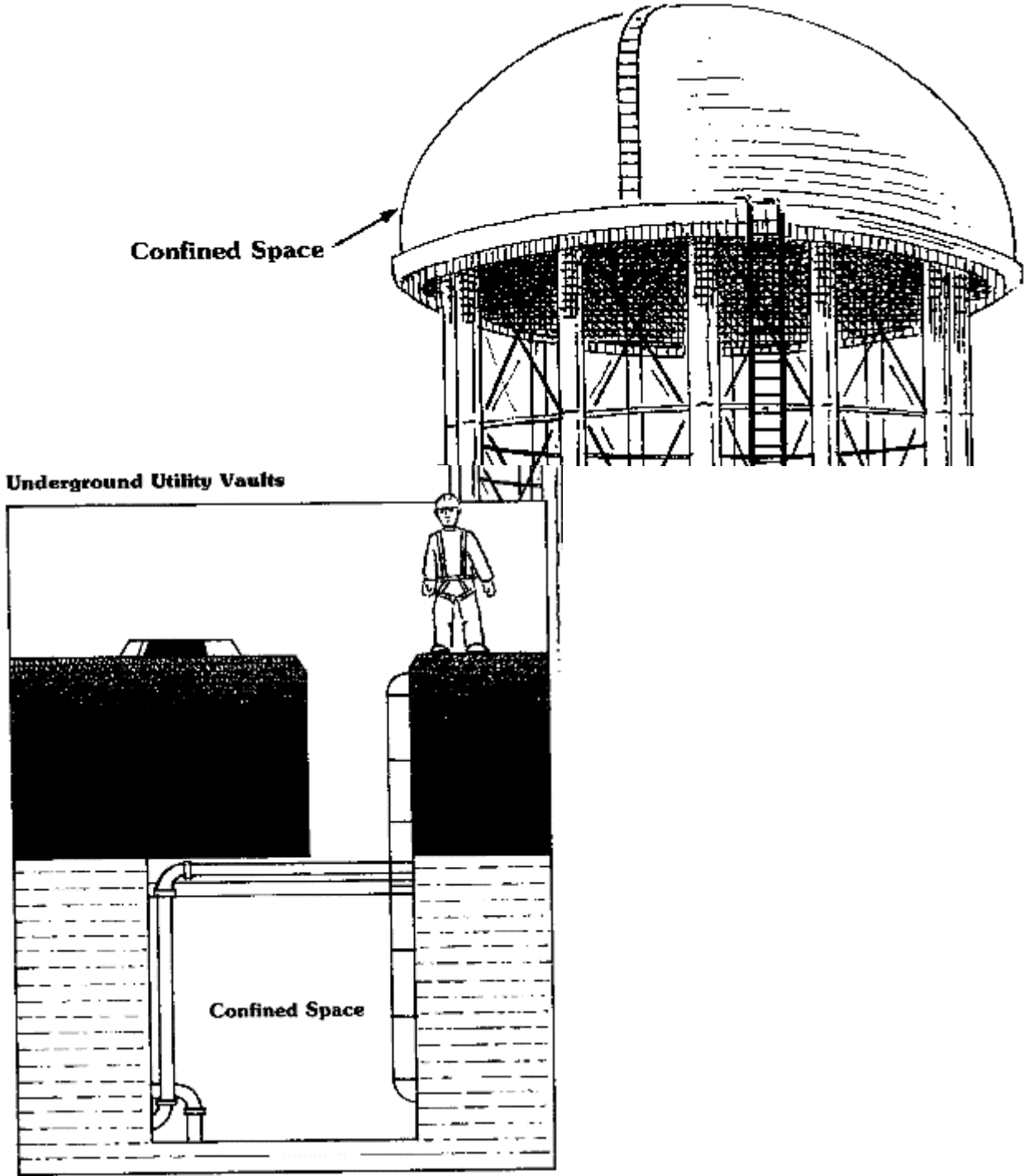

Tunnel and Pipelines

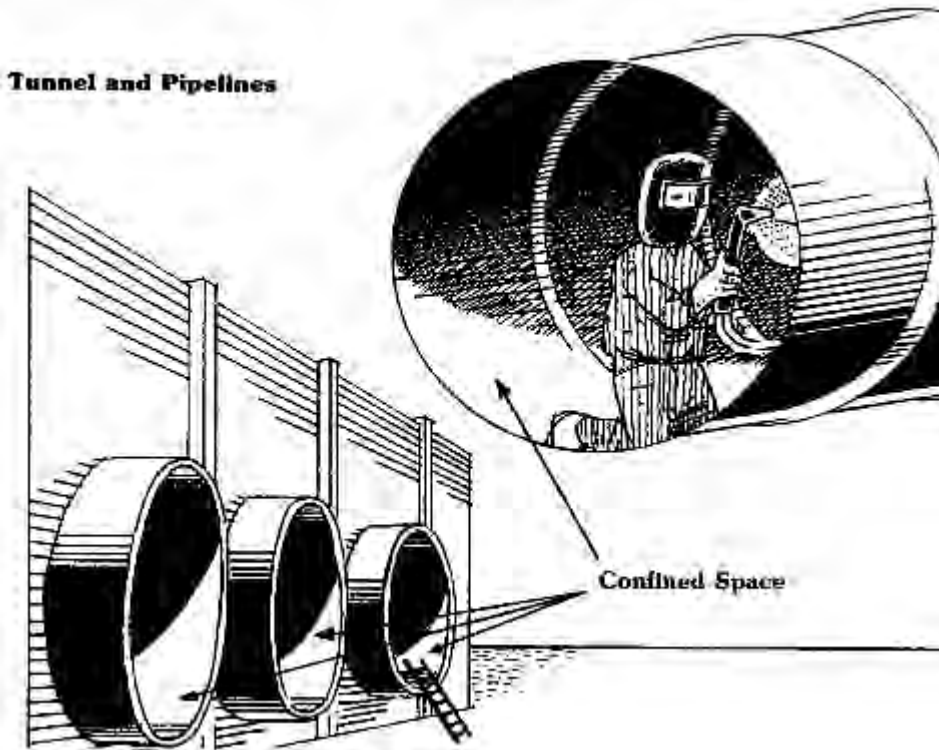

Caissons

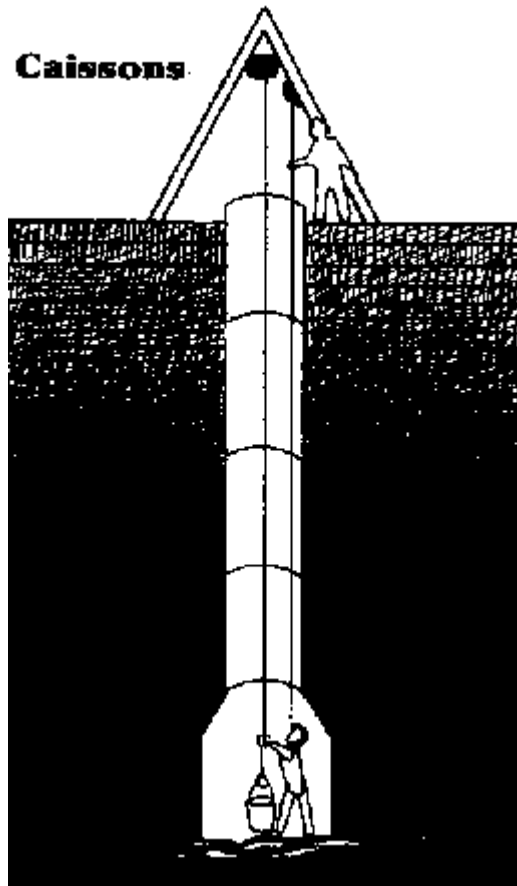

Holds, Ballast Tanks of Barges and Ships

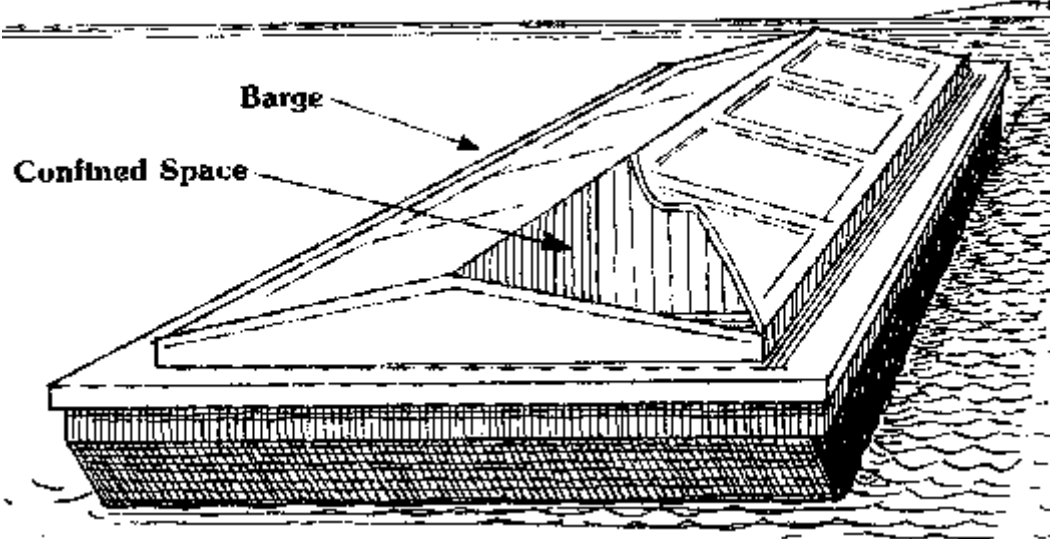

Ventilation Ducts, Reactors and Process Vessels

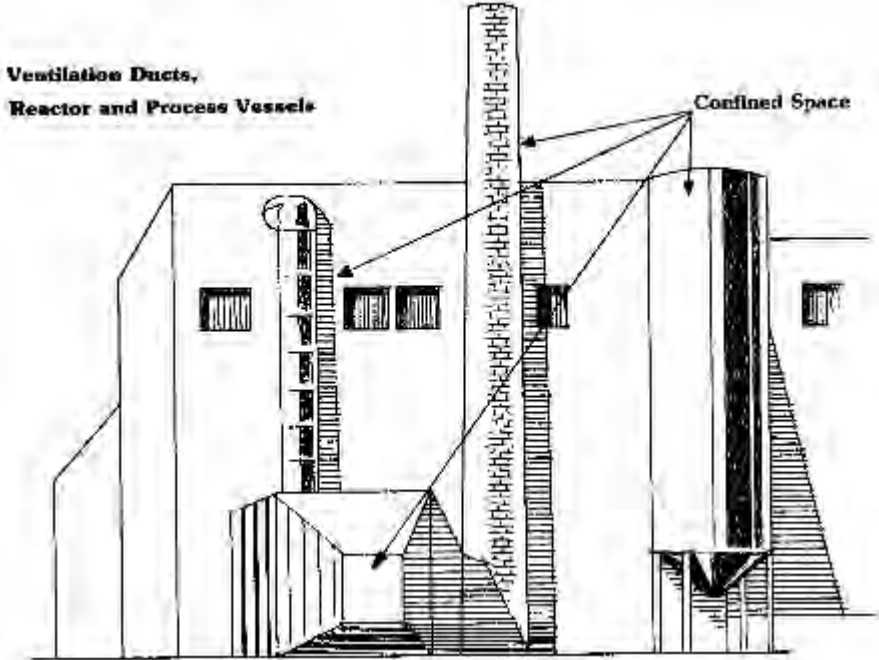

Machinery and Equipment

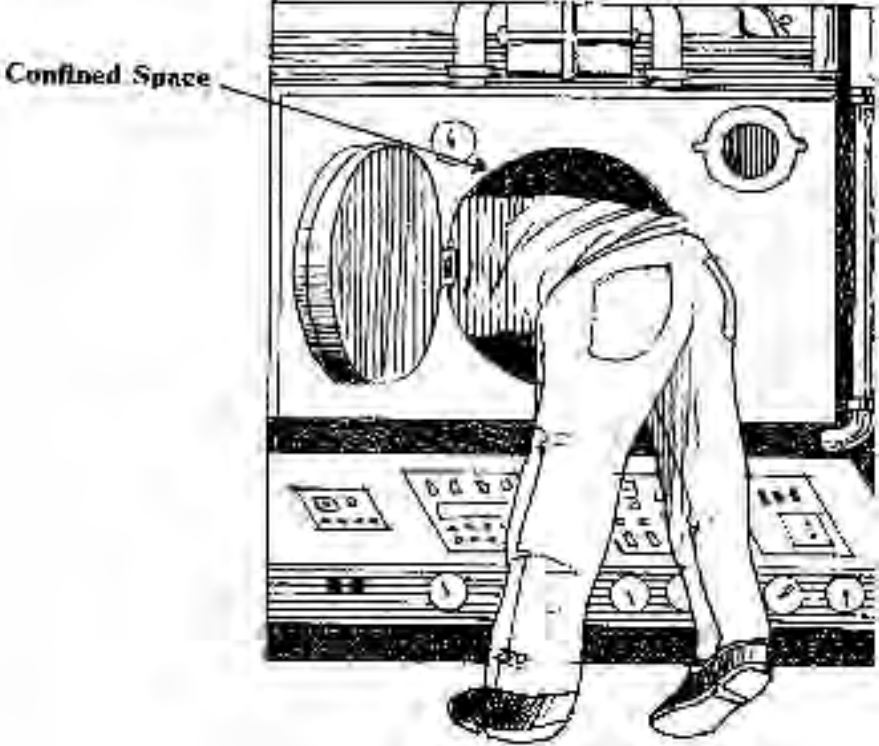
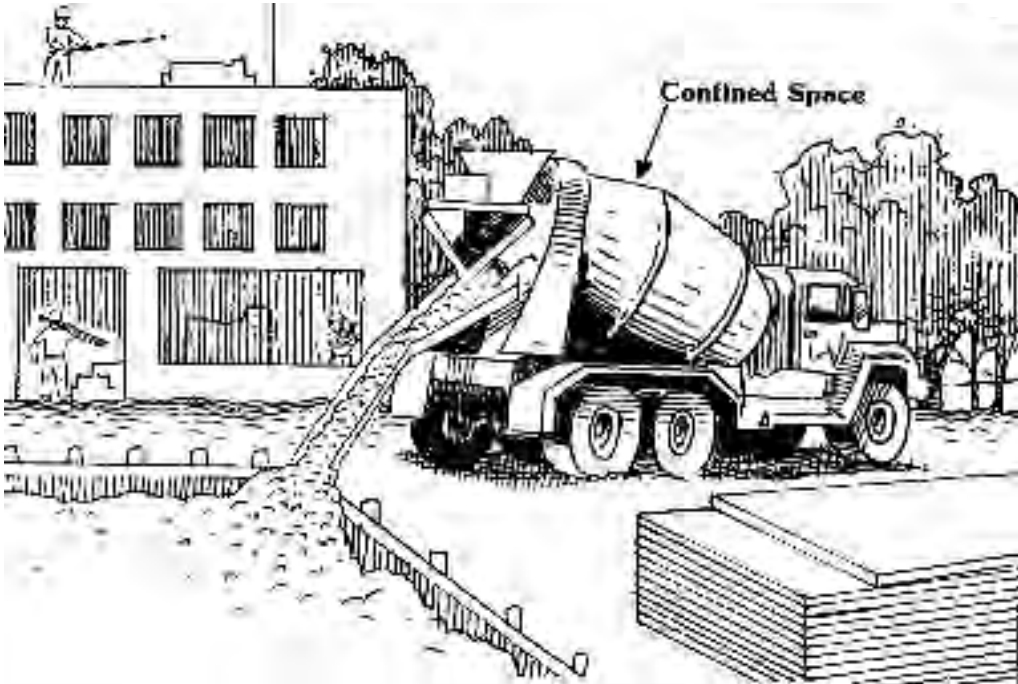

Manure Pits, Well Pits

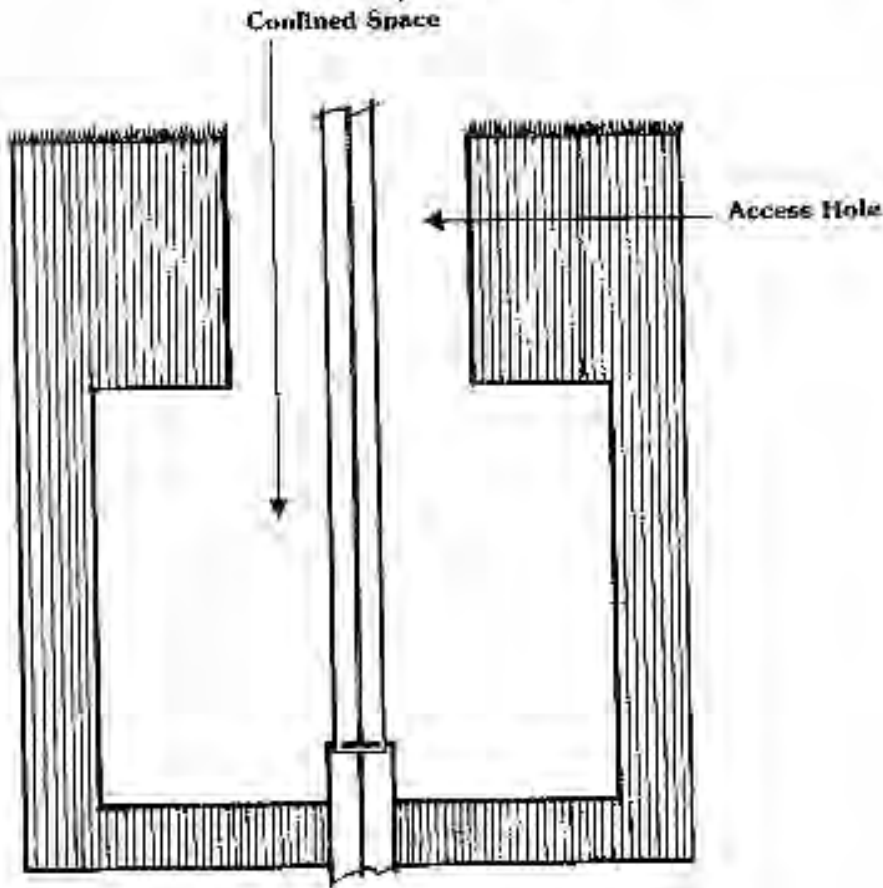
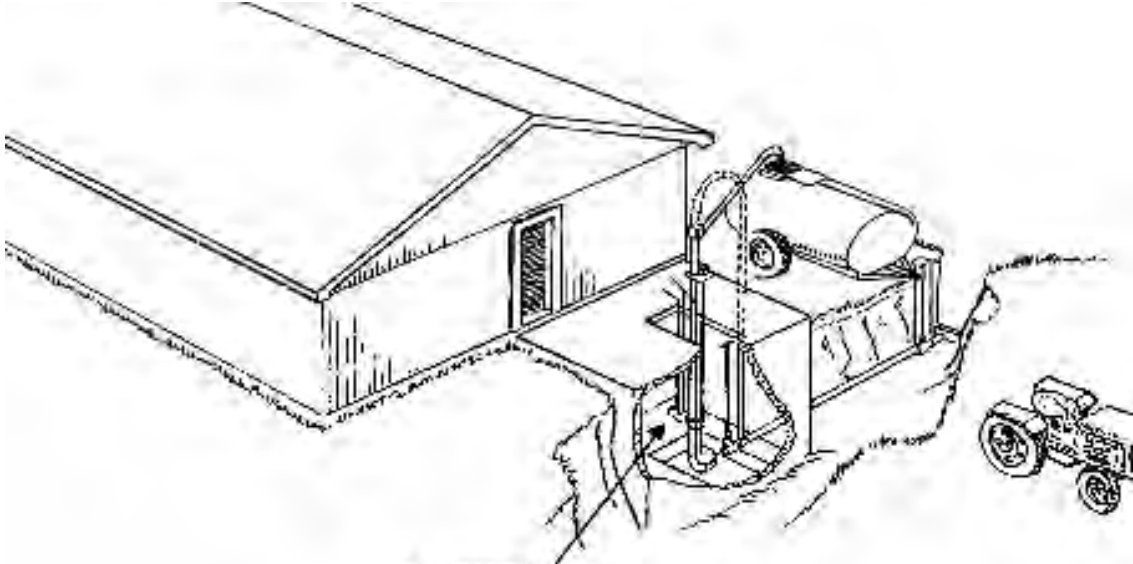

Sewage Handling Systems

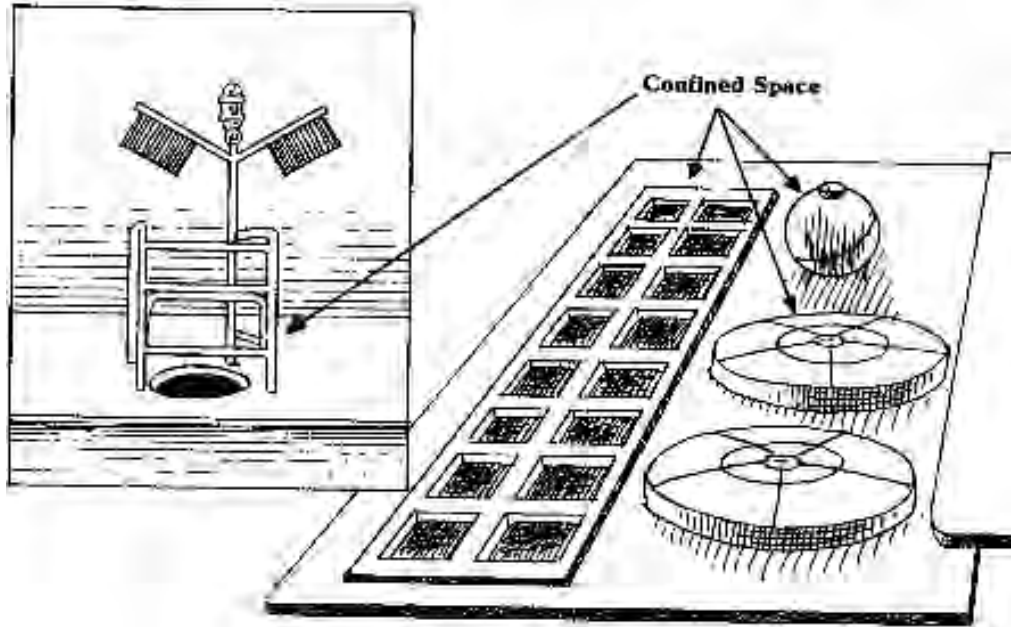

Silos, Grain Bins, Hoppers

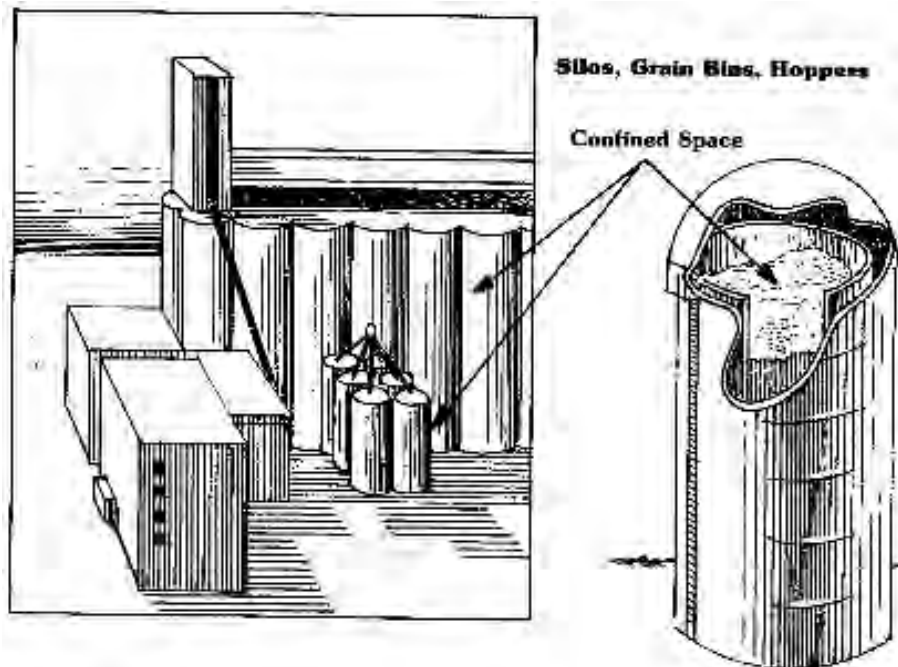

It is recommended that employers identify and record confined space work areas at their workplaces.

A confined space work area recording sheet is provided in Appendix A to assist with the following:

- a) identification of confined spaces
- b) identification and assessment of potential hazards and risks
- c) development of required safe work practices and procedures

Example #1:

A fuel storage tank 40 metres in diameter, and 15 metres high, with a ground level side hatch for access, requires cleaning and repair of the heater coil.

| Confined Space | Hazards | Precautions |
|-------------------|----------------------|---|
| fuel storage tank | explosive atmosphere | use continuous explosive gas monitoring |
| | oxygen deficiency | oxygen monitoring/ventilation |
| | welding | hot work permit |
| | access/egress | emergency rescue provisions |
| | fluids entering tank | blanking off lines and locking off valves |

Example #2

| | | |
|---------|------------------------------------|--|
| manhole | explosive gases | continuous explosive gas monitoring |
| | oxygen levels | oxygen monitoring |
| | unknown toxic gases | supplied air breathing apparatus |
| | residual chemicals on sewer pipe | supplied air and continuous explosive monitoring |
| | chemicals in effluent (live sewer) | supplied air, explosive gas monitoring and full skin (dermal) protection |
| | micro organisms | supplied air, personal hygiene and immunizations (occupational health service) |
| | access/egress | hoisting/retrieving system and harness and lifeline; standby worker equipped with supplied air and emergency rescue provisions, third worker present |
| | slippery rungs, surfaces | footwear and traction/grip, hoisting/retrieval system. harness, lifeline and standby worker equipped |

SECTION B

HAZARD/RISK IDENTIFICATION - CONSIDERATIONS

A) Atmospheric (within the confined space)

- Explosive gases/vapours
- Toxic gases/vapours
- Oxygen content
 - deficiency
 - enrichment
- Fumes, dusts, mists, fogs
- Smoke
- Biological agents

B) Safety hazards

- Entry/exit
- Ventilation systems
- Machinery
- Piping/distribution systems
- Residual chemicals/materials
- Electrical
- Visibility
- Physical obstacles
- Walking/working surfaces
- Temperature extremes
- Humidity
- Noise
- Vibration
- Radiation
- Hazardous animals

C) Work to be performed

- Hot work/cold work

D) Human factors

- Phobias
- Mental and physical condition of workers

SECTION C

HAZARD ASSESSMENT (cont'd)

| Hazard | Explanatory Notes | Methods of Test | Effects of Hazard | Examples |
|--|---|---|--|---|
| A. Atmosphere | | | | |
| 1. Explosive Atmosphere | Before entering a confined space, tests for presence of an explosive atmosphere must be done. It should be noted that air-borne dust from grain, fine ground metals or other materials can form an explosive atmosphere. Explosive gases may displace oxygen. Note: Oxygen enrichment or deficiency can cause error in combustible gas detector readings. | Use a combustible gas detector. Monitor explosive gases by using equipment that can detect the lower explosive limit (LEL) and upper explosive limit (UEL). Residuals may have to be disturbed to allow the release of explosive gases. | Explosion, burns, multiple injuries, death | 1. Methane (natural gas) CH ₄ sources: gas line leaks, decaying matter. May be found adjacent to land fill sites, backed up or sluggish sewers. 2. Gasoline and other solvents: storage tanks and adjacent areas, sewer systems proximity to pipelines, accidental spills. May have definite odour. |
| 2. Oxygen a) Deficiency | Deficiency - acceptable breathing air contains between 19.5 per cent and 23 per cent oxygen. Air containing less than 19.5 per cent of oxygen by volume is a hazardous atmosphere. | Oxygen detection monitor. | Could result in slowing down of pulse rate, disorientation, unconsciousness, and death. | Oxygen (O ₂) deficiency can occur when it is displaced by other gases, or by biological or chemical reactions, such as rusting or burning. |
| b) Enrichment | Enrichment means an atmosphere where the oxygen content is greater than 23 per cent by volume. Oxygen enrichment can cause an error in explosive meter readings | Oxygen detection meter. Note: Some equipment is not capable of detecting oxygen enrichment. | This creates an explosive atmosphere and increases rates of chemical reactions. If the oxygen content can not be reduced to less than 23 per cent, do not allow entry. | Enrichment may occur through the improper blanking of oxygen lines, leaking fuel gas welding equipment or ventilation with oxygen instead of air |
| 3. Toxic Gases, Vapour | To create and maintain a safe environment, appropriate detection equipment must be used to determine the presence of toxic gases. | Monitors: specific testers must be used for specific toxic gases, ex: H ₂ S monitoring. It may be necessary to disturb residue or sludge to allow release of toxic gases and vapours. | Can cause euphoria, disorientation, drowsiness, headaches, weakness, injury, disability and death. | 1. Carbon monoxide (CO) is colourless, odourless, tasteless and extremely poisonous. The most common sources of CO are poorly adjusted and maintained combustion devices. |

HAZARD ASSESSMENT (cont'd)

| Hazard | Explanatory Notes | Methods of Test | Effects of Hazard | Examples |
|-------------------------------------|---|--|---|--|
| A. Atmosphere | | | | |
| | | | | <p>2. Carbon dioxide (CO₂) is odourless. It is a heavy gas that concentrates at lowest levels. It displaces oxygen and does not diffuse or mix readily with air.</p> <p>3. Nitrogen dioxide (NO₂): a pungent, acrid odour, a product of gasoline and diesel engines.</p> <p>4. Hydrogen sulphide (H₂S) is a deadly gas commonly found in sewers and manure pits. It is produced by decomposing organic matter. It has a typical rotten egg odour, but high levels can shut down the sense of smell.</p> |
| 4. Fumes, Dusts, Mists, Fogs | These hazards can often be seen. | Use specific monitors or testers for each fume, dust, mist or fog. | Explosion, disability, injury, burns, irritation, poisoning and death | <p>1. Fumes: from asphalt, welding, acid fumes from washing processes.</p> <p>2. Dust: grain dust, sandblasting (silica)</p> <p>3. Mist: spraying applications</p> |
| 5. Smoke | Smoke is a combination of gases, vapours, fumes and dusts | Can be seen. Use appropriate detection and monitoring equipment to determine presence of toxic agents. | All effects of gases, dusts, vapours, mists, fumes | Result of combustion, ex: burning materials, smoke from welding |
| 6. Biological Agents | Biological agents are found in a variety of locations. Take extreme care when working near health care facilities or industrial processes using biological agents. Conscientious personal hygiene is essential. | Testing for presence of biological agents is very difficult. If you know the type of agent, then perform the specific testing. | Ill health, disease, disorders, irritation and death. | 1. Bacterial and viral infections. |

HAZARD ASSESSMENT (cont'd)

| Hazard | Explanatory Notes | Methods of Test | Effects of Hazard | Examples |
|--|---|---|--|---|
| B. Safety Hazard | | | | |
| 1. Entry/Exit (Access/Egress) | Openings that are small, narrow or otherwise difficult to negotiate can be a serious hazard. When using self-contained breathing apparatus, openings must be of a size to allow worker with equipment properly worn to pass through. Access openings less than 700 millimetres (28 inches) are not recommended. | Visual identification of obstructions that could interfere with normal movement or emergency rescue. | Injury, disability, and death | <ol style="list-style-type: none"> 1. exits at height that could cause falls 2. constricted openings 3. angled openings 4. exits into traffic and machinery 5. exits at deep depths |
| 2. Ventilation Systems | Lack of adequate ventilation may cause a build-up of contaminants. Ventilation systems can introduce hazards into the work area, ex: carbon monoxide (CO) fumes. | Monitoring (anemometer, smoke tubes for air movement). Toxic monitors may also be necessary to ensure good quality air. | Explosion, disease, irritation, injury, disability and death | Improper ventilation can result in: <ol style="list-style-type: none"> 1. oxygen level variations, 2. build up of toxic gases, vapours, dusts, mists, fumes smoke. 3. introduction of biological agents, toxic gases, explosive gases. |
| 3. Machinery/Mechanical Equipment | Make sure equipment is immobilized (de-energized) so that it will not be a hazard to workers. | Visual and function testing | Injury, disability and death | Drive belts, augers, paddles, scrapers, agitators and pumps |
| 4. Piping/Distribution Systems | Contents of pipes and supply lines, if allowed to enter a confined space can create a life threatening situation for workers. | Monitoring, visual | Chemical poisoning, drowning, burns, injury, disability, death | Steam lines, liquid distribution lines, feed mills and cement plants |
| 5. Residual Chemicals/materials | 1. Residual corrosive or toxic chemicals. Ensure all lines, valves, and meters are completely drained and properly decontaminated. | Monitoring | Injury, disability, death, explosion | Storage tanks, digesters, liquid distribution systems, augers. |

HAZARD ASSESSMENT (cont'd)

| Hazard | Explanatory Notes | Methods of Test | Effects of Hazard | Examples |
|------------------------------------|--|---|--|--|
| B. Safety Hazard | | | | |
| | 2. Material that may be adhered to surfaces/walls of enclosures may collapse. 3. Loose granular material that may engulf worker. 4. Material that may encapsulate/trap other toxic/explosive materials. 5. Flooding by liquids. | Visual, monitoring | Engulfment, suffocation - drowning, injury, disability, death. | 1. Silos, grain hoppers, fertilizer storage. 2. Sand, grains (ex: flax) 3. Rust build up of hydrogen sulphide (H ₂ S) 4. Flooding in underground facilities. |
| 6. Electrical | Unguarded electrical equipment. Take extreme caution when using conductive material around electrical surfaces (ex: metal ladders, lifelines, steel bars) | Testing conducted only by qualified personnel | Electrical shock, burns, injury, disability and death | 1. Underground electrical vaults and electrical distribution systems. 2. Motor control centres. |
| 7. Poor Visibility | Poor lighting, obstructions, work process and procedure, fog/mist due to high humidity. | Visual | Injury, disability and death | Improper/inadequate lighting, poor design of confined space, work process. |
| 8. Physical Obstacles | This would include obstacles that impede movement and performance of work and rescue procedures. | Visual | Inability to remove injured worker, contusions, abrasions, fractures, disability, injury, death. | Cross bracing, baffle plates, piping. |
| 9. Walking/Working Surfaces | Surfaces that are irregular in shape, sloped, angled, elevated, slippery, or obstructed are slip and fall hazards. Work areas may require toe boards to prevent objects from falling on workers below. | Visual | Injury, disability, and death | 1. Lift stations, aqueducts, dams 2. Work areas that require toe boards to prevent objects from falling on workers below. |

HAZARD ASSESSMENT (cont'd)

| Hazard | Explanatory Notes | Methods of Test | Effects of Hazard | Examples |
|---------------------------------|---|---|--|---|
| B. Safety Hazard | | | | |
| 10. Temperature Extremes | Temperature extremes have definite health and safety hazards, as well as having a limiting effect on the ability of a worker to perform tasks adequately. | Thermometer, heat stress, wet bulb globe thermometer (WBGT) | 1. Frost bite, loss of co-ordination, hypothermia, disability, death. 2. Heat exhaustion, heat stress, disorientation, death. | 1. Working in freezers, extreme cold climate conditions. 2. Working in boilers, super-heated areas (cooling towers), and areas with steam/heat distribution pipes. |
| 11. Humidity | High humidity can aggravate several conditions: 1. Visibility 2. Can cause all types of surfaces to become slippery. 3. Accelerates heat loss. 4. Increases chill effect. | Hygrometer | Such conditions can cause slips, falls, physical discomfort, heat exhaustion, affect performance of tasks. | 1. Boiler rooms 2. Digesters 3. Freezers |
| 12. Noise | If sound levels exceed 80 decibels, then work practices shall conform to requirements of current regulations respecting hearing conservation and noise control in workplaces. | Sound level meters | Distraction, stress, disorientation, communication problems, hearing loss. | Sources include operating equipment, such as jack hammers, pumps, grinders, other work procedures. |
| 13. Vibration | Whole body vibration can affect and place stress on multiple body parts/organs. | Vibration meter | White finger disease, disorientation, vertigo, circulation and nervous system disorders. | 1. Jack hammers, impact hammers/drills, and shakers. |
| 14. Radiation | 1. Non-ionizing radiation - ultraviolet light, infrared light components or sunlight. | 1. Non-ionizing - specific light meters. | 1. Non-ionizing topical burns. | 1. Ultraviolet and infrared light sources. |

HAZARD ASSESSMENT (cont'd)

| Hazard | Explanatory Notes | Methods of Test | Effects of Hazard | Examples |
|---|---|---|--|---|
| B. Safety Hazard | | | | |
| | 2. Ionizing radiation. Radioactive materials (uranium) Types: Alpha, Beta, Gamma | 2. Ionizing - Geiger counters, passive dosimeters | Ionizing - deep body burns, radiation sickness, sterility, death | 1. X-ray equipment 2. level or density gauges in manufacturing processes |
| 15. Hazardous Animals | Rats, pigeons, deer mice and other vermin and their by-products (excrement). | Visual | Respiratory disease, injury, ex: hantavirus, histoplasmosis | rats, pigeons, bats, deer mice |
| C. Type of Work to be Performed | | | | |
| | 1. The type of work undertaken can create additional hazards. Consider and plan for the hazards created by the work process. 2. Hot work, where the heat used or generated by the work process may cause an explosion. 3. Cold work, a situation where toxic substances or other hazards may exist. | Monitoring, visual, pre-job planning, work permit system. | Injury, disability, death | 1. welding (hot work) 2. sand blasting 3. bonding operations 4. grinding 5. using solvents 6. spray painting |
| D. Human Factors | | | | |
| 1. Phobias | Some workers are not suitable for work in confined spaces. As a result of these factors they can cause injuries to themselves or others. | Medical interview screening | Injury, disability, death | 1. claustrophobia 2. fear of heights |
| 2. Mental & Physical Condition | All workers must be mentally and physically capable of performing the work. | Visual, medical examination (pre-employment, annuals) | Injury, disability, death | 1. intoxication (alcohol, drug abuse) 2. impairment (prescription medication) |

SECTION D

SAFE WORK PRACTICES AND PROCEDURES

By developing and implementing safe work procedures, employers ensure that all workers involved in confined space entry work follow standardized methods, reducing the risk of injury or death. These procedures will include emergency response plans and rescue procedures to be followed in the event of an accident or other emergency in a confined space.

Training

Confined space work requires an effective training program that will provide awareness of safe work procedures. Base the training program on the specific hazards identified. Provide the training to all individuals who supervise workers, perform the work, or those assigned as standby or rescue persons.

- a) Trainers - It is essential that the training instructor have a thorough working knowledge of the following:
 - I. the confined space associated with the work activity
 - II. hazards involved
 - III. work practices and procedures
 - IV. atmospheric testing and monitoring requirements within the confined space
 - V. safety equipment, e.g. respirators; clothing, additional protection
 - VI. emergency response and rescue
 - VII. evaluation

- b) Workers - Training of workers entering and working in confined spaces is critical. To ensure worker safety, design the training program specifically for the type of confined space involved; the problems associated with normal entry and exit; and rescue procedures. Training should cover all types of confined spaces that may be encountered in the workplace or job description.

An effective training program will cover the following:

- Safe work practices and procedures for working in the confined space including:
 - I. personal protective and safety equipment
 - II. communication procedures – standby worker/worker/emergency
 - III. procedures for isolating, mechanical and electrical lock out, blanking, disconnecting pipes, lines and sources of energy
 - IV. emergency response and rescue procedures
- Recognizing the hazards associated with working in the confined space
- The content and control measures outlined in the required entry permit

Effective training can take place on the job, in classrooms and in simulated conditions. The employer must closely supervise on the job training until the worker has a complete understanding of potential hazards and has a complete understanding of confined space work practices.

The employer must evaluate worker competency to determine the need for re-training and upgrading. This should be done periodically, based upon employee evaluation and changes in the workplace.

Rescue

Always consider confined spaces to be immediately dangerous to life and health (IDLH), unless proven otherwise. Plan and prepare emergency response and rescue procedures for all confined space entry work. These procedures must be in place before any work commences. Take note that a very short period, approximately four minutes, without breathing can cause a worker to suffer permanent brain damage due to lack of oxygen.

For confined space entry, the employer must designate as a standby worker, one or more workers who are qualified in first aid level 1, 2, or 3 and trained in confined space work and emergency and rescue procedures. The designated standby worker must be present and remain at the entrance to the confined space at all times while a worker is in the confined space.

The employer must equip the standby worker and the worker in the confined space with suitable systems allowing them to communicate directly with each other and summon additional emergency assistance when necessary.

**WORKERS WHO ARE NOT TRAINED
IN PROPER RESCUE PROCEDURES
SHALL NOT UNDERTAKE OR BE
PERMITTED TO UNDERTAKE
RESCUE OPERATIONS.**

Worker to comply

An employer must ensure that a worker who is required or permitted to enter a confined space complies with the safe work practices and procedures respecting work in such a space.

Entry Permit System

The purpose of the entry permit system is to ensure proper identification of existing hazards in a confined space. It also ensures that necessary preventive and protective measures and procedures are in place to protect the health and safety of workers involved in confined space entry work.

The entry permit system, established by the employer, provides a checklist to verify that all hazards associated with work processes are taken into consideration.

The entry permit must be complete and signed by a competent person; and be readily available at the site of the confined space before a worker enters that confined space. It must contain the following information:

- a) Location of the confined space
- b) Names of each worker who will enter the confined space, the reason for their entry and the work that they will do
- c) Time during which the entry permit is valid. Entry permits will display the issue date and time of the permit and have an expiration time that will be valid for only one shift. Each shift shall have the permit updated.
- d) Safe work procedures for entering, being in, and leaving the confined space
- e) Complete isolation list
 - blanking and/or disconnecting
 - electrical lock-out
 - mechanical lock-out
 - any other applicable information
- f) Special clothing and equipment
 - personal protective equipment and clothing
 - full body harness, lifeline, and retrieval system
 - special tools for hazardous location work
- g) Atmospheric test readings
 - explosive levels and/or flammability levels
 - oxygen levels – deficiency or enrichment
 - toxic substances
 - others, as necessary
- h) Atmospheric monitoring, including type, while work is being performed
- i) Trained personnel, with a complete understanding of the hazard
- j) Standby workers must be named on the permit
- k) Signed authorization by the supervisor (competent person) for work to be done
- l) First aid provisions, emergency response and rescue procedures in place

Because of the diversity of work in confined spaces, it is not possible to have an entry permit that covers every situation. Assess each work situation and design a specific entry permit to cover it.

The employer must review and revise the confined space entry permit whenever the work activity changes or circumstances at the workplace change in a way that poses a risk to the safety and health of a worker. The employer must also inform workers, who may be affected by the change to an entry permit, of the change.

The employer or owner must take all practical and reasonable steps to prevent any person, other than a worker who is required or permitted to do so, from entering a confined space at the workplace.

Examples of the various types of work permits include:

- a) Hot work permit - where heat used or generated in work process is of sufficient intensity to cause an explosion or fire
- b) Cold work permit - where hazards from toxic gases. Fumes, dusts, mists, fogs, corrosive substances, biological agents exist or may exist
- c) Safety work permit – for work that involves steam, air, water, electricity
- d) Entry permit - for entering into confined spaces

See an example of an entry permit in Appendix B.

Lock out Provisions

Refer to Part 16 section 16.14 of Manitoba Regulation 217/2006 for full lock out requirements.

Lock out means the disconnection, blocking or bleeding of all sources of energy that may create a motion or action by any part of a machine and its auxiliary equipment.

Before a worker undertakes confined space entry work/activities, the employer or contractor shall ensure that all of the systems, that are part of the confined space, are disconnected from the power source at the disconnect box and that the controls are locked out, and remain locked out, to prevent accidental start-up. Systems include electrical, mechanical, steam, compressed (pneumatic) gas, hydraulic, gravity, wind, and radiation devices

An employer must develop and implement safe work procedures for the service, testing, repair and adjustment of a machine when

- the manufacturer's specifications require the machine to remain operative when it is serviced, tested, repaired or adjusted
- there are no manufacturer's specifications and it is not reasonably practicable to lock out the machinery when it is serviced, tested, repaired or adjusted

Blanking Off Procedures

The employer must ensure all lines and systems that may allow hazardous materials to enter a confined work space are blanked off. Material used in the construction of the blank must take the line pressure and corrosion properties into consideration.

Where it is impractical to employ blanks or blinds, as in welded piping systems, develop and implement safe work procedures that ensure equivalent protection for all workers exposed to the hazard.

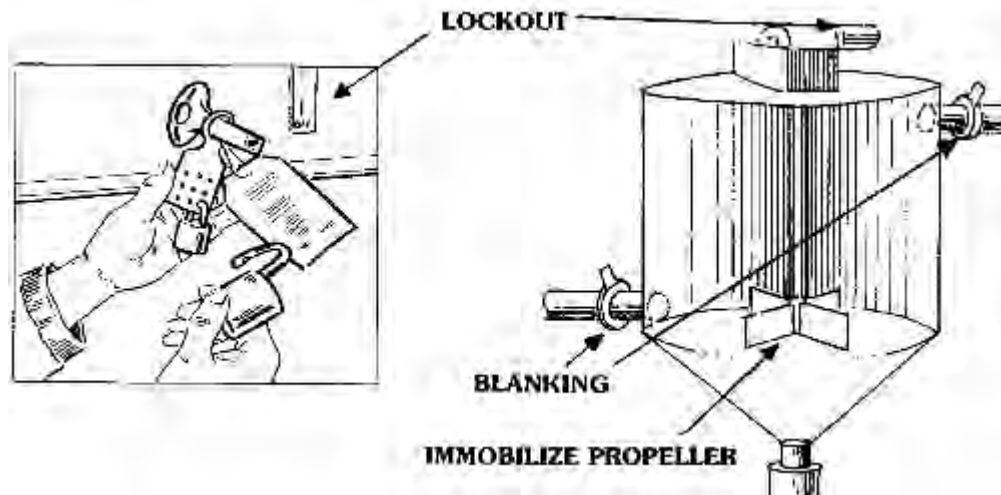

NOTE: ENSURE THAT YOU HAVE LOCKED OUT ALL ENERGY SOURCES THAT PRESENT A HAZARD TO A WORKER ENTERING, OCCUPYING, OR LEAVING THE CONFINED SPACE, AND PUT THOSE ENERGY SOURCES IN A ZERO ENERGY STATE.

Monitoring

Before entering any confined space, it is important to use appropriate monitoring equipment, determine the frequency of tests and inspections needed to protect workers from exposure to any identified hazard (e.g. atmosphere - explosive gases, oxygen levels, toxic gases) and ensure the tests and inspections are completed as appropriate.

MONITORING ACCURATELY IS EXTREMELY IMPORTANT - WORKERS LIVES DEPEND ON IT

Only workers who have received training and are considered qualified to use the monitoring equipment will carry out such monitoring. The training mentioned must include instrument calibration, equipment maintenance, and proper interpretation of instrument readings and warning signals.

All monitoring equipment must be serviced, maintained and calibrated to ensure it is working properly before each use. Maintain service logbooks for each piece of confined entry monitoring and testing equipment. An example is found in Appendix C.

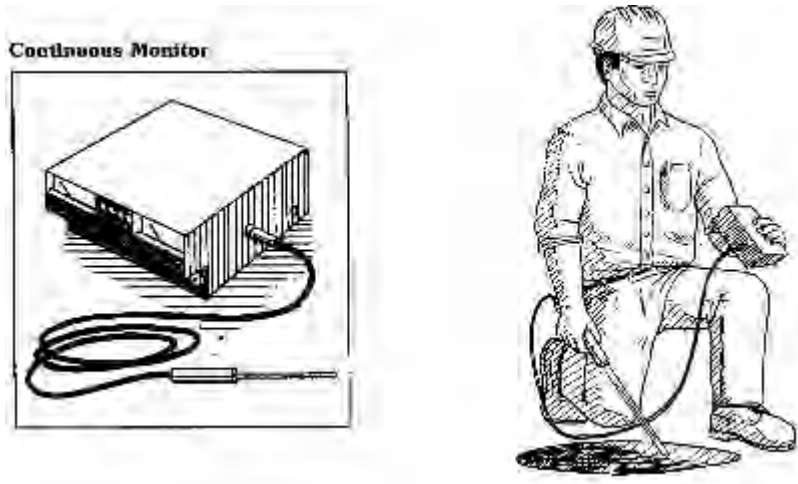

You will find a listing of allowable occupational exposure limits to various substances in a current edition of *Threshold Limit Values and Biological Indices*, a publication prepared by the American Conference of Governmental Industrial Hygienists.

If you do not know all airborne (breathing) hazards, then workers entering confined spaces must wear approved pressure-demand, supplied air breathing apparatus, and use continuous monitoring equipment for explosive atmospheres (Fig.13). The atmosphere should not be more than 10 per cent of the lower explosive limit. **Do not permit entry if concentrations of flammables or explosives cannot be reduced to less than 10 per cent of the lower explosive limit**

Ventilation and Purging/Inert

- a) **Ventilation** - a method of forcing air into a confined space near the bottom using a mechanical device. Do this if hazard/risk assessment and monitoring indicates the confined space has a hazardous atmosphere and there is a need for continuous ventilation to maintain a safe atmosphere. A competent person must continuously monitor the atmosphere and re-test after ventilating the space for an appropriate time and before any worker enters.
- b) **Purging** - a method of removing contaminants from a confined space by using liquids (water) or by non-flammable gases (carbon dioxide or nitrogen).
- c) **Inert** – refers to the process of introducing a substance, usually a gas, to make the contaminants non-reactive.

Specific Requirements before Entering a Confined Space:

- a) There must be safe ways in and out of all accessible parts of the confined space.
- b) The structural integrity of the confined space must be maintained when there are alterations to its physical characteristics to ensure safe entry and exit.
- c) A competent worker who is experienced and trained in all aspects of confined space entry work must be present to supervise workers who are in confined spaces and shall be responsible for all work and rescue procedures at all times.
- d) An appropriate number of standby workers trained in first aid (CPR) and rescue procedures must be in attendance and continuously monitor workers in the confined space. At all times, the standby worker must be prepared and be appropriately equipped to carry out a rescue. When entry to the space is from the top, at least two stand-by workers are recommended.
- e) The worksite must have a communication system capable of reaching an outside rescue agency. Make the outside rescue agency familiar with the workplace and working procedures.
- f) A communication system must be in place between the worker in the confined space and the standby worker. This may be visual, two-way radios or wired communications.
- g) Take measures to ensure workers will not be exposed to a risk of drowning or becoming trapped in any liquid or free flowing solid present in the confined space.
- h) Identify all energy sources that present a hazard to a worker entering, occupying, or leaving the confined space and put them into a zero energy state.
- i) Barricades and warning signs must be used to keep vehicles and pedestrian traffic away from an active confined work space.

- j) Fire Safety - where potential for fire and explosion exists, eliminate all ignition sources. Compressed gas cylinders shall not be taken into a confined space (this does not apply to breathing air cylinders). Welding and cutting hoses shall be brought in only for the immediate use and shall be removed immediately after use. Adequate fire fighting equipment shall be readily available. Use special non-sparking (non-ferrous) tools where necessary.

Electrical Safety

Lights and other electrical equipment must meet the requirements of *The Electricians Licence Act* and *The Manitoba Electrical Code*. Use ground fault interrupters (GFI) as additional protection for operators of electrical equipment, especially when water or other liquids are present.

Safety Provisions and Equipment for Confined Space Work

A worker entering a confined space shall be equipped with all safety apparatus, testing and monitoring equipment relative to the hazard/risk assessment for that confined space.

- a) Supplied air breathing apparatus - If hazard/risk assessment recognizes a need for breathing apparatus, (e.g. the concentration of an airborne substance meets or exceeds the occupational exposure limit), only two types may be used in confined spaces. Both are supplied-air pressure, demand type (refer to the most recent edition of *CSA standard Z94.4 – M*). Entry into confined spaces using breathing apparatus must also include continuous explosive atmospheric monitoring. Supplied breathing air must meet the purity requirements set out in the most recent edition of *CSA standard Z180.1 Compressed Breathing Air and Systems*.
- b) Self-contained breathing apparatus (SCBA) - Self-contained breathing apparatus provides complete respiratory protection in atmospheres containing toxic/harmful airborne substances where there is an oxygen deficiency. The wearer is independent of the surrounding atmosphere because the breathing system admits no contaminated air into the breathing zone of the wearer.

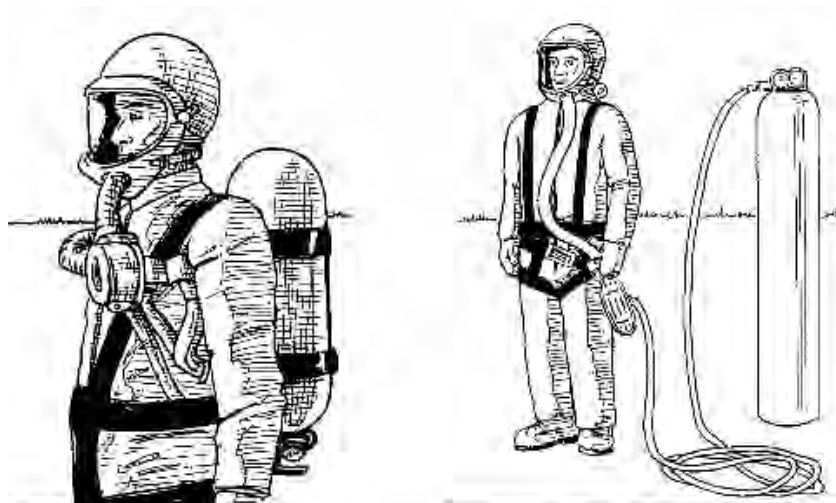

- i) Air line respirator - This is a variation of the self-contained breathing apparatus. The air line replaces the back-mounted tank and provides a source of breathing air. While this apparatus is lighter to wear, the length of the hose will limit the user's movements. You must use an escape bottle with this type of apparatus to provide an emergency supply of air. If a compressor is used, it must be an approved type.
- c) Full body harness with lifeline - The worker required to enter the confined space must wear an acceptable full body harness attached to a lifeline that is attached to a personal hoisting device that will facilitate rescue through a narrow opening. The lifeline cable must be a minimum of 3/16 - inch wire rope or other acceptable rigging, capable of a 10 to one safety factor. There may be a provision for alternate safe methods of access and egress where the use of a full body harness and lifeline would create an additional hazard or would not be reasonably practicable.



- d) Hoist/retrieval system - All hoisting components shall be capable of supporting a worker with a four-to-one safety factor. All hoists must be equipped with an adequate brake mechanism that allows for immediate fall arrest. The hoisting mechanism must be capable of immediate retrieval of the worker at all times. Any retrieval system must be capable of removing a worker within two and one-half minutes or less. An engineer must approve all shop-fabricated hoists.
- e) Personal protective equipment - Proper assessment of conditions and work process should identify additional personal protective equipment necessary for the task to be undertaken. The possibility of personal exposure to toxic substances and traumatic injury requires the consideration of full body protection.

- **If you can not fully assess the risks;**
- **If you can not monitor or test the atmosphere for harmful substances**
- **If you do not have continuous explosive gas monitors and breathing apparatus:**

DO NOT ENTER

Contact the Workplace Safety and Health Division for more information:

Winnipeg: 945-3446 (24 hour)
toll free: 1-800-282-8069
client services: 945-6848

Brandon: 726-6361

Thompson: 677-6821

Flin Flon: 687-1618



Appendix "B"

CONFINED SPACE ENTRY

SAMPLE PERMIT

Location of work: _____

Description of work (trades): _____

Employees assigned: _____

Entry date: _____ Entry time: _____

Outside contractors: _____

Isolation checklist:

- blanking and/or disconnecting
- electrical
- mechanical
- other

Hazardous work:

- burning
- welding
- brazing
- open flame
- other

Hazards expected:

- corrosive materials
- hot equipment
- flammable materials
- toxic materials
- drains open
- cleaning (e.g. chemical or water lance)
- spark producing operations
- spilled liquids
- pressure systems
- other

Vessel cleaned:

deposits _____
method _____
inspection _____
neutralized with _____

Fire safety precautions: _____

Personal safety:

- ventilation requirements
- respirators
- clothing
- head, hand, foot protection
- shields
- life lines and harnesses
- atmospheric gas tests
- communications
- employee qualified
- buddy system
- stand-by person
- emergency egress procedures
- training sign off (supervisor or qualified person) _____

| Test Performed: | Location: | Reading: |
|-----------------|-----------|----------|
| _____ | _____ | _____ |
| _____ | _____ | _____ |
| _____ | _____ | _____ |
| _____ | _____ | _____ |

Remarks: _____

Test performed by: _____
Signature

Time: _____

Authorizations:
Supervisor: _____
Production Supervisor: _____
Line Supervisor: _____
Safety Supervisor: _____
Other: _____

Entry and emergency procedures understood:

Stand-by worker: _____
Rescue: _____
Telephone: _____

Permit expires: _____

Classification: _____



**SAFE
WORK**

**S
A
F
E**
SPOT THE HAZARD
ASSESS THE RISK
FIND A SAFER WAY
EVERYDAY

**EVERYONE'S
RESPONSIBILITY**



Fall Protection Guideline

July 2008

Manitoba 

Fall Protection Guideline

Workplace Safety & Health Division
200 – 401 York Avenue
Winnipeg, Manitoba
R3C 0P8

July 2008



“The Province of Manitoba gratefully acknowledges WorkSafe BC, Province of Alberta, Alberta Construction Safety Association, Construction Safety Association of Ontario, and New Brunswick’s Workplace Health, Safety and Compensation Commission for permission to adopt content and illustrations from their publications related to fall protection.”

Fall Protection Guideline Table of Contents

| | |
|---|-----------|
| INTRODUCTION | 5 |
| Workplace Safety and Health Regulation Requirements | 5 |
| Reference Standards | 5 |
| RISK EVALUATION | 7 |
| SAFE WORK PROCEDURES | 7 |
| CONTROL MEASURES | 8 |
| Fall Protection Systems | 8 |
| SURFACE PROTECTION | 9 |
| Housekeeping | 9 |
| Slippery Work Surfaces | 9 |
| FIXED BARRIERS | 9 |
| Guardrails | 9 |
| Temporary Removal of Guardrails | 12 |
| Temporary Handrails | 13 |
| Surface Opening Protection | 13 |
| TRAVEL RESTRAINT SYSTEMS | 15 |
| FALL ARREST SYSTEMS | 17 |
| Swing Fall or Pendulum Effect..... | 23 |
| Bottoming Out..... | 24 |
| Clearance Distance..... | 25 |
| Permanent Anchorage System | 25 |
| Temporary Fixed Support System..... | 26 |
| Retractable Lifeline Fall Arrest System | 27 |
| Vertical Fall Arrest System | 28 |
| Horizontal Fall Arrest System..... | 30 |
| Inspection and Maintenance | 31 |
| Rescue After Fall..... | 32 |
| FIXED LADDERS | 34 |
| ANSI Standard A14.3 – Ladders – Fixed – Safety Requirements | 36 |
| AERIAL DEVICES AND SELF-ELEVATING WORK PLATFORMS | 38 |
| Standards regarding self-elevating work platforms and aerial devices..... | 39 |
| Guarding (Part 28, section 28.38 of M.R. 217/2006) | 41 |
| Fall Protection (Part 28, section 28.39 of M.R. 217/2006) | 41 |
| Maintenance, Records and Manuals (Part 28, section 28.40 of M.R. 217/2006) | 41 |
| Signs (Part 28, section 28.41 of M.R. 217/2006) | 42 |
| Climbing Prohibited (Part 28, section 28.42 of M.R. 217/2006) | 42 |
| Use of the self-elevating work platform or aerial device (Part 28, section 28.43 of M.R. 217/2006) | 42 |
| Inspection (Part 28, section 28.44 of M.R. s27/2006)..... | 42 |

| | |
|--|-----------|
| FALL CONTAINMENT SYSTEMS | 43 |
| Safety Nets | 43 |
| Inspection and Testing of Safety Nets..... | 43 |
| CRANE SUSPENDED WORK PLATFORMS | 44 |
| General restriction regarding use of cranes..... | 44 |
| Basket or cage requirements | 44 |
| Inspection and certification | 45 |
| Crane requirements and documentation..... | 45 |
| Operating requirements | 46 |
| STEEL ERECTION INDUSTRY | 47 |
| General Principles..... | 47 |
| Steel frame building requirements | 48 |
| Structural connection | 49 |
| Clipped end connection and staggered connection | 49 |
| Anchorage Points..... | 50 |
| Erection procedures..... | 51 |
| <i>Columns</i> | 51 |
| <i>Beams</i> | 52 |
| <i>Pre-Engineered Structures</i> | 52 |
| ROOF WORK | 53 |
| General Requirements..... | 53 |
| General Principles..... | 53 |
| Fall Protection Safe Work Procedures..... | 54 |
| Training | 54 |
| Worker To Comply..... | 54 |
| Determining The Fall Distance..... | 55 |
| Roof Openings | 56 |
| Work Near Roof Edge..... | 57 |
| <i>Guardrails</i> | 57 |
| <i>Warning Barriers / Control Zones</i> | 58 |
| Material Supply | 60 |
| <i>Roofing Hoists</i> | 60 |
| <i>Bitumen Pipe Discharge Area</i> | 61 |
| Ladders for Roof Work..... | 62 |
| <i>Safety Checklist</i> | 62 |
| RESIDENTIAL CONSTRUCTION..... | 63 |
| Safe Work Procedures & Training..... | 63 |
| General Principles..... | 63 |
| Fall Protection Safe Work Procedures | 64 |
| Changes to the Safe Work Procedures | 64 |
| Site Specific Safe Work Procedures Interpretation..... | 65 |
| Determining The Fall Distance..... | 65 |
| Procedure Based Fall Prevention Controls..... | 66 |
| Site Specific Fall Protection Requirements..... | 69 |
| <i>Working on top of foundation walls and formwork</i> | 69 |
| <i>Working atop unsheathed floor joists</i> | 70 |

| | |
|--|-----------|
| <i>Erecting Second Story Exterior Walls</i> | 72 |
| Installing Roof Sheathing | 77 |
| Sloped Roofs | 79 |
| Shingling – New Construction | 79 |
| Soffit, Fascia, Eaves Troughing and Siding Application | 80 |
| Working Alone in Residential Construction | 82 |
| Have a Plan in Case of an Emergency | 82 |
| Residential Roof Work on Existing Buildings | 83 |
| Roof Slope Requirements: Existing Structures Only | 83 |
| Requirements re: Slopes more than 6:12 – Existing Structures | 84 |
| DEFINITIONS | 86 |

INTRODUCTION

Falls account for a number of lost time injuries and fatalities at Manitoba workplaces.

Categories of Falls:

- Fall to work surface (ex. slips)
- Fall against / onto an object
- Fall from moving vehicle/equipment
- Fall from stairs, ramps and ladders
- Fall from one work level to the other
- Fall from edge of work level
- Fall into/through an opening

Workplace Safety and Health Regulation Requirements

The *Workplace Safety and Health Act* and Part 14 of the Manitoba Workplace Safety and Health Regulation (M.R. 217/2006) require specific actions to be taken to protect workers at risk of falling.

Note: additional requirements for residential construction can be found in Part 31 of M.R. 217/2006.

This guideline provides practical help in developing and maintaining safe systems of work, including safe work procedures, for workers working at elevated levels.

Reference Standards

- CAN/CSA Standard Z91– Health and Safety Code for Suspended Equipment Operation
- CAN/CSA Standard Z271 – Safety Code for Suspended Elevating Platforms
- CAN/CSA Standard Z259.1 - Body Belts and Saddles for Work Positioning and Travel restraint,
- CAN/CSA Standard Z259.2.1 - Fall Arrestors, Vertical Lifelines and Rails,
- CAN/CSA Standard Z259.2.2 - Self-Retracting Devices for Personal Fall Arrest Systems,
- CAN/CSA Standard Z259.2.3 - Descent Control Devices,
- CAN/CSA Standard Z259.10 - Full Body Harnesses,
- CAN/CSA Standard Z259.11 - Energy Absorbers and Lanyards
- CAN/CSA Standard Z59.12- Connecting Components for Personal Fall Arrest Systems,
- CAN/CSA Standard Z259.16- Design of Active Fall Protection System,
- CAN/CSA Standard Z259.13- Flexible Horizontal Lifeline System,

- ANSI 14.3 - Safety Requirements for Fixed Ladders American National Standard for Ladders – Fixed – Safety Requirement,
- ANSI Standard 10.11 - Safety Requirements for Personnel and Debris Nets
- American National Standard for Construction and Demolition Operations.
- CSA Standards regarding Ladders are listed under that specific section of this guideline.

Note:

The Workplace Safety and Health Division has prepared “STANDARDS Information Sheets” to summarize the general requirements of these noted Standards. Users are encouraged to obtain full copies of a referenced Standard.

Metric units of measurement in this guideline are provided according to the International System of Units.

If a value for measurement provided in this guideline is followed by an equivalent value in other units, the first value provided is to be considered as the requirement. The equivalent value (in parenthesis) may be approximate.

RISK EVALUATION

When assessing the workplace for fall hazards, it is important to conduct a complete risk evaluation. This evaluation can be done in the form of a job hazard analysis, where the work task is broken down into individual steps that are then analyzed to determine the hazards. Once the hazards have been identified, control measures and safe work procedures are developed and put in place to prevent falls at the workplace. (For more information on conducting job hazard analysis and developing safe work procedures please see the Workplace Safety and Health Division's SAFE Work Bulletins: 249(1), 249(2), and 249(3).

SAFE WORK PROCEDURES

Employers must develop and implement safe work procedures to protect workers from falls at the workplace before beginning work on a project.

(See the Division's SAFE Work Bulletin # 249 (3 of 3) for more information and a sample safe work procedure.)

Part 14 of Manitoba's Workplace Safety and Health Regulation (M.R. 217/2006) requires:

Safe work procedures:

14.1(1) This Part applies to every workplace where there is a risk of a worker falling

- (a) a vertical distance of 3m or more;
- (b) a vertical distance of less than 3m where there is an increased risk of injury due to the surface or item on which the worker might land;
- (c) into operating machinery or moving parts of the machinery;
- (d) into water or another liquid;
- (e) into or onto a hazardous substance or object;
- (f) through an opening on a work surface; or
- (g) a vertical distance of more than 1.2m from an area used as a path for a wheelbarrow or similar equipment.

14.2(1) An employer **must**

- (a) develop and implement safe work procedures to prevent falls at the workplace;
- (b) train workers in the safe work procedures; and
- (c) ensure that workers comply with the safe work procedures.

14.2(2) The safe work procedures must identify the fall hazards at the workplace and set out the measures that will be used to prevent falls at the workplace.

14.2(3) When this Part requires the use of a guardrail system or fall protection system at a workplace, the safe work procedures must address the following issues:

- (a) the location of each guardrail system or fall protection system to be used at the workplace;
- (b) the procedures used to assemble, maintain, inspect, use and disassemble a fall protection system;
- (c) where applicable, the rescue procedure to be used for rescuing a worker after a fall has been arrested.

The safe work procedures are to be documented and include:

- responsibilities of supervisors and workers on the project
- fall protection methods to be used
- personal protective equipment to be used

CONTROL MEASURES

Fall Protection Systems

The following systems provide effective fall protection for workers when properly designed, constructed and used:

- Surface protection (non-slip flooring)
- Fixed barriers (handrails, guardrails)
- Surface opening protection (removable covers, guardrails)
- Warning barriers/control zones (flat roofs / decks only)
- Travel restraint systems (lifeline and full body safety harness)
- Fall arrest systems (lifeline, shock absorber, and full body safety harness)
- Fall containment systems (safety nets)

When selecting a fall protection system, consider the circumstances and the job.

The ideal choice of fall protection for workers is one that removes the risk of falling entirely. For example, it is preferable to provide a fixed barrier to prevent a worker from access to an area that presents a risk of falling, than providing the worker with personal protective equipment (safety harness, shock absorbers, and lifeline) to protect them in the event of a fall.

SURFACE PROTECTION

Housekeeping

It is important to maintain good housekeeping practices at the workplace. This includes keeping the work area free of equipment and materials that are not required for the task at hand, and keeping the work surface free from trip or slip hazards.

Slippery Work Surfaces

If work surfaces become slippery because of work activities (ex. water, oil, grease) or environmental factors (ex. snow, ice), employers must ensure that workers are provided with a secure walking surface. Material spills must be cleaned up immediately, and in some cases, footwear with special soles may be required.

FIXED BARRIERS

A fixed barrier must be capable of stopping a worker from proceeding past the edge of a work level or into a floor opening. Barriers may be permanent or temporary, depending on the circumstances at the workplace. Fixed barrier types include: guardrails, handrails, ladder cages, fencing, and warning barriers.

Guardrails

A guardrail is a permanent or portable structural system intended to stop a worker from unintentionally stepping off a working level and falling to a level below.

Guardrailing consists of a top rail at a height of between 900mm and 1060mm (36 to 42 in) above the working surface, and a mid-rail at a height between 450mm and 530mm (18 to 22 in) above the working surface.

The guardrailing must be constructed and secured to resist a static load of 900 Newton's (200 lb force) applied in any direction at any point on the top rail and any intermediate rail.

If guardrailing is constructed of wood, it must be free from splinters and protruding nails and have a top and mid-rail of at least 38mm by 89mm (1 1/2 by 3 1/2 in) securely supported on posts no less than 38mm by 89 mm (1 1/2 by 3 1/2 in), and spaced no more that 2.4 m (8 ft) apart.

If there is a danger of materials or objects falling from the work surface to a working level below, a guardrail must have a toe board securely fastened to the posts, extending from the surface of the working area to a height of at least 125 mm (5 in).

Guardrail designs include:

- wood-slat,
- wire rope (with highly visible identifiers),
- steel frame,
- safety fencing,
- tube and clamp,
- perimeter netting and others.

Any of these is acceptable, as long as the system meets the basic design characteristics already mentioned. For example, where wire rope (cable) is used for a guardrail, it must be tensioned to provide the same strength protection as a wooden guardrail system with a top and intermediate (middle) rail.

Prior to and during the installation of a guardrail, it is essential that a full body safety harness and an independent lifeline, properly secured to an adequate fixed anchor, is used by every worker who may go near an open edge and be at risk of falling a distance of 3 m (10 ft) or more.

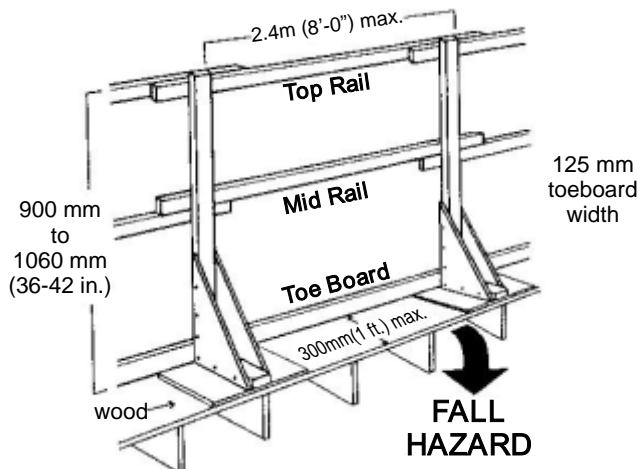

Note: If a guardrail system will be provided at a workplace, employers must ensure that the guardrail system will not exceed the loading conditions specified under the Manitoba Building Code for the surface that it is installed on.

Examples of Guardrails:

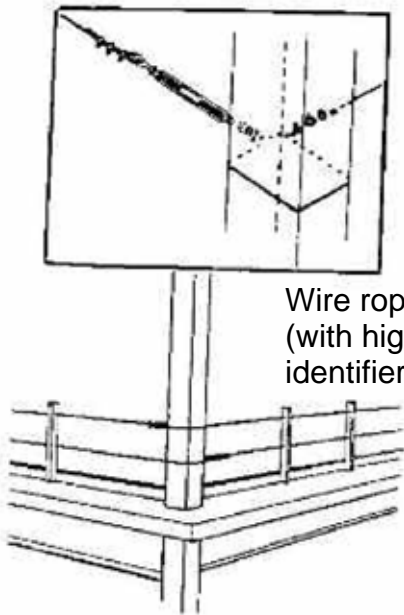

Wire rope guardrail
(with highly visible
identifier)

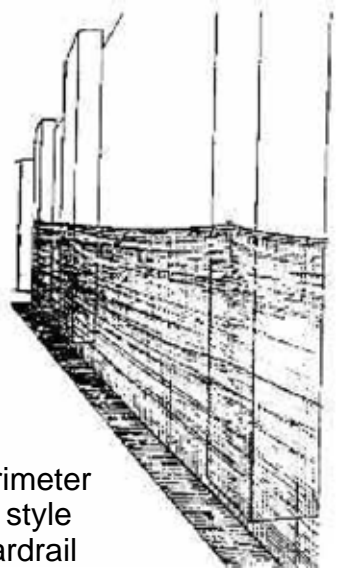

Perimeter
net style
guardrail

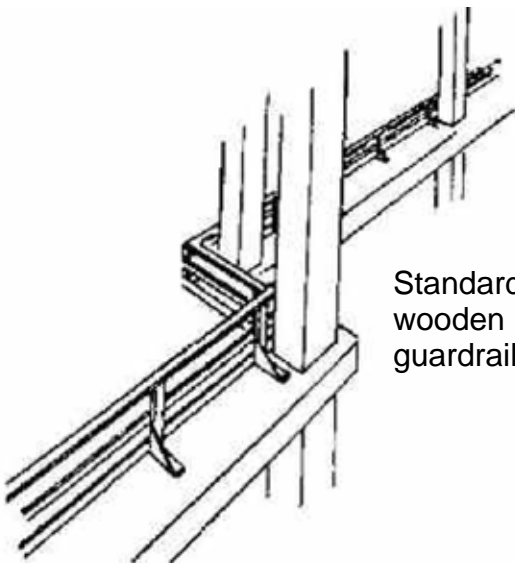

Standard
wooden
guardrail

Temporary Removal of Guardrails

Employers may temporarily remove a guardrail when it is necessary for work to be completed in the immediate area. Employers must ensure that workers in the area use a fall protection system while the guardrail is removed. If a guardrail is temporarily removed, warning signs or warning tape should be used to mark off the hazard area.

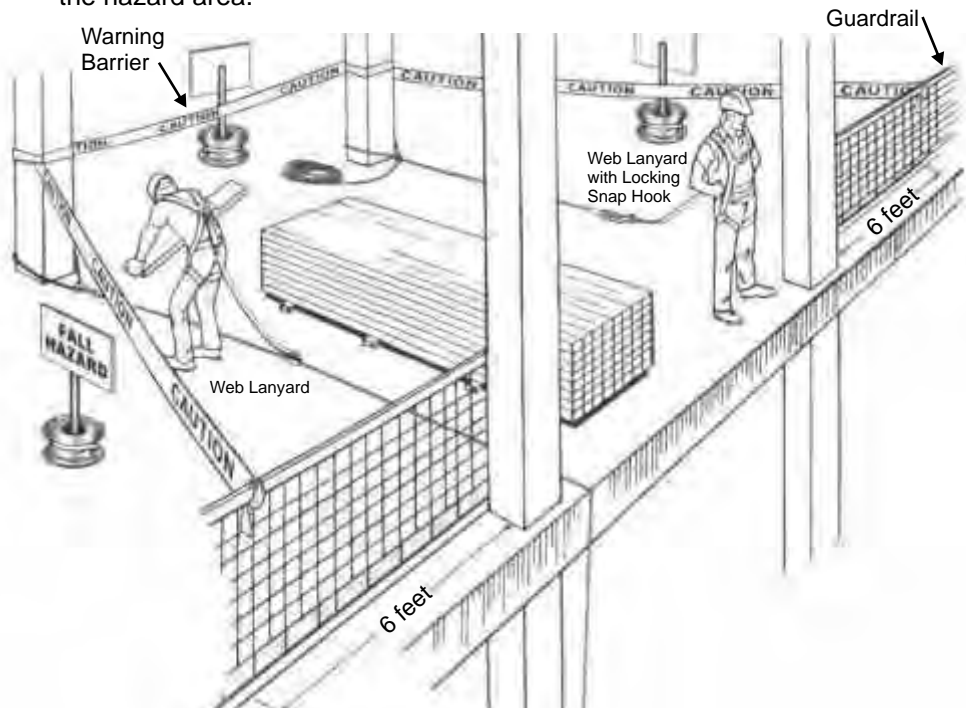

A warning barrier / control zone alerts workers that they are approaching a hazardous work area, where a potential fall hazard exists. The warning barrier / control zone is to be used when it is not practical to provide fixed barrier protection, or when a guardrail has been temporarily removed.

This warning system may consist of a cable, rope, or fencing system set up at least 1.8 m (6 ft) from the work surface opening or edge. A high visibility identifier should be used to mark the warning barrier.

A warning system / control zone is not a substitute for guardrailing as it offers no protection to the worker who must go near the edge of a work area. Workers who are required to go beyond the warning barrier must use a travel restraint or fall arrest system. Lifelines must not be tied to the warning system or barricade.

TEMPORARY HANDRAILS

Proper handrails must be provided on the open side of stairs, ramps and other similar means of access,. These serve as both a physical barrier and a means of support for workers moving up and down the access way. Handrails should be designed the same as guardrails, with a top rail, intermediate (middle) rail and a toe board, if workers are working below.

Note: If a permanent handrail system will be provided at a workplace, employers must ensure that the handrail system complies with the requirements specified under the Manitoba Building Code.

Examples of handrails

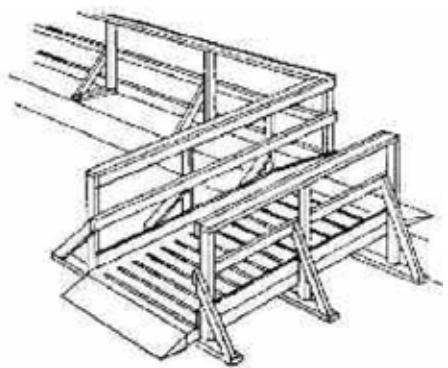

Surface Opening Protection

Guardrails/ floor coverings

Surface openings in floors and other walking surfaces accessible by workers must be protected by guardrailing, secured wood or metal covers. If wood or metal covers are used, they must be capable of supporting all loads that may be placed on them. The covering must also identify that there is an opening below (refer to Part 30 of the workplace safety and health regulation).

If plywood is used to cover openings, it must be a minimum thickness of 19mm (3/4 in) with proper support for the plywood.

If work must be done near unprotected openings that present a fall hazard of 3 m (10 ft) or more, access to this area must be restricted to workers wearing full body safety harnesses and lifelines secured to proper anchorage. Once the work is complete, the opening must be protected by guardrailing or adequate covering.

REMEMBER: If a fixed barrier or surface cover is removed for any reason, proper travel restraint or fall protection must be provided for any worker who must work near the unprotected opening.

Example of Surface Opening Protection:

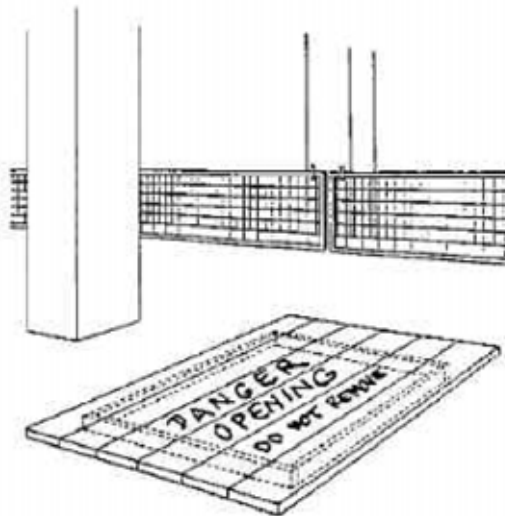
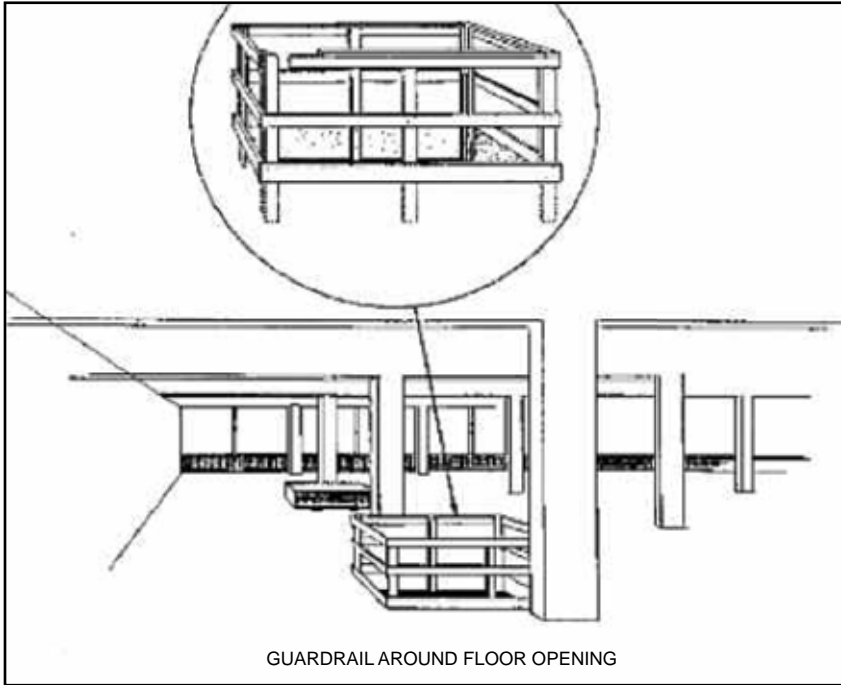

TRAVEL RESTRAINT SYSTEMS

Travel restraint systems prevent you from falling.

Examples include:

- Work-positioning systems, using full body harnesses, that attach you to an anchor and leave both your hands free to work, and
- Travel-restriction systems such as guardrails or personal fall protection equipment that prevent you from traveling to an edge from where you may fall.

When choosing a fall protection system, first consider installing guardrails or barriers. They provide a high degree of protection when installed properly. However, if it is not practical to install guardrails or barriers at a work site, personal fall protection equipment may be necessary.

Note: The regulation does not require the use of fall protection systems at fall heights less than 3m (10ft) unless there is an increased risk of worker injury due to the surface or item on which the worker might land, or there is a risk of a worker falling:

- into operating machinery or moving parts of the machinery;
- into water or another liquid;
- into or onto a hazardous substance or object;
- through an opening on a work surface; or
- a vertical distance of more than 1.2 m (4 ft) from an area used as a path for a wheelbarrow or similar equipment.

The Manitoba Workplace Safety and Health Regulation (M.R. 217/2006) states: “Despite the reference to safety (body) belts in CAN/CSA Standard Z259.1 Body Belts and Saddles for Work Positioning and Travel Restraint, an employer must ensure that a **safety (body) belt is not used** as part of a fall protection system at the workplace.”

Example of a travel restraint system

A travel restraint system is intended to limit a worker's movement so the worker is

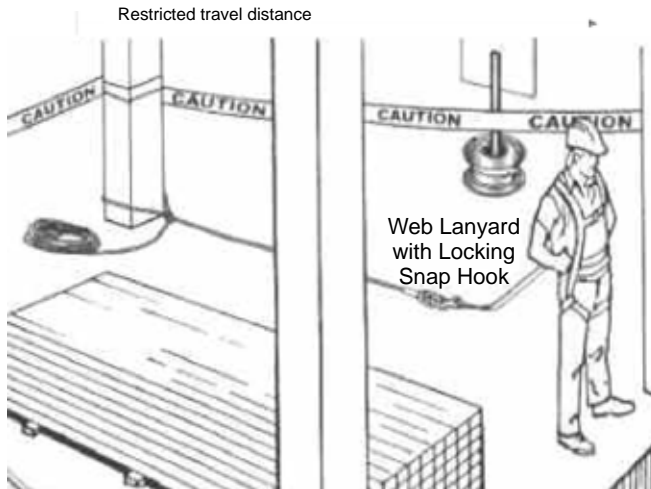

unable to reach a location where there is a risk of falling.

The restraint system consists of a full body safety harness, lifeline and/or lanyard and adequate attachment points.

The full body safety harness is attached to a lifeline, having a fixed length, which is attached to a fixed support meeting the requirements of section 14.14 of M.R. 217/2006.

The length of the lifeline or the lanyard is selected so that the worker can only proceed to within 1 metre (3 ft.) of an opening or edge.

Under no circumstances should a travel restraint system be rigged so that a worker is in a position to fall.

FALL ARREST SYSTEMS

Unlike a travel restraint system, a fall arrest system does not prevent a fall; it reduces the chance of injury when a fall takes place.

A complete fall arrest system consists of adequate attachments points, lifeline, fall arrestor, lanyard, shock absorber, and full body safety harness.

A 100 kg (220 lbs) worker free falling 1m (3 ft) generates an impact force of approximately 12 kN (2,700 lbs).

See Specifications for Fall Arrest Systems in the next section.

Pre-engineered (pre-manufactured) fall protection systems that suppliers may provide as kits, have to be installed, used and maintained according to manufacturer specifications. These temporary fall protection systems can be installed in different locations.

Permanent, site specific fall protection systems designed by a professional engineer, are specific to a certain location.

Both systems include the following components:

1. **Full body safety harness** - a device consisting of connected straps, designed to contain the torso and pelvic area of a worker, with an area to attach a lanyard, lifeline or other component, used to support the worker during and after a fall. A Grade 'A' full-body safety harness conforming to Canadian Standards Association CSA-Z259.10 "Full Body Harnesses" must be used for a fall arrest system.

Full body harnesses have four main functions:

- (1) to securely hold the worker's body during free fall, deceleration and final arrest;
- (2) to distribute arrest forces to those parts of the body able to absorb the forces without significant injury. Full body harnesses with straps that pass across the buttocks are particularly good at doing this;
- (3) to keep the body in an upright or near upright position after the fall and until the worker is rescued; and

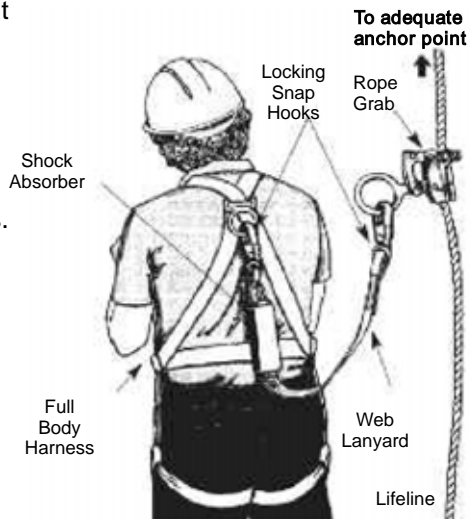

(4) to allow workers to do their work without restricting their movement.

CSA Standard Z259.10 lists five classes of full body harness according to their intended use:

- Class A harnesses shall have one D-ring for fall arrest attachment affixed to both shoulder straps at the back. Note: It is recommended that Group A harnesses be provided with a sub-pelvic strap and a sliding D-ring for fall arrest attachment.
- Class D harnesses shall have front or side-mounted D-rings, but they shall not be mounted at waist level.
- Class E harnesses shall have a sliding D-ring on each shoulder strap.
- Class L harnesses shall have one (1) or two (2) D-rings attached to the front of the harness.
- Class P harnesses shall have D-rings mounted at waist level.

Regardless of which group the harness belongs to, every harness must be able to arrest a fall and therefore meet the requirements of Group A harnesses. A full body harness designed to arrest falls has:

- (a) a back mounted D-ring located between the shoulder blades;
- (b) the letter “A” stenciled on each shoulder strap below the D-ring; and
- (c) an arrow stenciled above each letter “A” pointing up at the D-ring. The arrows on the shoulder straps point to the only D-ring on the harness designed to safely arrest a fall.

Example of a Full Body Harness:

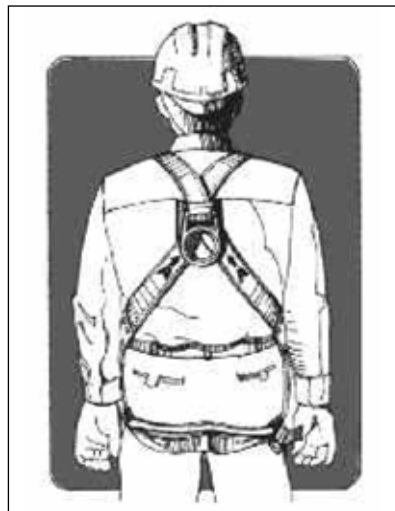

- 2. Carabiners, D-rings, O-rings, Self-locking Connectors and Snap hooks –** Carabiners, D-rings, O-rings, oval rings, self-locking connectors and snap hooks that are used to connect the components of a personal fall arrest system are subjected to the full maximum arresting force developed during a fall. The failure of any portion of this connecting hardware can lead to the failure of the entire fall arrest system.

For compliance purposes, D-rings, O-rings, oval rings, self-locking connectors and self-locking snap hooks must meet the requirements of CSA Standard Z259.12, *Connecting Components for Personal Fall Arrest Systems (PFAS)*.

Snap hooks are a Class I connecting component that consists of a hooked-shape body having a self-locking and self-closing feature that may be opened to permit the body to receive an object and that, when released, automatically closes and locks to prevent inadvertent opening. Snap hook connectors also have an integral closed eye, either fixed or swiveling, to be permanently fastened to a subsystem.

Snap Hook



Carabiner



To comply with the CSA Standard, only snap hooks and carabiners that are self-closing and self-locking can be used as interconnecting hardware in fall arrest systems. For these connecting components to be acceptable for use, their gates require at least two consecutive, deliberate actions to open.

Snap hooks and carabiners that are **not self-closing or self-locking** cannot be used as connecting hardware in personal fall protection systems and must be removed from use and storage.

The introduction of this self-closing, self-locking requirement is intended to prevent “roll-out”. When a force is applied on the top of a non-locking gate, the gate opens, releasing the mating hardware. The most typical roll-outs have been known to occur between snap hooks and D-rings.

- 3. Shock absorber** - This is a device that limits the force applied to the user when a fall occurs. It is designed to absorb the kinetic energy of the fall as the worker is stopped.

Shock absorbers serve three main functions:

- (1) to reduce the maximum arresting force on the worker's body during arrest of the fall. A worker's fall distance is not what injures or kills the worker — the critical factor is the quantity of energy the worker's body must absorb. Since the quantity of energy the human body can safely absorb during fall arrest is limited, the fall arrest system must absorb as much of the fall energy as possible;
- (2) to lessen or prevent damage to other components of the fall arrest system; and
- (3) to lower the force acting on the fall arrest system anchor.

A shock absorber may be a separate device or built into the lanyard design. Lanyards should conform to the latest edition of CSA Z259.11 "Energy Absorbers and Lanyards ". A shock absorber approved to the CSA standard is permitted to permanently extend up to 1.2 metres (4 feet) when arresting a 100 kilogram (220 pound) mass falling freely 1.8 metres (6 feet). The maximum arresting force is limited primarily through elongation of the shock absorber. The user or designer of a fall arrest system incorporating a shock absorber must, therefore, consider the increase in the total fall distance due to extension of the shock absorber.

Employers must ensure that the fall arrest system does not include a shock absorber if wearing or using one could cause a worker to hit the ground or an object or level below the work.

- 4. Lanyard** - means an approved device consisting of either a flexible line of webbing, synthetic fibre or wire rope that is used to secure a full body harness to a lifeline or anchor. A lanyard is always positioned between the anchor point and the worker's safety harness. Lanyards should conform to CSA Standard Z 259.1- Body Belts and Saddles for Work Positioning and Travel Restraint.

Examples of lanyards:

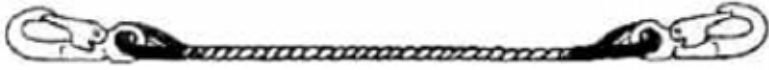

Nylon rope lanyard

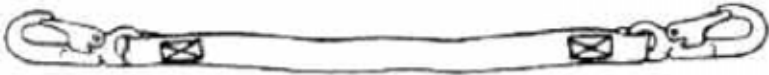

Synthetic web lanyard



Wire rope lanyard



Adjustable length web lanyard with shock absorber



Fixed length web lanyard with shock absorber

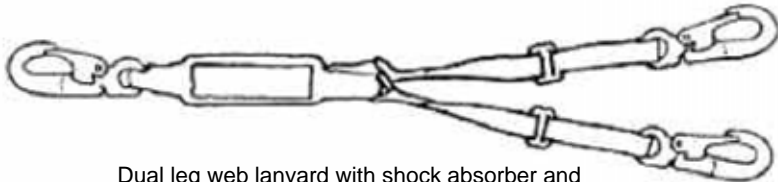

Dual leg web lanyard with shock absorber and adjustable legs



Web lanyard with shock absorber



Shock absorber lanyard

5. Fall arrestor (rope grab) – commonly referred to as a rope grab or cable grab, is used when workers need to move vertically, normally over substantial distances. A fall arrestor is fitted between the lifeline and lanyard and normally slides freely on a vertical rope or rail (lifeline), following the worker's movements until there is a sudden downward motion. When this sudden motion occurs, the fall arrestor "grabs" the lifeline and holds firmly. Fall arresting mechanisms are also built into retractable lifeline devices that play out and retract as necessary, but hold fast in the event of a fall. (Similar to a seat belt in an automobile). There are four classes of fall arrestors. Refer to the latest edition of CSA Z259.2.1 "Fall Arrestors, Vertical Lifelines and Rails" and CSA Standard Z 259.2.3 – "Descent Control Devices".

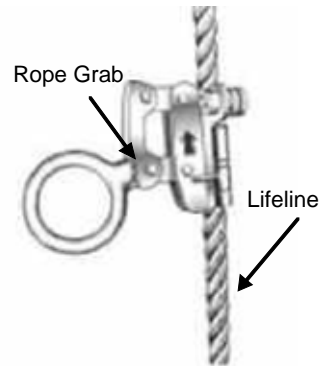

6. Body-holding device – a device intended to support the weight of an individual in the event of a fall. It is also designed to prevent or minimize injury to the individual resulting from the forces placed on the body during arrest of the fall and subsequent suspension. Body-holding devices may also be designed to support an individual's body weight during the use of a descent control or work-positioning device, or to function as part of a work restraint system. This will not replace the use of the full body harness in a fall arrest system, it will ease holding the person after the fall has been arrested.

Lifeline – defined as a flexible synthetic line or rope made of fibre, wire or webbing, rigged from one or more anchors to which a worker's lanyard or other part of a personal fall protection system is attached. This part of the system is attached to the anchor point and the user of the system. Lifelines must have a minimum strength equivalent to 60mm (5/8 in) diameter polypropylene fibre rope. Lifelines must be properly secured to the anchorage point and be protected from abrasion or damage along their full length. Lifelines may run vertically or horizontally (installed between two or more anchors), depending on the application. Horizontal systems must be engineered, due to the loading applied to the anchors. Standards providing detail on the design requirements of vertical and horizontal lifelines include: *CSA Z259.2.1 "Fall Arrestors, Vertical Lifelines and Rails"*, *CSA Z259.16 "Design of Active Fall –Protection Systems"* and *CSA Z259.13 Flexible Horizontal Lifeline Systems*". For a summary of these standards, refer to the Workplace Safety and Health Division's Standards Information sheets; for complete details, refer to the standards themselves.

Temporary lifelines are made of wire or synthetic rope. Permanent systems may be made of rigid steel or aluminum rails, wire ropes, or similar materials.

7. Anchorage point – (anchor) a secure point of attachment for a lifeline or lanyard. Parts of structures that happen to be located in the vicinity of where a worker is working are often used as anchors for travel restraint and fall arrest systems. Although their number is increasing, relatively few of these anchor points are manufactured to any technical standard. Employers must ensure that workers required to use fall protection equipment are capable of assessing an anchor's strength, stability and location.

Swing fall hazards must be considered when selecting an anchor point. Ideally, work should be performed directly below the anchor point. The further a worker is away from this ideal position, the greater the potential for the worker to swing like a pendulum into objects if the worker falls. In situations where swinging cannot be avoided, but where several equally good anchor points are available, the anchor point selected should direct the swing fall away from objects rather than into them. Where there is a choice among anchor points, the one offering the least amount of swing should be selected. See the figure below:

Swing fall or pendulum effect:

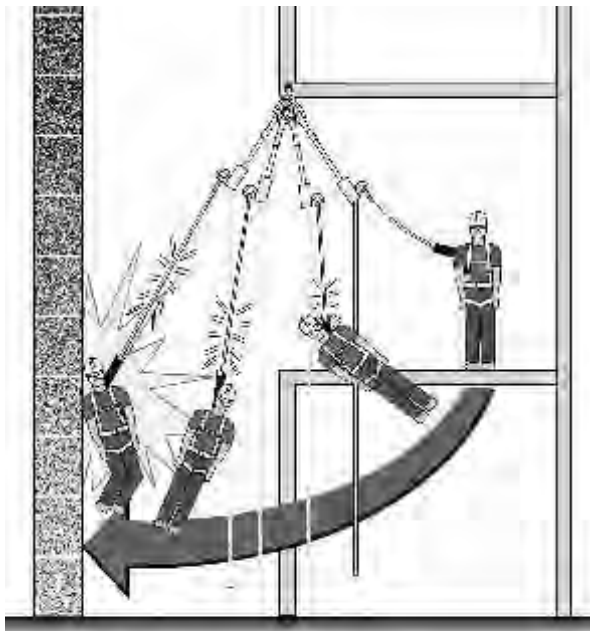

Bottoming Out:

Bottoming out occurs when a falling worker hits a lower level, the ground, or other hazard before the fall is fully arrested. This occurs when the total fall distance is greater than the distance from the work surface to the next level, the ground, or some other hazard below.

A personal fall arrest system must be planned, designed, and installed to provide sufficient clearance distance so that a worker cannot hit the ground or an object or level below the work area. Various factors must be accounted for in typical clearance calculations, including: the sag of the lifeline (if a horizontal life line is used), the length of the lanyard, shock absorber (deceleration distance), harness stretch, height of the worker, and a safety factor providing clear space between the worker and the lower surface or object.

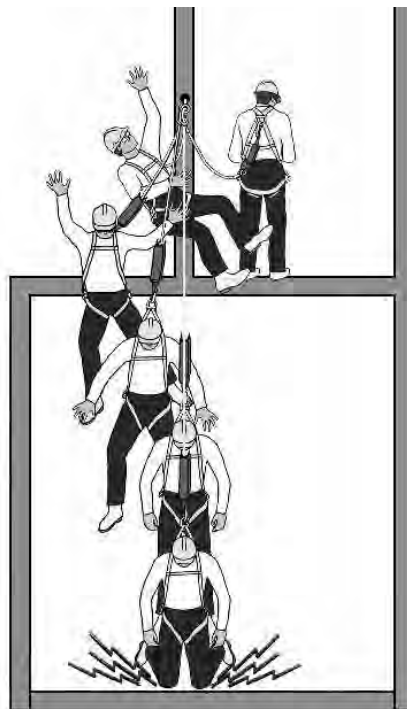

Clearance Distance:

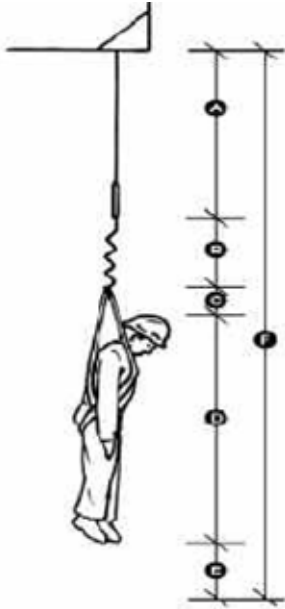

Example:

A worker is 1.8m (6ft) tall using a 1.8m(6ft) long lanyard. The combined weight of the worker, clothing and tool belt is at least 100kg(200 lbs).

- A Length of lanyard – 1.8 m (6ft)
- B 1.1m (3.5 ft) deceleration (shock absorber pulling apart)
- C Harness stretch plus D-ring sliding – 0.45m (1.5 ft)
- D Height of worker – 1.8m (6ft)
- E Safety factor – clearance below feet of ~ 2-3 feet)
- F $A+B+C+D+E$
Overall minimum clearance is 6.0m (20ft)

A worker's lanyard should be attached to an anchor no lower than the worker's shoulder height. If an anchor at shoulder height is not available, the lanyard should be secured to an anchor point as high as reasonably practical. Tying to an anchor at foot level is dangerous. The problem of securing a lanyard to an anchor at an appropriate height may be solved by employing one of the following anchor systems:

Permanent anchorage system:

Employers must ensure that a permanent anchorage system used as the fixed support in a travel restraint system or fall arrest system meets the following requirements:

- (a) the anchor has an ultimate capacity of at least 22.2 kN (5000 lbs) in any direction in which the load may be applied for each worker attached;
- (b) the anchorage system is certified by a professional engineer as having the required load capacity;
- (c) where the anchorage system is used in conjunction with a suspended work platform, the system is designed, constructed and used in accordance with CSA Z-91 Health and Safety Code for Suspended Equipment Operation and CSA Standard Z-271 Safety Code for Suspended Elevating Platforms.

Temporary fixed support system:

If a permanent anchorage system cannot be used at a workplace, employers must ensure that the temporary fixed support in a travel restraint system or fall arrest system meets the following requirements:

- (a) if a fall arrest system without a shock absorber is used, a support used in a fall arrest system must be capable of supporting a static force of at least 8 kN (1800 lbs) without exceeding the allowable unit stress for each material used in the fabrication of the anchor point;
- (b) if a shock absorber is used in a fall arrest system, the support must be capable of supporting a static force of at least 6 kN (1350 lbs) without exceeding the allowable unit stress for each material used in the fabrication of the anchor point;
- (c) a support used in a travel restraint system must be capable of supporting a static force of at least 2 kN (450 lbs) without exceeding the allowable unit stress for each material used in the fabrication of the anchor point.

If the anchor is exposed to environmental elements that might affect its performance, it must be corrosion resistant. (The minimum thickness of an eyebolt type anchor is 19mm ($\frac{3}{4}$ in) with a 38mm ($1\frac{1}{2}$ in) opening diameter.)

Note: a fall arrest system must be rigged to limit the fall of a worker to a maximum of 1.2 m (4 ft).

Lifelines may be of the fixed length type, adjustable with rope grab or self adjusting (retractable) type. Shock absorbing mechanisms are available either incorporated into the lanyard, or as an add-on.

Limit to peak dynamic arrest force: The fall arrest system must be designed not to subject a worker who falls to a peak dynamic fall arrest force greater than 8 kN (1800 lbs).

Retractable Lifeline Fall Arrest System

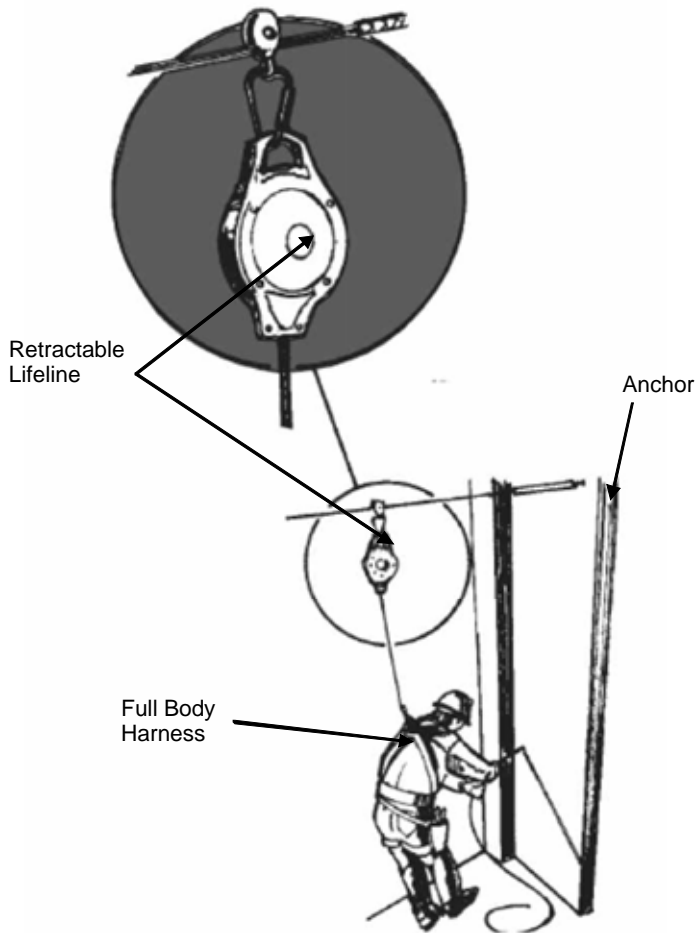

Vertical Fall Arrest System

A Vertical Fall Arrest System is a pre-engineered vertical system that arrests the fall of a worker when it occurs. The system consists of: anchor points, vertical lifeline, lanyard, shock absorber, full body safety harness and connecting components. All of these components must be chosen to provide the appropriate level of protection, limit the fall distance to 1.2m (4 ft.) and the peak acceleration force exerted to a person's body to 8 kN (1800 lbs). As a result, the person using the system will not experience bodily harm in case of a fall.

The anchor point for a fall protection system must be installed to provide the required strength for the system. Permanent installations have to have 22.2 kN (5000 lbs.) for every person rigged to the system and have to be installed, maintained and inspected according to professional engineer requirements. A Pull test or Strength test must be conducted to ensure that strength of the anchor is achieved. Inspection protocols shall be developed in order to ensure that the strength of the anchor is maintained (ex. an outdoor permanent anchor must be inspected at least once a year in order to ensure its capacity).

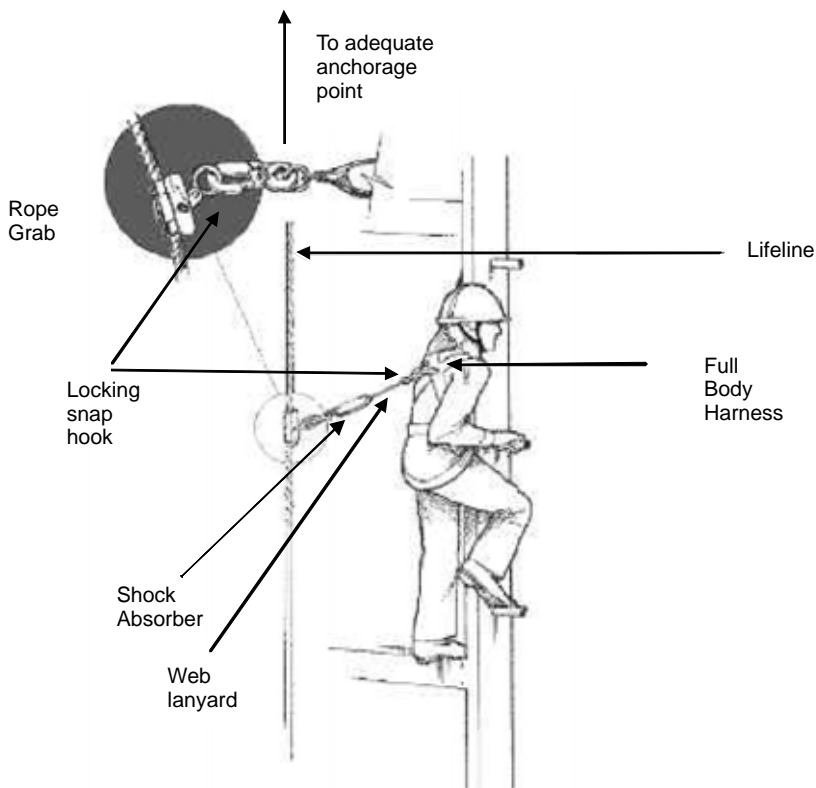

A vertical lifeline must be positively secured to an appropriate anchoring point as described previously. It may consist of a single line secured to a column or overhead beam to which the worker attaches a fall arrestor, or a retractable block device with a lifeline that automatically reels in and out, but engages when a slip or fall occurs. Lifelines must be protected from abrasion or chafing and from sharp corners which can break the lines under heavy shock loads.

Only one worker may be connected to each independent vertical lifeline. If multiple vertical lifelines are used at the same time, each lifeline must be secured to its own, independent anchor point. This limits the loading to which an anchor point is subjected and in the event of anchor failure, restricts the number of lifelines and workers potentially affected by the failure. If a vertical life line is being used at the same time that a worker is using a suspended work platform, the vertical lifeline must be secured to an anchor point that is independent of those supporting the suspended work platform. Suspended work platforms have to be installed and used according to CAN/CSA Z271 Safety Code for Suspended Elevating Platforms and CAN/CSA Z91 Health and Safety Code for Suspended Equipment Operation.

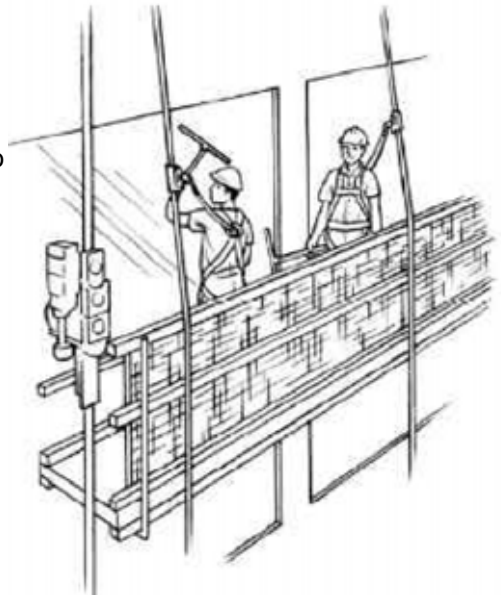

A fall arrest system is also essential with a boatswain chair. The system must be used at all times when a person is getting on, working from, or getting off the chair. A boatswain chair is commonly used in the window cleaning trade. It is very useful in situations where workers must progressively descend from one level to another. It cannot be used to climb. It is standard practice for boatswain chairs to be reeved with two suspension lines. This is because the ropes are easily damaged and the second suspension line provides added safety. A worker using a boatswain chair must have a separate lifeline with a separate anchor attachment.

Boatswain chair with descent control device



Boatswain chair with powered climber



Horizontal Fall Arrest System

A Horizontal Fall Arrest System is an engineered horizontal system that arrests the fall of a worker when it occurs. **The system must be designed by a professional engineer, inspected after installation, and maintained according to specifications.**

Two CSA standards provide detail on the design, testing, installation, manufacturing, labeling and maintenance requirements of these systems: CSA Z259.16 Design of Active Fall Protection Systems and CSA Z 259.13 Flexible Horizontal Lifeline Systems. Refer to the standards for full details or the Workplace Safety and Health Division's Standards Information sheets for summaries of the requirements.

The system consists of: a minimum of two anchor points; horizontal lifeline; lanyard; shock absorber; full body safety harness and connecting components. It can be designed to accommodate multiple workers. The free fall distance must be limited to 1.2 m. (4ft.) and the peak acceleration force exerted to the person falling is 8 kN (1800 lbs), in order to prevent bodily harm.

A horizontal lifeline extends (horizontally) between a minimum of two anchors and consists of a flexible line made of wire, fiber rope, wire rope, or rod, complete with end terminations, and it may have intermediate anchorages to reduce sags.

The lifeline must be designed by a professional engineer and prototype tested to ensure that it is capable of supporting the same impact load as a fixed anchor. A standardized horizontal fall arrest system may be used at different project sites, subject to the design criteria of the professional engineer.

The design engineer must approve the number of workers that may be secured to the same static horizontal line.

All other components of these two systems shall meet the requirements outlined in the standards noted.

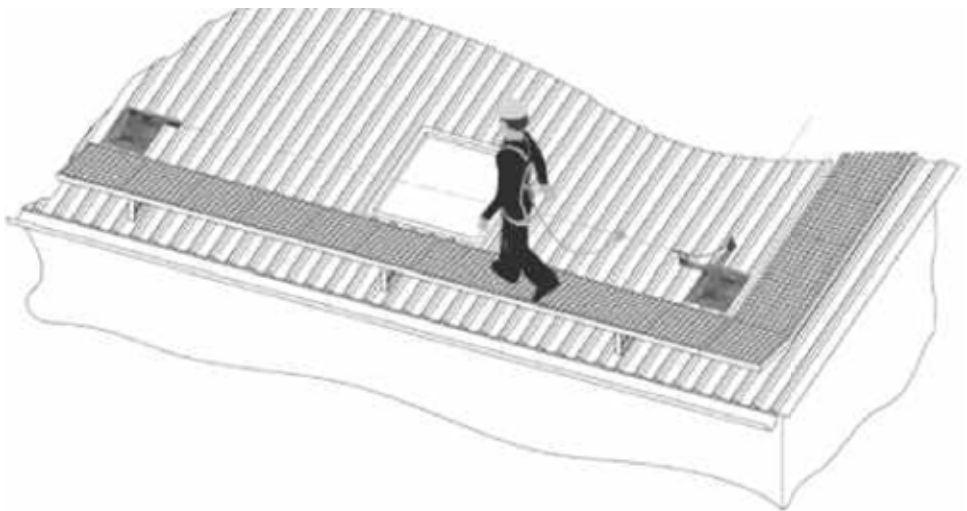

Inspection and Maintenance

Fall protection equipment must work properly when it is needed. According to the manufacturer's specifications and section 14.8(1) of M.R. 217/2006, the equipment must be inspected by the worker, or competent person other than the worker using the system, before use on each work shift. The equipment must also be protected from exposure to harsh conditions; kept free from any substance or condition that could deteriorate the equipment; be maintained in good working order according to the manufacturer's specifications; and be re-certified as required by the manufacturer.

Each component comes with instructions for maintenance and inspections. Workers must be trained in the proper maintenance and use of all components.

Before using fall-arrest equipment, check components carefully:

- **Harness** - make sure that straps, buckles, and other hardware are intact and undamaged. Look for frayed, cut, cracked, burned or damaged webbing, and loose or broken stitching. D-ring: look for bent cracked, nicked or gouged rings.
- **Lanyard** - Inspect along the length of the lanyard and eye splices. For a three-strand rope lanyard, carefully twist the rope open to look for worn, broken or cut fibres. Do not overtwist, or the rope could become deformed. Check web lanyards for cuts or holes; for worn or frayed parts, or for damage on load-bearing stitches. Discard the lanyard if any of the above defects are found.
- Inspect **shock-absorbing lanyards** regularly. Look for torn stitching on tear-away types. Check for other types of damage such as cracks and loose parts.
- **Lifelines** - Inspect fibre rope lifelines for fraying, burns, kinking, cuts and signs of wear and tear. Exposure to sunlight causes most synthetic fibre ropes to deteriorate over time. Look for signs of chafing or abrasion; cuts in the yarns or strands; or any visible deformities that would weaken the rope or interfere with the free movement of rope grabs, etc.
- Check **retractable block lifelines** for smooth operation. Pull out the line and jerk it quickly. Braking action should be immediate and maintained (good and tight).
- **Never use lanyards as tow ropes; to lift objects; or for other purposes than for what they are intended.**

REMOVAL FROM SERVICE

A fall arrest system that has arrested a fall must be removed from further service until all components are inspected and re-certified as safe for use by the manufacturer or a professional engineer (M.R. 217/2006, section 14.9). Shock absorbers for example, may have partially or completely deployed and self-retracting lifelines may require adjustment, repair or replacement.

Rescue After Fall

Manitoba Regulation 217/2006, section 14.2 (3)(c) requires written (fall rescue) safe work procedures to be in place in the event a rescue is required to retrieve a worker after a fall has been arrested. After an arrested fall, the fallen worker remains suspended in mid-air from his or her full body harness, awaiting rescue. In most cases, the worker is not injured and can alter body position within the harness to be more comfortable.

Unfortunately, a worker suspended in an upright position with the legs dangling in a harness of any type may experience “suspension trauma.”

While suspended in a harness, the worker cannot fall into a horizontal position. Fall victims can slow the onset of suspension trauma by pushing down forcefully with the legs; positioning their body in a horizontal or slightly leg-high position; by standing up, or using a body holding device. However, the design of the harness, the attachment points used, or the presence of fall injuries may prevent these actions.

The suspended worker may face several issues:

- (1) the worker is suspended in an upright posture with legs dangling;
- (2) the safety harness straps exert pressure on leg veins, compressing them and reducing blood flow back to the heart; and
- (3) the harness keeps the worker in an upright position, regardless of consciousness.

Rescue must happen quickly because the suspended worker may lose consciousness in as few as five minutes.

There are two ways in which a worker may be rescued:

Simple Rescue Plan – Used if a worker has fallen and is hanging from a fall protection system, but has not suffered an injury. Equipment that may be used to reach a suspended worker and get them down quickly, include: nylon or rope rescue ladders, extension ladders, manlifts, elevating work platforms, etc.

Injured Worker Rescue Plan – Used if a worker has fallen; is hanging from a fall protection system, and has suffered an injury that makes a self-rescue impossible. This type of rescue is much more difficult and complex to perform. Specially trained and equipped personnel may be needed. In extreme cases, the local emergency services department may use high-reach equipment or rappelling techniques to reach trapped workers and lift or lower them to a safe level.

Rescue plans should cover the on-site equipment, personnel, and procedures for different types of rescue. *Any off-site rescue services that might be required should be contacted and arranged in advance to familiarize them with the project.* Site management must ensure that:

- Everyone on site is aware of the rescue plan,
- Equipment and other resources are available, and
- Designated personnel are properly trained.

FIXED LADDERS

Vertical fixed ladders extending more than 5 m (16 ft) must be equipped to protect a worker from falling. Ladder cages and rest platforms must be provided every 5 m (16 ft), or a fall protection system that meets regulatory requirements.

A ladder cage is a permanent structure attached to a ladder that provides a barrier between the worker and the surrounding space. It serves only as a support to a worker if the worker needs to rest against the barrier. It does not provide fall protection on its own.

A more effective approach is to provide a complete fall arrest system as part of the ladder design. This could be a permanently installed metal rail or wire rope anchoring system with an automatic fall arresting device. The automatic fall arresting device would travel freely on the rail or cable, allowing the worker to use both hands while climbing up or down.

Should the worker slip or fall, the device would lock instantly and limit the worker's fall to a matter of inches.

Another method is to mount a retractable fall arresting device to a fixed anchor at the top of the ladder. The worker would then be equipped with a full body safety harness secured to the end of the retractable lifeline, and be in a position to move safely up and down the ladder.

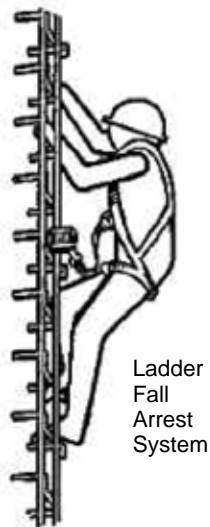
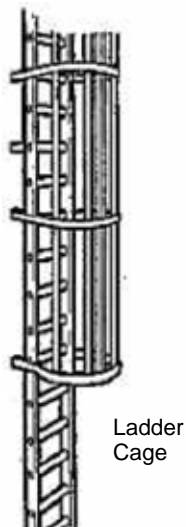

Fixed ladders – The following requirements are listed under Part 13 of MR 217/2006:

13.20(1) An employer and an owner must ensure that a ladder that is permanently fixed to a supporting building or structure

- (a) is designed by a professional engineer, as is its permanent attachment system to the building or structure;
- (b) is constructed, erected and installed in accordance with the specifications certified by a professional engineer;
- (c) is equipped with a suitable safety gate or equally effective means of protection from falling, at all access openings in floors, platforms and rest platforms;
- (d) where it is in a vertical position or at an angle of not more than 25 degrees to the vertical, it
 - (i) meets the requirements of the ANSI Standard, ANSI 14.3, **Safety Requirements for Fixed Ladders American National Standard for Ladders – Fixed – Safety Requirement**,
 - (ii) has side rails that extend at least one metre above any platform, roof or other landing on the building or structure to which it is fixed,
 - (iii) has an opening in the platform, roof or other landing that does not exceed 750 mm (29 in) by 750 mm (29 in), and
 - (iv) is equipped, if it is more than 5 m (16 ft) high, with ladder cages and rest platforms, at intervals of not more than 5 m (16 ft), or a fall protection system that meets the requirements of Part 14 (Fall Protection); and
- (e) where it is fixed at an angle of more than 25 degrees to the vertical or more than one horizontal to two vertical, it is equipped with
 - (i) a handrail that extends its entire length and is between 800 mm (31 in) and 920 mm (36 in) above the front edge of the treads,
 - (ii) treads that are level and uniform in width and depth and in the vertical distances between them throughout the length of the ladder, and
 - (iii) on an open side, both a handrail and an intermediate rail or equivalent safeguard.

13.20(2) Clause (1) (c) does not apply to

- (a) a landing that is serviced by more than one fixed ladder; or
- (b) a fixed ladder installed before the coming into force of this regulation.

13.21 Fixed ladders re multi-level buildings

Employers and owners must ensure that a fixed ladder that complies with the requirements of section 13.20 is used to provide access to every level of a multi-level building that is more than 4 m (13 ft) above the preceding level.

ANSI Standard A14.3 – Ladders – Fixed - Safety Requirements

This standard outlines minimum requirements for the design, construction and use of fixed ladders, as well as requirements for cages, wells, and ladder safety systems used with fixed ladders in order to prevent personal injuries.

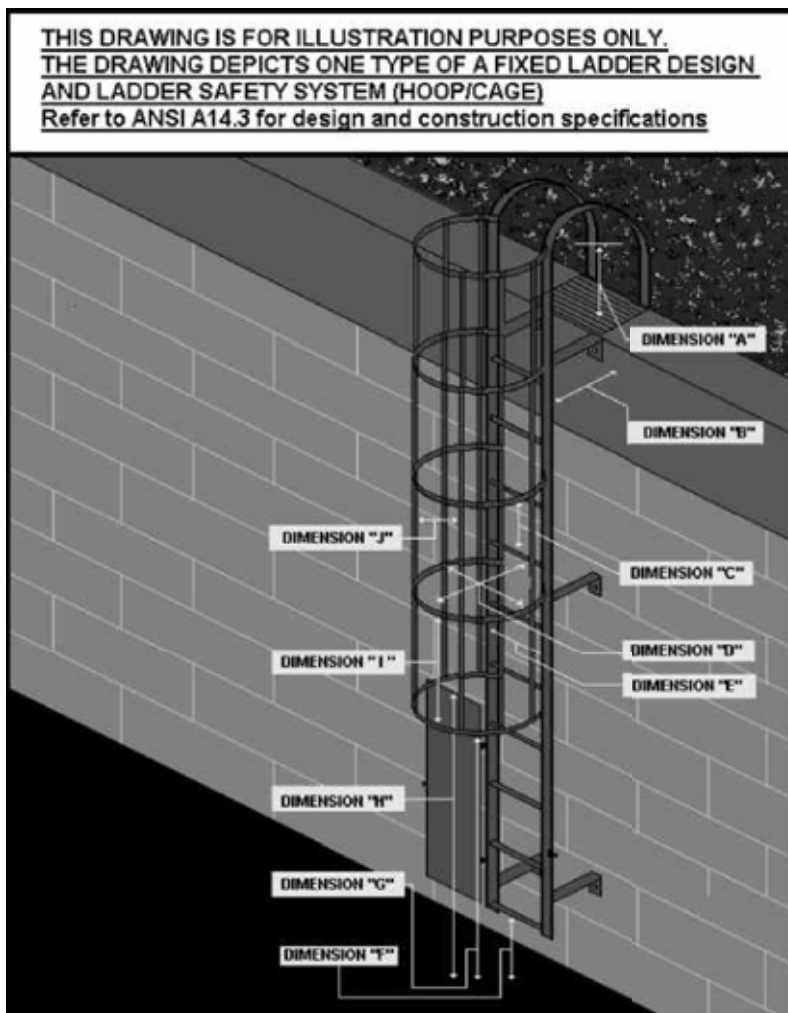

Note: see the Dimension Legend on the next page for more details on the illustration.

DIMENSION LEGEND

- "A" Required distance 3.5 ft (1.07 m) excluding arch.
- "B" Minimum 7 in (18 cm)
- "C" Maximum 12 in (30 cm) between centres, all rungs.
- "D" From centre of rung 27 in - 30 in (68.5 cm - 76.25 cm) and shall not be less than 27 in (68.5 cm) in width
- "E" Minimum 16 in (40 cm) clear width between side rails
- "F" Maximum 12 in (30 cm)
- "G" Cage Hoop shall begin at a height of 8 ft (2.44 m) from grade
- "H" Lockable blank doors to extend high enough to prevent unauthorized access
- "I" Maximum spacing between hoops 4 ft (1.22 m)
- "J" Bands shall be spaced a maximum 40 degrees on centre around the circumference of the cage. This will result in a maximum spacing of 9.5 inches (24 cm)

The surface of the parapet between the handrails of the ladder is to be covered by expanded metal decking, a minimum width of 2ft (0.6m), or other non-skid surface acceptable to inspecting authorities. For multi-level buildings, a fixed ladder is required to provide access to every level that is more than 13 ft (4 m) above the preceding level.

AERIAL DEVICES AND SELF-ELEVATING WORK PLATFORMS

Fall protection systems are required for all workers working from elevated aerial devices. An aerial device is a vehicle-mounted or trailer-mounted telescoping or articulating device that is used to position a worker at an elevated worksite / work position, and includes:

- (a) a work basket or bucket;
- (b) an aerial ladder;
- (c) an extendable and articulating boom platform;
- (d) a vertical tower; and
- (e) any combination of the devices listed in clauses (a) to (d).

A proper fall arrest system, consisting of a full body harness, shock-absorbing lanyard and suitable anchorage, must be part of the safe work procedure developed and implemented by the employer.

Example of the types of systems:

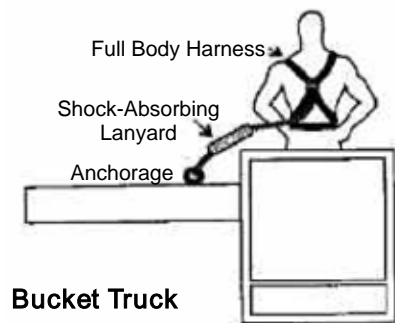

Bucket Truck

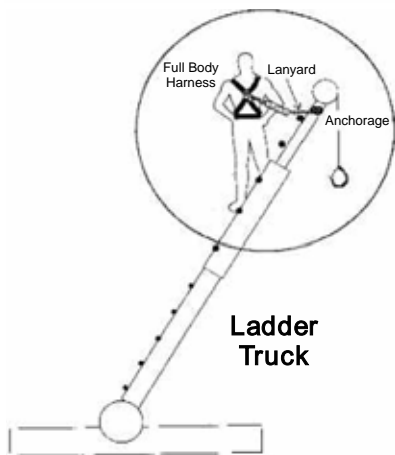

Ladder Truck

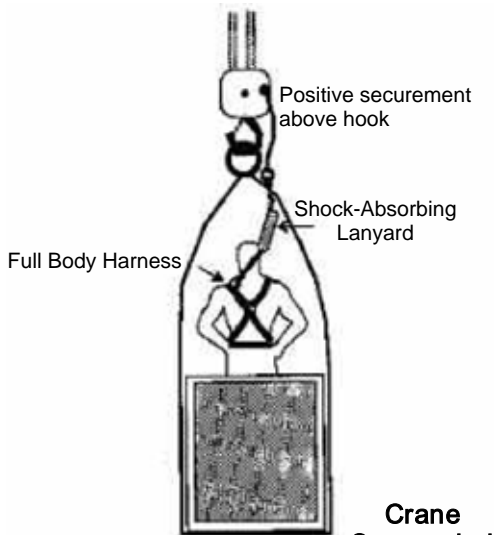

Crane Suspended Work Platform

Standards regarding self-elevating work platforms and aerial devices

Employers must ensure that a self-elevating work platform or aerial device used at a workplace is designed, constructed, installed, maintained, used and dismantled according to the following standards:

- (a) CSA B354.1 “Portable Elevating Work Platforms”;
- (b) CSA B354.2 “Self-propelled Elevating Work Platforms”;
- (c) CSA B354.4, Self-propelled Boom-Supported Elevating Work Platforms”; or
- (d) CSA C225, Vehicle-Mounted Aerial Devices.

Employers must also ensure that:

- a self-elevating work platform or aerial device constructed at a workplace is designed and certified by a professional engineer;
- the professional engineer's specifications for its construction, installation, maintenance, use and removal follow the standards listed above; and
- the manufacturer's specifications for a commercially manufactured self-elevating work platform or aerial device used at a workplace follow the standards listed above.

Employers must ensure that structural repairs and modifications to the components of a self-elevating work platform or aerial device are:

- made only under the direction and control of a professional engineer; and
- certified by the professional engineer that the workmanship and quality of the materials used has restored the components to their original capacity or better.

Scissor Type Powered Platforms:

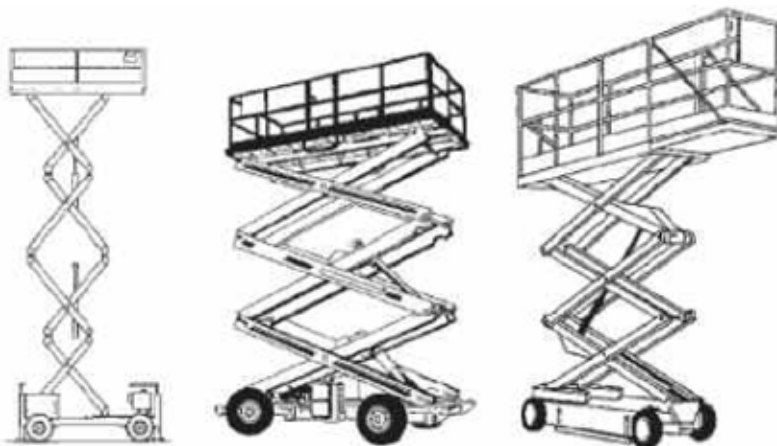

Boom Type Powered Platforms:



Push Around Powered Platforms:



Guarding (Part 28, section 28.38 of M.R. 217/2006)

Employers must ensure that each self-elevating work platform and aerial device used at a workplace is equipped with:

- (a) suitable guards to prevent a worker from contacting the moving parts and machinery, including protection from shearing hazards created by the movement of the platform, and
- (b) guardrails and toe-boards on all open sides or an enclosure that is at least 900 mm (36 in) in height.

Fall protection (Part 28, section 28.39 of M.R. 217/2006)

Employers must ensure that a worker using a self-elevating work platform or aerial device:

- (a) uses a fall arrest system that meets the requirements of MR 217/06 Part 14 (Fall Protection) when
 - (i) the platform or aerial device is being elevated, lowered or moved, or
 - (ii) the worker steps beyond the guardrail; and
- (b) has the lanyard of the fall arrest system attached in accordance with the specifications of
 - (i) the manufacturer of the work platform or aerial device, or
 - (ii) a professional engineer.

28.39(2) An employer must ensure that a lifeline is of an appropriate length to prevent a worker from being ejected from the self-elevating work platform or aerial device if it collapses.

28.39(3) Despite the previous subsection, a fall arrest system is not required for a worker who remains within the confines of the guardrail of a scissor lift while the lift is being raised or lowered unless otherwise required by the manufactures specifications.

Maintenance, records and manuals (Part 28, section 28.40 of M.R. 217/2006)

Employers and suppliers are required to do the following, while a self-elevating work platform or aerial device is in their possession:

- (a) maintain it so that it is safe for use;
- (b) keep a permanent record of all inspections, tests, repairs, modifications and maintenance performed on it; and
- (c) ensure that its operator's manual is kept with it.

28.40(2) A record under subsection (1)(b) must include the name and signature of the person who maintains it and the person who performs an inspection, test, repair or modification on it.

Signs (Part 28, section 28.41 of M.R. 217/2006)

Employers and suppliers of a self-elevating work platform or aerial device must ensure that the platform or device has signs that are clearly visible and legible to an operator at its controls indicating the following:

- (a) the identity of the supplier;
- (b) the name and number of the standard to which the platform or aerial device was designed;
- (c) its rated load;
- (d) all limiting operating conditions, including the use of outriggers, stabilizers and extendable axles;
- (e) the specific firm level surface conditions required for use of the platform or aerial device in the elevated position;
- (f) any warnings specified by the manufacturer;
- (g) except for a boom-type elevating work platform, the direction of machine movement for each operating control.

The CSA standards (listed on page 39) have specific requirements for signage. Refer to the Standard or the Workplace Safety and Health Division's Standard Information Sheet for details.

Climbing prohibited (Part 28, section 28.42 of M.R. 217/2006)

Employers must ensure that no worker climbs on the extension mechanism or the boom of a self-elevating work platform or aerial device.

Use of the self-elevating work platform or aerial device (Part 28, section 28.43 of M.R. 217/2006)

Employers must ensure that a self-elevating work platform or aerial device

- (a) is used only in accordance with the specifications of its manufacturer or those of the professional engineer who designed it;
- (b) is not loaded in excess of its rated load, or loaded or used in a manner that affects its stability or endangers a worker;
- (c) is used only on a firm level surface that complies with the conditions required for its use;
- (d) is not moved unless all workers on it are protected from falling; and
- (e) when elevated, is accessed by a worker only if procedures for doing so have been established in accordance with the manufacturer's specifications or those of the professional engineer who designed it, and then only in accordance with those procedures.

Inspection (Part 28, section 28.44 of M.R. 217/2006)

Employers must ensure that a competent person inspects a self-elevating work platform or aerial device before it is first used and daily when it is in use.

FALL CONTAINMENT SYSTEMS

Safety Nets

Safety nets are most often used when it is not practical to provide a fixed barrier or fall arrest systems at the work site (ex. bridge work; structural steel erection). In these cases, it may be difficult or impossible to install guardrailing or to provide a proper anchoring and lifeline system for fall arrest.

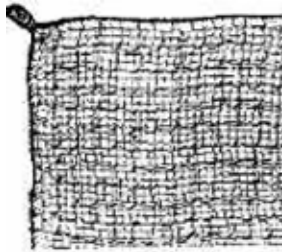

Safety Net and Securement

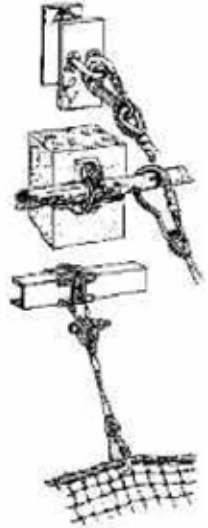

Safety nets must be designed, installed, tested and maintained according to ANSI Standard A10.11. The net must be installed so that it extends at least 2.5 m (8 ft) on all sides beyond the work area and not more than 7.7 m (25 ft) below the work surface.



Inspection and testing of safety nets

If a safety net is used, employers must ensure that a professional engineer or a competent person under a professional engineer's supervision inspects and tests the installation of the safety net before it is made available for use. The net must also be inspected by a competent person before each work shift.

A competent person possesses knowledge, experience and training to perform a specific duty.

CRANE SUSPENDED WORK PLATFORMS

A crane supported work platform is to be used for hoisting workers and their immediate tools **ONLY** (employers may decide to use tag lines in order to minimize lateral move of the platform).

No person is allowed to ride on a suspended work platform until the Workplace Safety and Health Division has been notified and a serial number has been assigned to the project, according to the requirements under section 28.22 of M.R. 217/2006.

General restriction regarding use of cranes

Employers may only permit a crane to be used to hoist a personnel basket or cage if it is not practical to carry out the required work by using a scaffold or other type of elevated work platform (that does not include the use of a crane).

The prior notification requirements apply whenever a crane is used to hoist a personnel basket or cage, regardless of the height of the hoisting operation:

Basket or cage requirements

When a crane is used to hoist a personnel basket or cage, employers must ensure that the personnel basket or cage:

- (a) is designed by a professional engineer, according to CSA Standard Z150 - 98 (R2004), *Safety Code on Mobile Cranes*, and is constructed according to the design drawings prepared by the engineer;
- (b) is equipped with
 - (i) anchor points located above the load hook of the personnel basket or cage for the attachment of a worker's fall arrest system,
 - (ii) a guardrail that meets the requirements of Part 14 (Fall Protection), and
 - (iii) a skid resistant deck;
- (c) has more than one method of suspension or support, and is designed, constructed and maintained so that failure of one method will not cause the collapse of all or part of it;

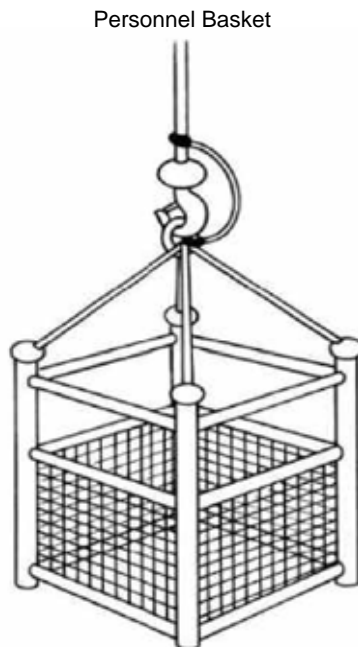

- (d) is designed and constructed so that it remains horizontal at all times;
- (e) is suspended from, or supported by, a direct attachment to the boom of the crane;
- (f) has the following legibly and permanently marked on it in a visible place:
 - (i) the maximum number of workers allowed to occupy the personnel basket or cage,
 - (ii) its weight,
 - (iii) the crane type for which it has been designed,
 - (iv) any other information necessary for safe operation of the personnel basket or cage.

Inspection and certification

Employers must ensure that the professional engineer who designed the personnel basket or cage:

- (a) inspects it before its first use; and
- (b) certifies that it has been manufactured according to design specifications.

Crane requirements and documentation

Employers must ensure that a crane used to hoist a personnel basket or cage:

- (a) is equipped with:
 - (i) fail-safe mechanisms that prevent the boom and the personnel basket or cage from free falling in the event of a power or system failure, or the unintentional release of any operating controls, and
 - (ii) an automatic limit switch that prevents the personnel basket or cage and load from reaching beyond the highest permissible position specified by the crane manufacturer;
- (b) has, on its hoist line, hooks that are equipped with self-closing safety latches at the point where the personnel basket or cage is suspended;
- (c) is not used to hoist material when the personnel basket or cage is being used to support a worker;
- (d) is not loaded in excess of 25% of its rated load; and

- (e) has a clearly visible and legible load chart, revised according to clause (d) by a professional engineer, that is attached in a visible place on the crane

Employers must keep all documents required under the regulation with the crane at all times during a hoisting operation (ex. design drawings, test reports, written statements, certification, etc.).

Operating requirements

If a crane is used to hoist a personnel basket or cage, employers must ensure:

- (a) emergency rescue procedures are developed and implemented for the hoisting operation;
- (b) the workers involved in the hoisting operation are informed of emergency rescue procedures;
- (c) there is an adequate means of communication between workers in the personnel basket or cage and the crane operator; and
- (d) every worker in the personnel basket or cage
 - (i) wears a full body harness that is connected independently to a fixed anchor point located above the crane's load hook, and
 - (ii) uses the harness according to Part 14 (Fall Protection) of M.R. 217/2006.

STEEL ERECTION INDUSTRY

Part 14 of Manitoba Workplace Safety and Health Regulation, M.R. 217/2006 requires workers to be protected from falls when working at heights of 3 m (10 ft) or more.

I-beam used as an anchor point with a sling specifically designed for this purpose

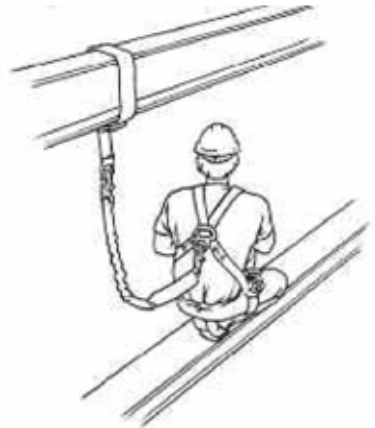

Wire rope used as a horizontal lifeline

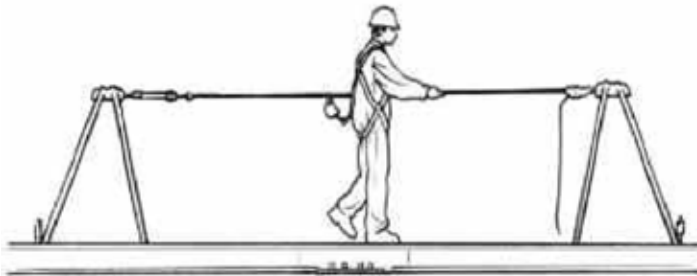

Rigid rail used as a horizontal lifeline



This section provides practical guidance for implementing **fall protection safe work procedures** for workers in the steel erection industry. Users of this guideline should consult the *Workplace Safety and Health Act* and Regulations to ensure they are meeting the requirements of the legislation.

General Principles

A number of general principles apply to protect workers from falls in the steel erection industry:

- All workers must be protected from falls at heights greater than 3 m (10 ft).
- Employers must develop and document a Fall Protection Safe Work Procedure for each project.

- Employers must provide fall protection systems on all projects, including one or more of the following:
 - a) Guardrails / Barriers
 - b) Scaffolds
 - c) Elevating work platforms
 - d) Crane supported work platforms
 - e) Safety nets
 - f) Fall arrest systems

- Workers must wear/use personal protective equipment (fall arrest) provided by the employer, including:
 - Full body safety harness
 - Lanyard
 - Shock absorber
 - Anchor Point
 - Lifeline (Horizontal or vertical)
 - Snap Hook

When carrying out steel erection work, the general principle for fall arrest is that a worker must be connected at all times to the fall arrest system if no other fall protection has been provided. This may mean that workers will be equipped with a double lanyard system, to allow security at all times when moving from one system to another.

Fall arrest systems must be designed to restrict a worker's fall to 1.2 metres (4 ft) or less, and maintain clearance from objects in the event of a fall.

Steel frame building requirements

Part 14 (section 14.28) of M.R. 217/2006 states that *during the construction of a steel frame building, the owner of the building and the prime contractor responsible for the construction of the building must ensure that the structural components of the building designed to accommodate a fall protection system:*

- (a) are designed, approved and certified as safe by a professional engineer; and*
- (b) include*
 - (i) double connections at each column and at beam webs over a column,*
 - (ii) at least four anchor bolts per column, and*
 - (iii) perimeter columns that extend at least one metre above the finished floor to permit the installation of perimeter safety cables.*

Structural connection

When erecting steel structures, the stability of the structure (under construction) poses challenges to workers and employers. Fall protection systems that will be tied into the future structure introduce additional loads to the temporary structure.

When two structural members on opposite column web, or a beam web over a column, are connected and share common connection holes, at least one bolt with its wrench-tight nut must remain connected to the first member.

Diagram 1

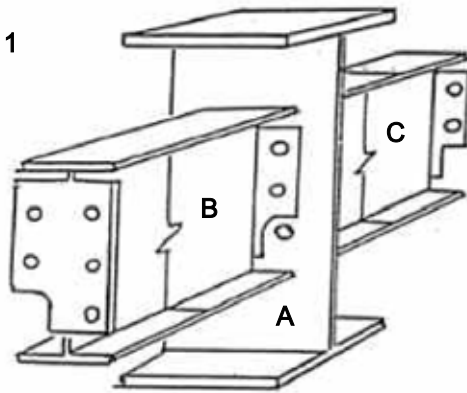

Clipped end connection and staggered connection

Clipped end connections are connection material on the end of a structural member that have a notch at the bottom and/or top to allow the bolt(s) of the first member "A" placed on the opposite side of the central member to remain in place (see Diagram 1). The notch(es) fits around the nut or bolt head of the opposing member to allow the second member to be bolted up without removing the bolt(s) holding the first member.

Diagram 2

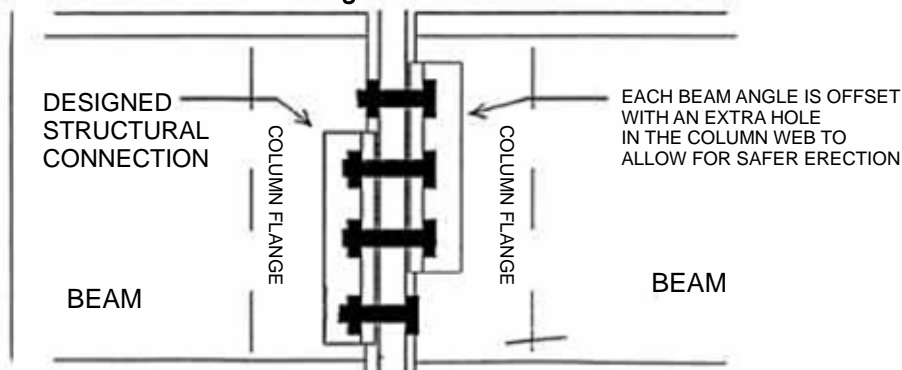

Staggered connections are connection material on a structural member in which all of the bolt holes in the common member web of piece “A” (see Diagram 1) are not shared by the two incoming members (pieces “B” and “C” – Diagram 1) in the final connection. The extra hole in the column web allows the erector to maintain at least a one bolt connection at all times while making the double connection.

Anchorage Points

Lifeline anchors:

If roof-level protection consists of a system of lifeline anchors, employers must ensure:

- (a) each life line anchor is
 - (i) capable of resisting a force of 22.2 kN (5000 lbs) in any direction in which the load may be applied for each worker attached; and
 - (ii) made of stainless steel or other material resistant to corrosion;
- (b) the anchorage system is certified by a professional engineer as having the required load capacity; and
- (c) if an eyebolt is used as an anchor, the interior opening of the eye measures at least 38 mm (1 ½ in).

Anchorage points may consist of rated eyebolts, drilled holes, welded or bolted steel plates, beam clamps, or other devices designed to carry the design load for the fall arrest application. The anchor attachment point should not be the connection bolt holes; it must be a separate anchor system designed for vertical or horizontal lifeline orientation, and capable of carrying the design load 22.2 kN (5000 lbs) force in the anticipated direction of the loading.

Clamp-on type anchors may be used if they meet the requirements above. These anchors must be attached in positions on the structural members according to the design specifications of those members.

Erection procedures

Columns

Before a worker climbs a column, it must be properly secured and a fall arrest system must be provided. The fall arrest system may consist of a vertical lifeline extending from the top of the column to the base or a retractable block device anchored at the top of the column. The fall arrest system should be in place prior to erecting the column so that the worker does not need to climb a ladder or use other means to secure the fall arrest system.

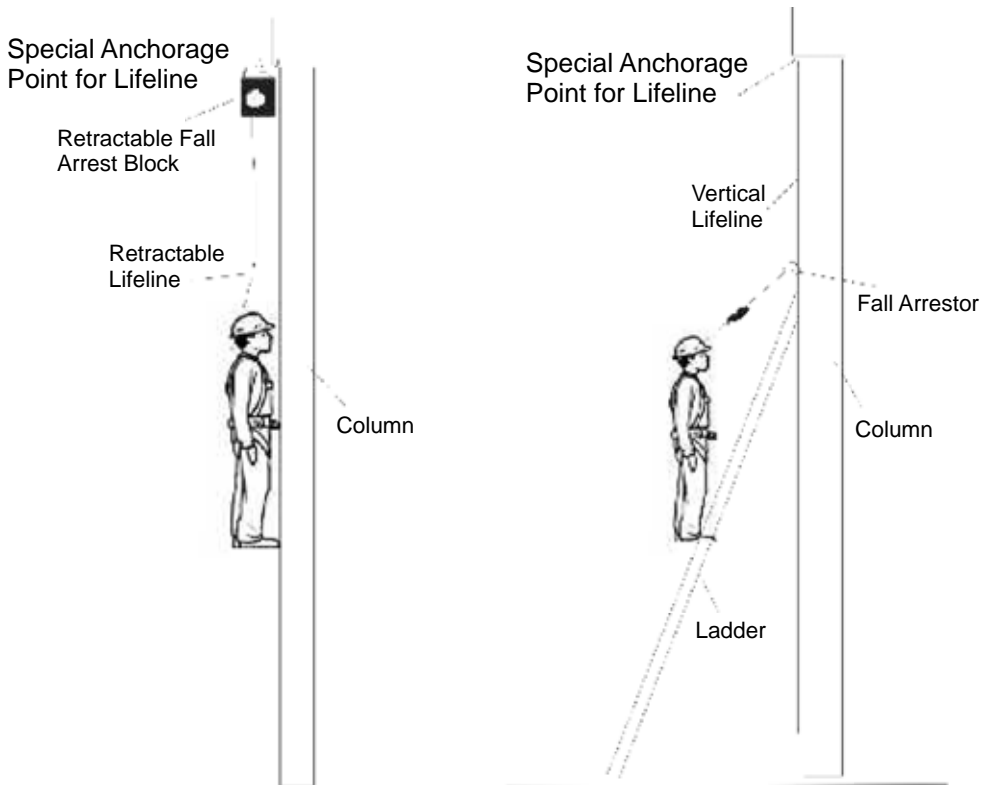

Beams

Horizontal static lines should be installed before erecting steel beams. If horizontal fall arrest systems are installed after erecting, safe work procedures must be in place to protect workers from falling as the systems are installed. This may include using a powered elevating work platform or securing the worker to a column lifeline system, as long as travel distances away from the column do not allow for a large swing radius in case of a fall.

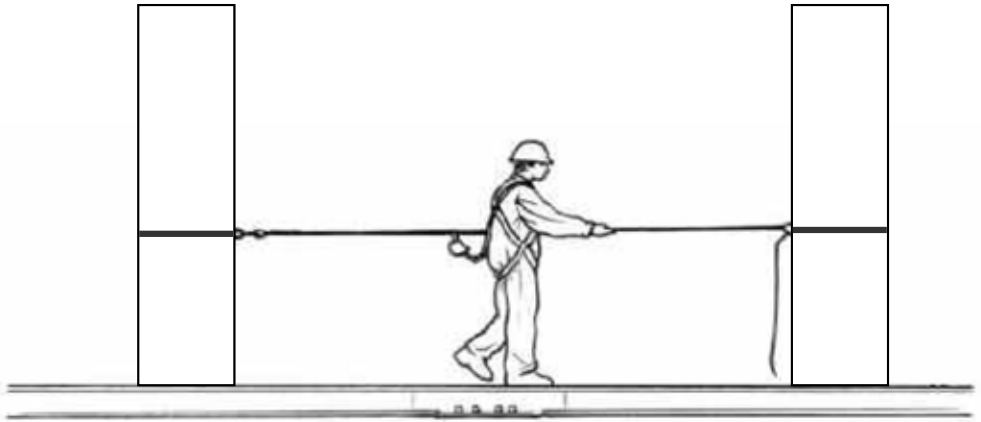

Pre-Engineered Structures

If a horizontal static line will be used for fall protection on a pre-engineered steel building, it must be approved by an engineer and reviewed by the building's designer. Care must be taken to ensure that the anchorage system will not result in structural instability of the building at any point in its erection, should a fall occur.

ROOF WORK

Part 14 of Manitoba Workplace Safety and Health Regulation, M.R. 217/2006 requires workers to be protected from falls when working at heights of 3 m (10 ft) or more.

This section provides practical guidance for implementing Fall Protection Safe Work Procedures for workers in the roofing industry. It cannot cover all situations that may occur on a construction project site, and users of this guideline should consult the *Workplace Safety and Health Act* and Regulation, M.R. 217/2006 to ensure they are meeting the requirements of the legislation.

Special systems and combinations of control measures are required in the roofing industry. Each job must be assessed for the particular fall hazards present, and documented safe work procedures must be developed for each construction project site.

General Requirements

Before any work begins on the roof of a building, employers must ensure that the structure of the building is evaluated and determined to be capable of supporting loads on the roof, including workers, equipment and materials.

General Principles

A number of general principles apply to fall protection for workers:

- All workers shall be protected from falls at heights greater than 3 m (10 ft) or a vertical distance of less than 3 m where there is an increased risk of injury due to the surface or item on which the worker might land:
 - a) into operating machinery or moving parts of the machinery;
 - b) into water or another liquid;
 - c) into or onto a hazardous substance or object, eg. concrete;
 - d) through an opening on a work surface; or
 - e) a vertical distance of more than 1.2 m from an area used as a path for a wheelbarrow or similar equipment.
- Employers must develop and document Fall Protection Safe Work Procedures for each project.
- Employers must provide fall protection systems on all projects, including one or more of the following:
 - a) Floor Opening Protection
 - b) Fall Arrest Systems
 - c) Guardrails
 - d) Warning Barrier/Control Zones

- Workers must wear/use personal protective equipment for fall arrest, provided by the employer, including:
 - Full Body Safety Harness
 - Lanyard
 - Shock Absorber
 - Anchor Point
 - Lifeline
 - Snap Hook

Fall Protection Safe Work Procedures

Employers must develop and implement Fall Protection Safe Work Procedures prior to work starting on a project. Refer to the Division's SAFE Work Bulletin # 249 (3 of 3).

The prime contractor for the construction project site must ensure all sub-contractors provide supervisors safe work procedures prior to the start of the project. Safe Work Procedures must be available at the jobsite for all persons to review.

Safe Work Procedures are to be documented and include:

- responsibilities of supervisors and workers on the project
- fall protection methods to be used
- personal protective equipment to be used
- rescue plan, where applicable

Selection of a fall protection system to control the hazard to the worker depends on the circumstances and the job. The best choice of a fall protection system will be one that removes the risk of falling entirely. For example, it is preferable to provide a guardrail to prevent a worker from falling rather than personal protective equipment (full body safety harness, lifeline, and shock absorber).

Training

Employers must train roof workers in the safe work procedures.

Worker To Comply

Employers must ensure that roof workers comply with the safe work procedures. This includes cooperating with the employer in complying with the safe work procedures.

Determining The Fall Distance

The 3 metre (10 feet) fall distance is measured from the point on the platform, stair, working surface etc. from which a worker may fall, usually measured from the worker's feet, to a lower level. Lower levels include, but are not limited to, those areas or surfaces to which a worker can fall such as ground levels, floors, platforms, ramps, runways, excavations, pits, tanks, material, water, equipment or structures.

On a sloped roof, the 3 metre (10 feet) fall distance is measured in two ways:

- (1) if the worker is upslope from the eave and more than 2 metres (6.5 feet) away from a gable end**, the fall distance is measured from the top of the eave to a lower level. Lower levels include, but are not limited to, those areas or surfaces to which a worker can fall such as ground levels, floors platforms, ramps, runways, excavations, pits, tanks, material, water, equipment or structures. The vertical height from the workers position to the unguarded roof edge must be added when on a roof with a slope greater than 4 vertical in 12 horizontal (4:12 pitch). The vertical distance that a worker may roll or slide down the sloped roof before he or she loses contact with the roof is not considered to be part of the “fall distance”;

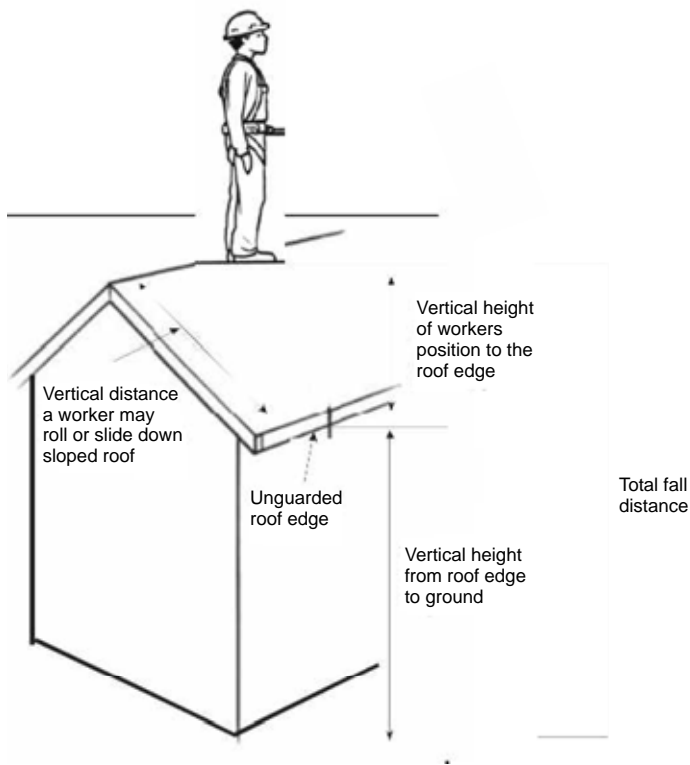

(2) if the worker is within 2 metres (6.5 feet) of a gable end at any point upslope of the eave, the fall distance is taken as the vertical distance from the worker's feet to a lower level. The assumption here is that the fall hazard is the worker falling off the gable end – the worker is much less likely to roll or slide down to the eave and then lose contact with the roof.

In the case of multi-level sloped roofs, for example, if a worker falls from one level to the next, a distance of 3 m (10 ft), and then continues to fall to the next level, an additional 2.5 m (8 ft), the need to provide fall protection is based on the overall fall distance of 5.5 m (18 ft). **The sloped roof onto which the worker falls is not considered to be a safe lower level (i.e. one from which a further fall would be prevented).**

Roof Openings

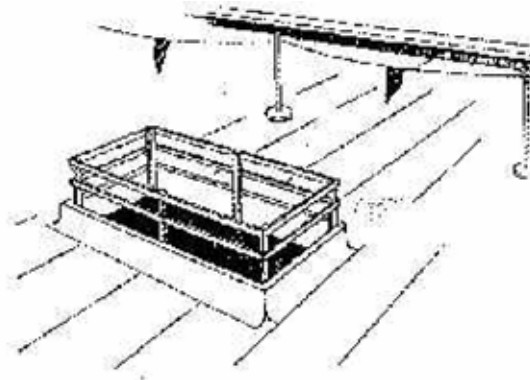

Guardrails must be provided around all roof openings not fitted with permanent or temporary covers.

Temporary covers should not extend more than 150 mm (6 in) beyond the side of the openings they are covering to allow most of the roof work to be completed with the cover in place. Temporary covers must appropriately identify the hazard.

Permanent covers or hatches should remain closed during roofing operations, except when they are used by the roofing crew for access or when they are removed to complete application of felts over the curb on which they are set.

If guardrails around openings or hatch covers are removed to complete the roofing work, the workers must be protected by using a fall-arrest system. The work area should also be roped off and danger signs posted to warn other workers of the hazard.

Work near roof edge

Guardrails

Workers must not work within 2 m (6.5 ft) of a roof edge without using fall protection (travel restraint system) unless temporary guardrails or warning barriers are in place.

Temporary guardrails around the work area must be securely attached to the building.

Workers installing temporary guardrails must use a fall-arrest system if they are closer than 2 m (6.5 ft) to the roof edge. Roof areas not protected by guardrails should be equipped with a warning barrier 2 m (6.5 ft) from the roof edge.

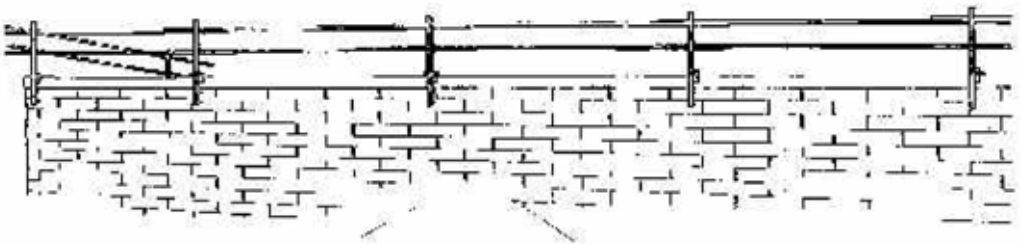
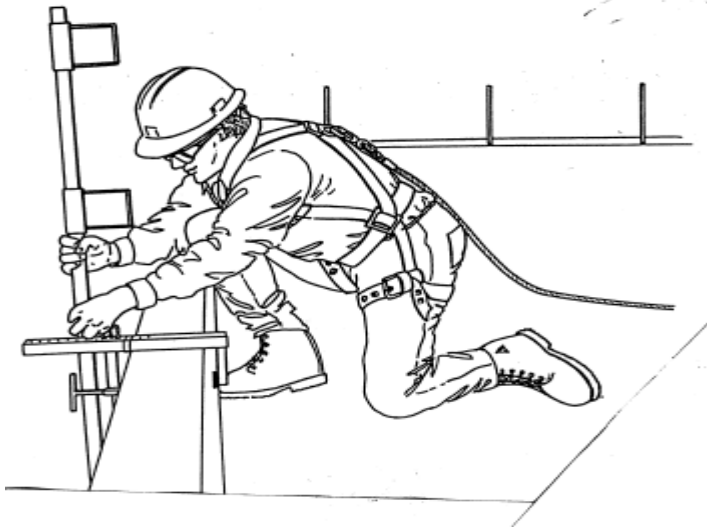

Warning Barriers / Control Zones

Warning Barriers / Control Zones used as alternatives to temporary guardrails must be set up around the work area at least 2 m (6.5 ft) from the perimeter.

For the purpose of this document, the work area is the area where roofing work is taking place, including the removal or application of roofing materials and the delivery, movement, or storage of materials. All of this work may be done without any requirement for fall protection other than the warning barrier itself.

A warning barrier should be between 900mm (36 in) to 1060mm (42 in) in height and as shown in the diagram below, consist of weighted posts for stability and a fibre rope with flags or warning signs.

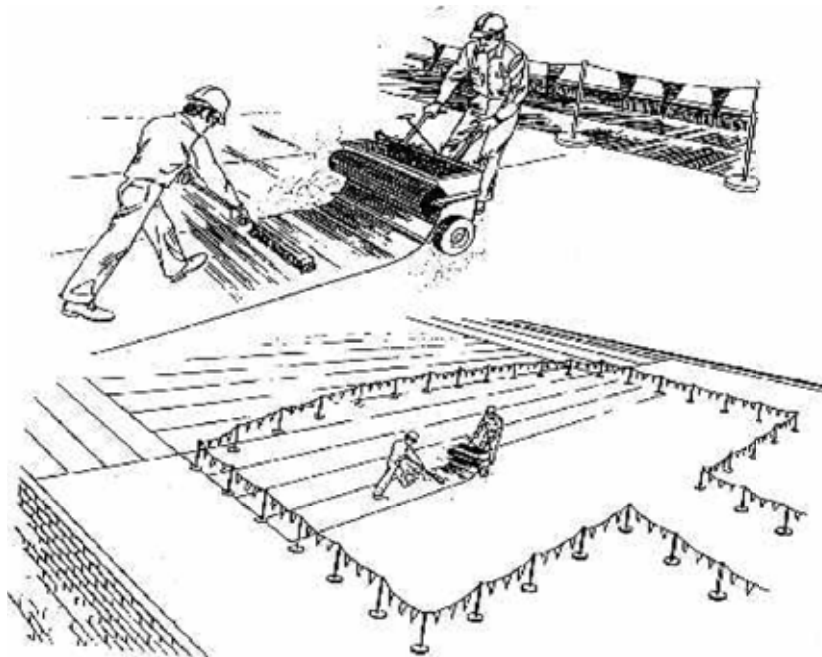

If working outside the warning barrier/control zone, the lifeline of the fall-arrest system must be secured to an anchor. The load exerted by a falling human body is considerable, therefore the anchor must have a minimum capacity for 5000lbs (22kN) force in any direction.

The lifeline should be kept reasonably taut without a lot of loose line between the worker and the anchor. Retractable block lifelines remain taut automatically and are recommended where the line will not come in contact with sticky materials.

The lifeline anchor location should be chosen to minimize pendulum motion in the event of a fall-arrest. This means that the anchor point should be directly behind the worker and **no more than 10 degrees** off each side of the perpendicular line drawn straight back from worker's position. The length of lifeline is not of great concern if the anchor point is kept within this limit.

Lifeline anchorage may consist of either permanent building maintenance anchor points or structural features of the building.

Adequate structural features include large HVAC units, mechanical rooms or roof access rooms.

Never anchor lifelines to small air conditioners, condensers, drain covers, stink pipes, roof hatches, fixed ladders, handrails, or satellite dishes.

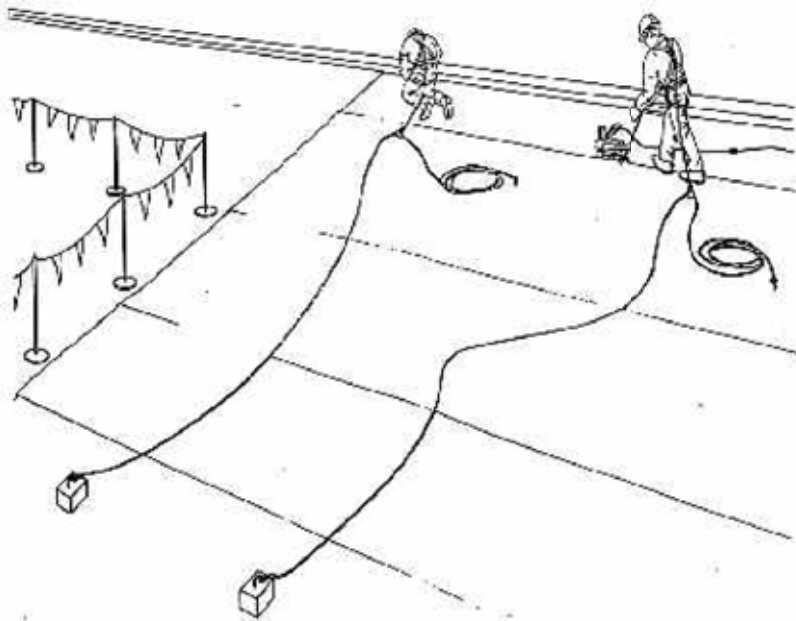

Material Supply

Roofing Hoists

Roofing hoists located at the perimeter must be erected with guardrails which extend at least 900 mm (3 ft) on both sides of the frame and which are set up in accordance with the manufacturer's instructions.

Wherever possible, a roofing hoist should be set up at least 3 m (10 ft) from a corner.

If a hoist has to be set up closer to a corner for proper access, an additional guardrail must be attached to the guardrail on the hoist and a warning line set up.

A roofer's hoist must be erected so that the hoist cable remains vertical at all times while a load is being hoisted. In addition, the hoist arrangement must have a safety factor of no less than three (3) against overturning. (Refer to Part 23 of the workplace safety and health regulation for roofer's hoist requirements.)

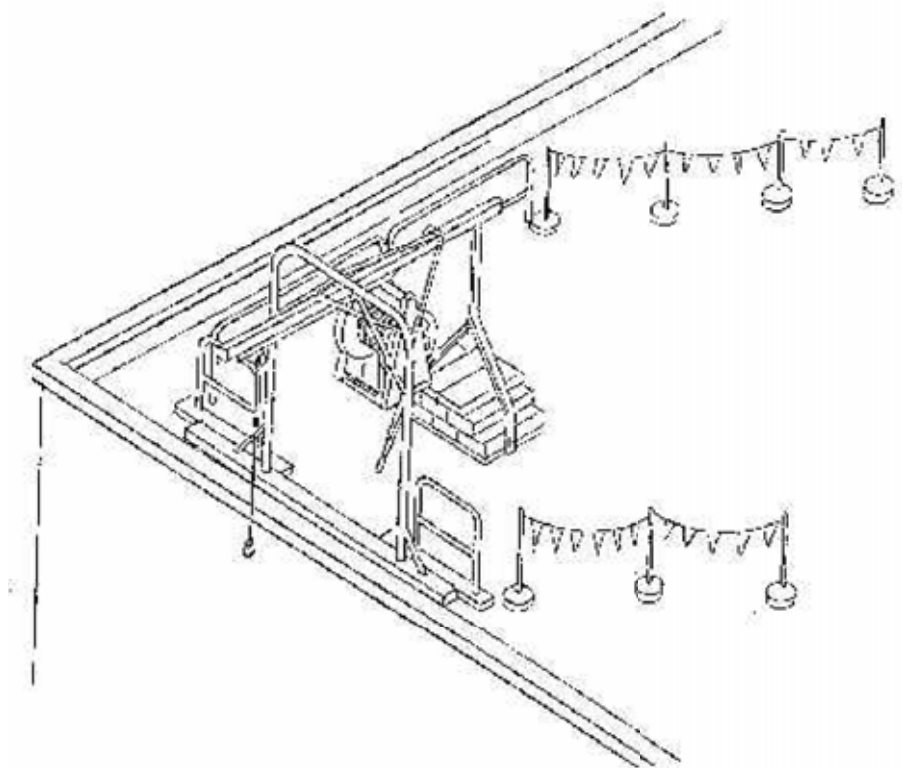

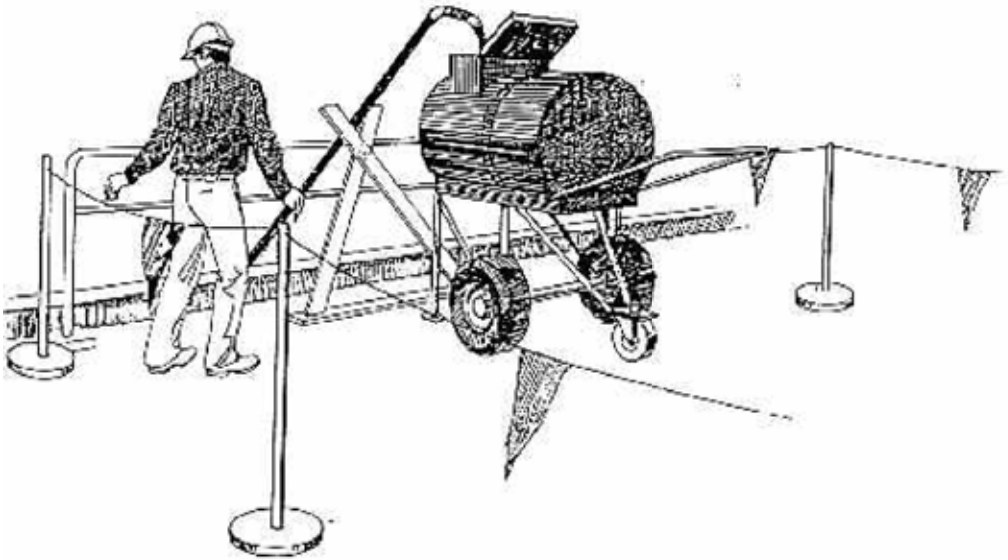

Bitumen Pipe Discharge Area

If hot bituminous material (“hot stuff”) is pumped to the roof and discharged into a hot stuff container or other similar device within 2m (6.5 ft) of the roof edge, a guardrail or barrier should be installed at the roof edge. The pipe supplying the bituminous material should also be properly supported and held in position so that any deflection or movement will not present a hazard to workers on the roof.

The hot stuff container or similar device supplied by the discharge pipe must be fixed or blocked in position and the pipe securely fastened to it.

Ladders for Roof Work

Safety Checklist:

Refer to Part 13 of the workplace safety and health regulation.

- Check the ladder for defects at the start of the shift and after it has been used in other locations by other workers
- Inspect the ladder for structural integrity. Hardware and fittings should be securely attached and free from damage, excessive wear, and corrosion. Movable parts should operate freely without binding or excessive play.
- Frayed or worn ropes on extension ladders should be replaced with a size and type equal to the manufacturer's original rope.
- Aluminium ladders should be checked for dents and bends in side rails, steps, and rungs. Repairs should be made only by the manufacturer or manufacturer's agent.
- The top of the ladder should be tied off or otherwise secured once it is in position.
- If a ladder is used for access from one work level to another, the side rails should extend a minimum of 1 m (3 ft) above the landing.
- All straight extension ladders should be erected at an angle so that the horizontal distance between the top support and the base is not less than one-quarter or greater than one-third the vertical distance between these points.
- Short ladders must never be spliced together to make a long ladder.
- Unless proper barricades have been erected, ladders should not be set up in passageways, doorways, driveways or other locations where they can be struck by persons or vehicles.
- Only one person at a time should be allowed on a single-width ladder.
- Always face the ladder when climbing up or down and when working from it.
- Never climb up or down a ladder while carrying anything in your hands. Tools, equipment, and materials should be placed in a container and raised or lowered by rope.
- Never rest a ladder on its rungs. Ladders must rest on their side rails.
- Contact public utilities if you are working near, or capable of making contact with an overhead power line. (Refer to Part 25 of the workplace safety and health regulation.)

NOTE: Ladders found to be defective should be taken out of service immediately and tagged, "**DANGER DO NOT USE.**"

RESIDENTIAL CONSTRUCTION

“**Residential Construction**” means construction work where the construction materials, methods and procedures are used for single and multiple family dwelling construction projects, and the dwelling is designed with an eave elevation of not more than 6 m (20 ft).

Regulations under the *Workplace Safety And Health Act* require workers to be protected from falls when working at heights of 3 m (10 ft) or greater.

This section provides general guidance in developing and implementing Fall Protection Safe Work Procedures for workers in this industry. It cannot cover all situations that may occur on a project, and users of this guideline should consult the *Workplace Safety and Health Act* and regulations to ensure they are meeting the requirements of the legislation.

Residential construction presents unique circumstances and challenges when it comes to fall protection for workers. Each job must be assessed for the particular fall hazards presented, and a Safe Work Procedure developed.

Safe Work Procedures & Training

Employers must develop and implement Safe Work Procedures for Residential Construction, train workers on the Safe Work Procedures and ensure that workers comply with the Safe Work Procedures. For information on how to conduct a Job Hazard Analysis and how to develop Safe Work Procedures see Safe Work Bulletins 249 (1 of 3), 249 (2 of 3) and 249 (3 of 3).

General Principles

There are a number of general principles that apply to protecting workers from falls:

- All workers shall be protected from falls at heights greater than 3 m (10 ft) or a vertical distance of less than 3 m where there is an increased risk of injury due to the surface or item on which the worker might land:
 - a) into operating machinery or moving parts of the machinery;
 - b) into water or another liquid;
 - c) into or onto a hazardous substance or object, eg. concrete;
 - d) through an opening on a work surface; or
 - e) a vertical distance of more than 1.2 m from an area used as a path for a wheelbarrow or similar equipment.
- Employers must develop and document Fall Protection Safe Work Procedures for each construction project site.

- Employers must provide fall protection systems on all projects, which shall include one or a combination of the following measures:
 - a) Guardrails and/or Warning Barriers / Control Zones
 - b) Floor Opening Protection
 - c) Travel Restraint and
 - d) Fall Arrest Systems

- Workers must wear and use Personal Protective Equipment (Fall Arrest) provided by the employer which shall consist of the following:
 - Full Body Safety Harness
 - Lanyard
 - Shock Absorber
 - Anchor Point
 - Lifeline
 - Snap Hook

Fall Protection Safe Work Procedures

Due to the complexity and variation in projects, it is required that a Fall Protection Safe Work Procedures be developed by the employer prior to work commencing on the project.

The Safe Work Procedure is to be documented and include:

- responsibilities of supervisors and workers on the project
- erection or dismantling plans and sequence of activities
- fall protection methods to be used
- engineering design requirements
- personal protective equipment to be used
- rescue plan

The Safe Work Procedure must be available at the jobsite for all to review and consult.

The selection of the particular fall protection system to control the hazard to the worker is dependent upon the circumstances and the job task. Ideally, the choice of a protection system will be one that removes the risk of falling entirely. For example, it is preferable to provide a fixed barrier to prevent a worker from falling, than personal protective equipment (full body safety harness and lifeline). In this way, the worker is never in a position where an actual fall may occur. Otherwise, the worker must rely on the personal protective equipment system to safely arrest the fall.

Changes to the Safe Work Procedure

Employers must designate a competent person to approve changes to the Safe Work Procedure. The competent person must review the safe work procedures as the job progresses and determine if additional practices, procedures, or training need to be implemented.

In the event of a fall or other serious incident, the employer must ensure the hazard and risk assessments are re-evaluated to ensure additional control measures are implemented.

Reminder: all serious incidents as defined in Part 2 of the workplace safety and health regulation must be reported to the Workplace Safety and Health Division.

Employers must notify and train workers if new procedures are implemented. Documented training records must be available for all persons engaged in the activity.

Site Specific Safe Work Procedure Interpretation

Fall protection safe work procedures need not be singularly site specific for residential construction but must apply to the site and structure, and contain only applicable information. However, a unique site and or structure will require a site specific safe work procedure.

For residential construction, the requirement for site specific fall protection safe work procedures allows a residential builder who builds almost identical structures on multiple sites to have one, two or several standardized safe work procedures for many structures. An all-encompassing, “canned” safe work procedure, containing material that does not apply to the structure under construction, is not acceptable.

Determining The Fall Distance

The 3 metre fall distance is measured from the point on the platform, stair, working surface etc. from which a worker may fall, usually measured from the worker's feet, to a lower level. Lower levels include, but are not limited to, those areas or surfaces to which a worker can fall such as ground levels, floors, platforms, ramps, runways, excavations, pits, tanks, material, water, equipment or structures.

On a sloped roof, the 3 metre fall distance is measured in two ways:

- (1) *if the worker is upslope from the eave and more than 2 metres (6.5 ft) away from a gable end***, the fall distance is measured from the top of the eave to a lower level. Lower levels include, but are not limited to, those areas or surfaces to which a worker can fall such as ground levels, floors platforms, ramps, runways, excavations, pits, tanks, material, water, equipment or structures. The vertical height from the workers position to the unguarded roof edge must be added when on a roof with a slope greater than 4 vertical in 12 horizontal (4:12 pitch). The vertical distance that a worker may roll or slide down the sloped roof before he or she loses contact with the roof is not considered to be part of the “fall distance”;

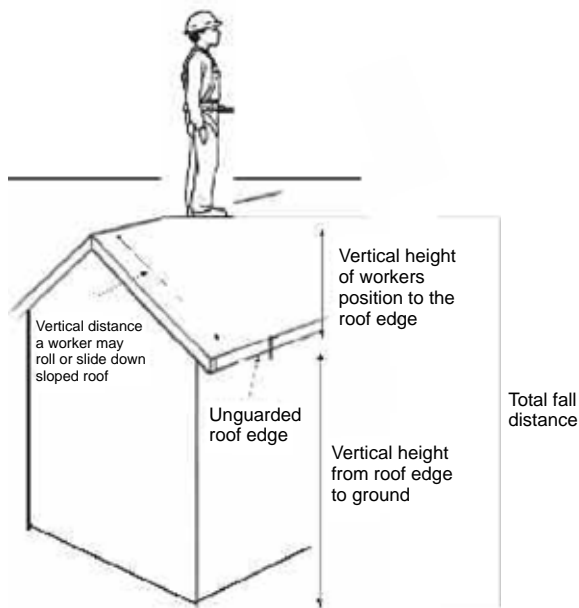

(2) if the worker is within 2 metres (6.5 ft.) of a gable end at any point upslope of the eave, the fall distance is taken as the vertical distance from the worker's feet to a lower level. The assumption here is that the fall hazard is the worker falling off the gable end – the worker is much less likely to roll or slide down to the eave and then lose contact with the roof.

In the case of multi-level sloped roofs, if a worker falls from one level to the next, a distance of 3 metres for example, and then continues to fall to the next level, an additional 2.5 metres for example, the need to provide fall protection is based on the overall fall distance of 5.5 metres. **The sloped roof onto which the worker falls is not considered to be a safe lower level (i.e. one from which a further fall would be prevented).**

Procedure Based Fall Prevention Controls

This section allows the use of another control measure considered by the Director (A.D.M.) of the Workplace Safety & Health Division. This system involves the use of administrative procedures, in the limited number of situations **only** described below, subject to specific conditions. A procedure-based fall prevention control can only be used in the following situations, where workers are exposed to fall hazards for very short periods of time, not more than 20 minutes:

(1) installation or removal of fall protection equipment (first person up/last person down) – typical examples may involve installing a fall arrest anchor at the peak of a roof, and removal of fall protection anchors.

- (2) **roof assessment or estimating** – applies to both flat and sloped roofs. Roof assessment includes school staff checking for and retrieving items that have been thrown on a school roof; insurance estimators; roof repair estimators, etc.
- (3) **emergency repairs** – this does not include normal maintenance and service tasks. Emergency repairs must involve light duty tasks of short duration, not more than 20 minutes.

If an employer wishes to use a procedure-based fall prevention system, all of the following conditions must be met:

(1) Documented Hazard Assessment

A written hazard assessment specific to the work site and work being performed must be completed as required under Section 4(2)(c) of the Act (see Safe Work Bulletins 249(1-3)).

(2) Documented Safe Work Procedures

The procedures must be documented and effectively communicated to workers before the work begins, and followed by workers while performing the work. Workers must be trained in the safe work procedures and understand the activity they are about to undertake. The procedure based controls must be part of the safe work procedures required by Part 14.2(1) of the workplace safety and health regulation and the fall protection safe work procedures outlined on page 54 of this guideline.

(3) Fall protection system must be used where practical

If the use of a fall protection system such as:

- (a) a guardrail
- (b) a safety net
- (c) a travel restraint system,
- (d) personal fall arrest system,
- (e) a warning barrier / control zone

is practical, it must be used (ex. if anchor points are available or a fall protection system can be rigged without exposing workers to a greater hazard, then a fall protection system must be used). The option of using a procedure based system is not intended to allow an employer or worker to avoid using a fall protection system or some type of elevated work platform just because doing so may be inconvenient or take more time than using an administrative procedure.

(4) Limit number of workers exposed to fall hazard

The work must be carried out in such a way that minimizes the number of workers exposed to the fall hazard while work is performed.

(5) Limit worker exposure to undue harm

Use of a procedure-based control must not expose a worker to undue harm.

Working at height has inherent risks. Undue harm involves exposing a worker to greater potential harm and is not an acceptable practice (ex. having a worker free-climb a steeply sloped metal clad roof to install an anchor at the peak, or having a worker inspect a difficult-to-access equipment location that could be inspected from another location using other means such as an elevating work platform).

The work must not expose workers to undue hazards resulting from poor environmental conditions (ex. high winds, icy footing, roof slope, or surface finish).

(6) Light duty tasks of short duration

The work must be limited to light duty tasks of short duration. As with work performed from a portable ladder, certain conditions apply:

(a) the work must be a “light duty task” such as inspection, estimating, or simple emergency repairs (ex. membrane repair on a flat roof, shingle repair, etc.). The repair of insulation below the waterproofing membrane is not a light duty task.

The work done must be completed within 20 minutes, and

(b) while doing the task, the worker should not turn his or her back to the edge and must keep the edge in sight. If either of these conditions cannot be met, a procedure-based control cannot be used.

(7) Worker competency

The worker performing the work must be trained and knowledgeable in the task.

(8) Limitations on roof assessment/estimation activities

If the procedure-based approach is used for assessment/estimation activities, the activities must take place prior to the actual start of work or after work has been completed. If the activities take place while work is going on (ex. during construction of a roof or structure), the fall protection requirements under Part 14 of the workplace safety and health regulation apply to all workers exposed to a fall hazard.

A procedure-based fall prevention control meeting the listed conditions and applied to the three situations described earlier i.e. (1) installation or removal of fall protection equipment; (2) roof assessment or estimating; and (3) emergency repairs, are activities that will be considered by the Director of Workplace Safety & Health Division for a variance of Part 14 of M.R. 217/2006.

Site Specific Fall Protection Requirements

Working on top of foundation walls and formwork

Workers pouring concrete are required to be in close contact with the distribution chute of the concrete pumper truck. Walking along the top of the form is not acceptable practice; work platforms and scaffolds are recommended to be used.

Work platforms (engineered bracket scaffolds) are made of planks resting on metal brackets that hang from the wall forms.

These platforms must be at least 500mm, 2 -2x10 planks. Planks should overhang the brackets by between 150 mm and 300 mm (6 to 12 inches); have cleats to prevent slipping; and have guardrails (top rail & mid rail) if the platform is over 3m (10 ft) high.

Safe access must be provided to all work platforms. If ramps are used they must meet the regulatory requirement (600mm in width, 1:3 slope, securely fastened in place, supported, cleated, clear of snow & mud accumulation, and when the ramp is placed over a trench it must have hand rails securely fastened in place). Ladders can also be used as an alternate form of vertical access.



Working atop unsheathed floor joists.

- o A misstep is likely to cause a fall to the level the worker is standing or walking on, or possibility through the floor joists.
- o Do not walk on the top of the wall to place the beams. The first floor joists or trusses should be placed into position and secured either from the ground, ladders, safe work platforms or scaffolds.
- o When stacking materials on joists, make sure to distribute the load evenly and near locations of solid support.
- o Use a work platform to install blocking / bridging from below before putting sheathing on joists.
- o Except for the first row of sheathing, which must be installed from the ladders or the ground, workers must work from an established deck.
- o After the first row of sheathing is installed, erect guardrails or place anchorage points in appropriate locations for employees to use personal fall-arrest systems while completing the decking operation.
- o A sheet of plywood acts like a sail in windy environmental conditions. A gust of wind may take it and you over the edge. If wind gusts exceed 35 kilometers per hour, sheathing operations must cease.



- o Fall hazards increase when a worker moves near the perimeter of the structure or near a large floor opening. Floor and roof openings through which a worker could fall must be securely covered or have guardrails erected around them. Ensure floor openings are covered, secured and well marked. Cover floor openings securely and identify them clearly. Ensure all exterior walls have guardrails.



Examples of markings on a plywood cover.

Erecting Second Story Exterior Walls

Guardrails: This method requires workers to attach guardrails to the main floor walls before they are erected. Use a $\frac{1}{2}$ - $\frac{3}{4}$ inch shim between the guardrail and the wall. This forces the guardrails onto a slight angle which allows the 2nd story walls to be erected without interfering with the attached guardrail. Once the main floor walls have been secured in place the second story guardrails will also be in place. Remember, when it's windy, lifting walls can be dangerous. The wind can blow an entire wall section on top of you, or blow you and the wall over the edge. When wind gusts exceed 35 kilometers per hour, alternate control measures may be required to eliminate the risk of worker injury.

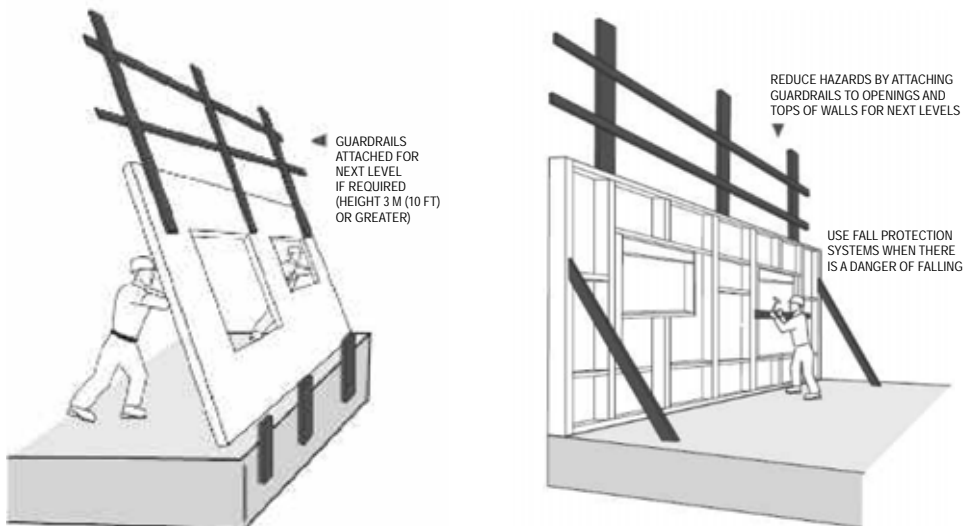

Warning barriers / control zones: This system must be delineated 2 m. (6.5 ft) from all perimeter sides of the structure (see page 58, 59 Work Near A Roof Edge: Warning barriers / controlled access zones). A control zone **cannot** be used if the level working surface on which work is being performed is less than 4 metres (13 feet) wide. In such circumstances, one of the other methods of fall protection required by the fall protection guideline must be used.

Employees must be trained so that they can work inside these lines without fall protection. However, when work is required outside of the warning barrier, a travel restraint system is required. An example would be where most of the wall being built would be inside the control zone but one employee would be responsible for nailing the bottom plate. That employee will be outside the control zone and would be required to use a fall protection system. The bottom plate should be toe nailed for stability while raising the wall.

The wall would be raised using 2x4 boards nailed to the sides of the walls. Once the wall is erected the boards used to raise the walls would be nailed to the floor to brace the wall while the bottom plate is being nailed into the floor.

Fall protection (travel restraint or fall arrest): where guardrails or warning barriers can not be used, travel restraint or fall arrest equipment must be used. At no time is it considered acceptable to work without the use of some type of fall protection system.



After all exterior walls are raised and braced; the window and door openings that are less than 0.9 m (36 inch) from the floor must have guard rails installed at the appropriate height (this may be done while the wall unit is on the floor). Any large openings such as stairwells, atriums, etc. should have permanent walls installed and/or guardrails built.

This process continues until all exterior walls are erected and then the walls will act as fall protection for employees.

Setting Roof Trusses

The safest method of truss installation involves building all or part of the roof on the ground, then hoisting it into place. This is the safest method for truss installation. If your construction project site has the space available for this type of installation, building the roof on the ground should be considered the first

method of choice.

If space limitations do not allow for building on the ground first, placing each truss individually or in a bundle on top of completed wall framing is another method that can be used. Trusses must be spread and erected from scaffolding placed inside or outside the exterior walls of the building.

Before placing trusses, make sure that all floor openings are covered and that walls are braced as required. Remember: **Never stand or walk on the top plate without fall protection.**



Conventional scaffolding, wood scaffolding or engineered bracket scaffolds that hang off the top plate are some examples of work platforms that can be used. Bracket scaffolding, when designed and manufactured correctly, provides a platform and guardrails that comply with the regulations. The platform shown on the next page not only protects the workers from falls - it also reduces back strain by positioning the work at waist level instead of at the feet. Install a temporary platform down the centre of the house to give workers a better position to spread and stand up the trusses. A designed, job-built platform or a frame scaffold system can be used.

Wood scaffolding:



Bracket scaffolding:



The truss system is designed to operate as a complete system, therefore utilization of a truss as a personal fall arrest system attachment point before the system is complete could lead to truss failure/collapse, and result in injuries.

Note: Truss manufacturers state that all permanent bracing has to be installed for the system to be structurally sound. Therefore, prior to using the system for fall arrest anchorage, all permanent braces must be installed in accordance with the truss manufacturer's specifications.

All fastening of trusses to wall top plates must be performed from approved scaffolding inside or outside the walls or from ladders. No worker is allowed to stand on the top plate of the wall. After the last truss is installed, all permanent bracing must be installed prior to starting the sheathing of the roof.

After the permanent bracing is installed, the first row of sheathing must be installed from wall scaffolding or other safe means including scaffolds, elevated work platforms, etc.. Once the first course of sheathing is installed, the truss system can be utilized for personal fall arrest system attachment points. Fall arrest systems must be used for all remaining work on the roof (sheathing, shingling, eaves trough installation, etc).

Piggy-back trusses can only be installed after the main roof structure is complete, including all permanent bracing and sheathing. Piggy-back trusses must be installed utilizing fall arrest systems.

It is strongly recommended to secure anchor systems, such as “snappy strap/ roof bracket” on the fifth truss for a tie off before it leaves the ground and others (at 10 foot intervals) as necessary throughout the house. Most probable locations are the centre truss and fifth from the end.

Example of placement of anchors on a gabled roof:

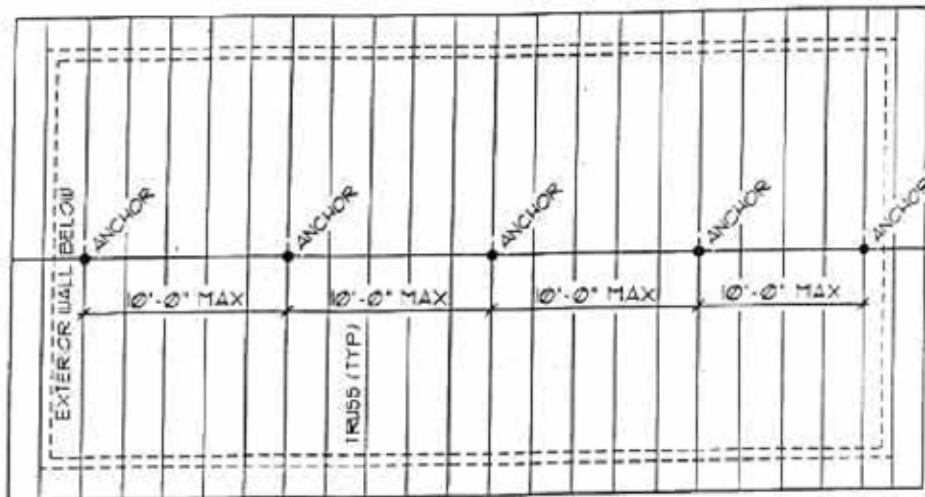

Roof anchors must not be less than 19.9 metres (65 feet) from roof edge.

Fall arrest system secured to an anchor point on a sloped roof

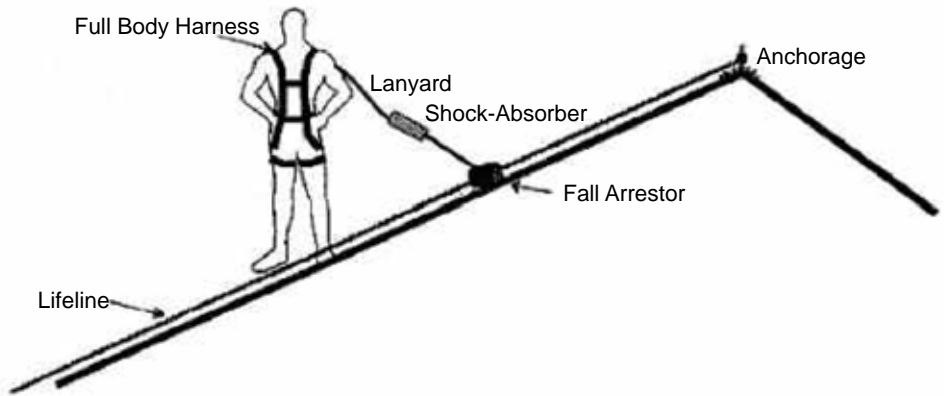

Installing Roof Sheathing

After all trusses have been installed and braced according to manufacturer's specifications, install the first row of sheathing from the interior / exterior scaffolding. Once the first row of sheathing has been installed work can continue from the roof.

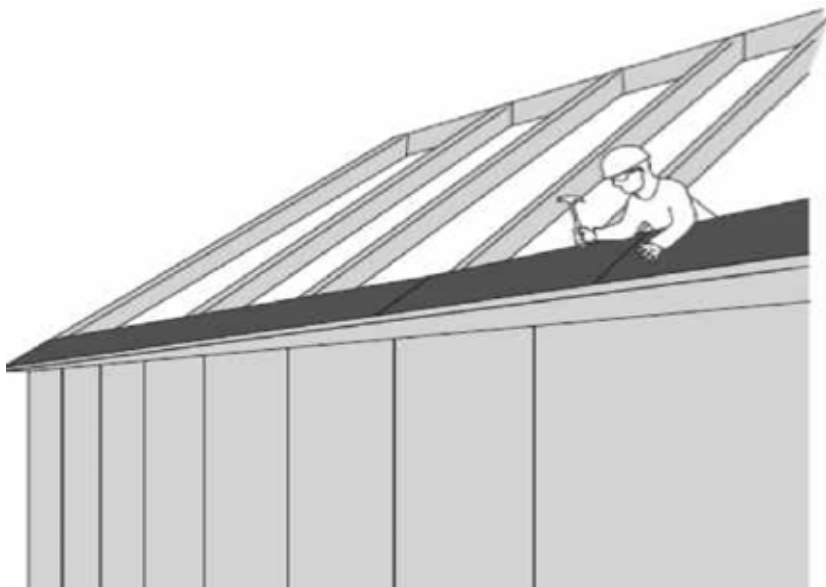

You must ensure 100% fall protection for the remainder of the sheathing process. The first choice of fall protection for sheathing should be guardrails. If this is not possible a fall arrest system must be used. The fall arrest system for sheathing includes a full body harness, shock absorbing lanyard, rope grab, lifeline and anchor. Tie off to anchors on the roof such as ridge brackets or straps. These anchor systems should have been installed during the truss installation. If there are no anchors in place, a competent worker must install the anchors. All anchor points and life lines must be installed across the peak of the roof before commencing sheathing. All lifelines must extend to ground level. When moving from one anchor point to the next, approach the next lifeline, hold both lifelines together, remove rope grab from one and re-connect to the next, or use a “Y” lanyard and tie off to the next before unhooking from the last.

To minimize swinging in case of a fall, ensure the lifeline is no more than 15 degrees to each side of the anchor point.

Attach the rope grab to the life line and climb the ladder to access the roof area. Work from the first row of installed sheathing and continue to complete the roof sheathing requirements.

It is highly recommended leaving the anchor points (only if using anchor straps) for the roofer and other trades who require access to the roof area to complete their work.

Air lines and extension cords are always slip and trip hazards. But on a sloped roof, even a minor slip can lead to a fall. Rather than running cords and lines across the roof, bring them up from directly below the work area. Don't let sheathing lie loose on the roof. Fasten sheets as soon as you place them.

In cold or wet weather - and especially on frosty mornings - wood surfaces can be very slippery. Even though you are secured by your fall protection system, a slip can still injure you. Take care and move cautiously. During times of snow fall, ensure the roof area is swept off on a regular basis to reduce slippery surfaces.



Sloped roofs

Devices such as slide guards (toe boards / roof jacks) and approved ladders with roof hooks are considered helpful on sloped roofs where foot traction is inadequate. They are not considered adequate substitutions for fall protection systems but can be used in addition to fall protection while working on sloped roofs.

Shingling – new construction

Shingling on new construction projects requires 100% fall protection. Workers must tie off to anchors on the roof such as ridge brackets or straps. If there are no anchors in place, a competent worker must install all anchors and lifelines across the peak of the roof before starting work. When moving from one anchor point to the next, approach the next lifeline, hold both lifelines together, remove rope grab from one and re-connect to the next, or use a “Y” lanyard and tie off to the next before unhooking from the last.

To minimize swinging in case of a fall, ensure your lifeline is no more than 15 degrees to each side of your anchor point.

Attach the rope grab to the life line and climb the ladder to access the roof area. Air lines and extension cords are always slip and trip hazards. But on a sloped roof, even a minor slip can lead to a fall. Rather than running cords and lines across the roof, bring them up from directly below the work area. Don't let sheathing lie loose on the roof. Fasten sheets as soon as you place them.

In cold or wet weather - and especially on frosty mornings - wood surfaces can be very slippery. Even though you are secured by your fall protection system, a slip can still injure you. Take care and move cautiously. During times of snow fall, ensure the roof area is swept off on a regular basis to reduce slippery surfaces.

Soffit, Fascia, Eaves Troughing and Siding Application

The installation of soffit, fascia, eaves troughing and siding may require unique fall protection applications. Ladders should be used for short-term work only and should never be used for installing large pieces of siding, eaves troughing, etc. as workers are unable to maintain 3 point contact when climbing the ladder. Ladder jacks, pump jacks, scaffolding or elevated work platforms should be considered the safest method for installation of soffit, fascia, eaves troughing or siding.



*Unsafe practice.
Difficult to coordinate
movements and
impossible to maintain
3-point contact.*

All four of these applications require either guardrails or travel restraint when working above 3m meters or when working over hazardous substances or materials.

Pump-jack scaffolds provide a safe, stable work platform, but you must follow the manufacturer's instructions on inspection, installation, and use.

When using ladder jack scaffolds, make sure that ladders used are properly set up: the base must be 1 foot out for every 3 to 4 feet up. Both ladder feet must rest firmly on the ground and the top side rails must rest firmly against the building. Ladders must also be secured in place to prevent lateral movement and to prevent the ladder from sliding out at the bottom. If the ladder rocks, it's not safe. Ensure the jacks rest on both the side rails and the ladder rungs, or the ladder rungs only, but only if the bearing area of each rung is at least 254 mm (12 in.). Ladders should not be spaced more than 2.5 m (8 ft.) apart and can not be used more than 5 m (16 ft.) above grade. Work platforms must be 500 mm (20 in.) wide.

To access the platform , use a ladder that is properly set up and secured.

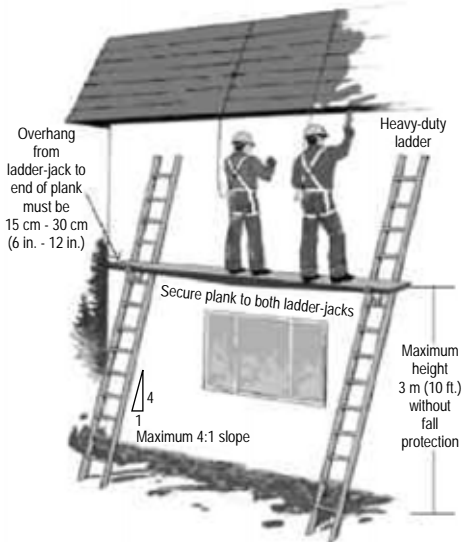

Fall protection is required on ladder-jacks over 3 m (10 ft.).

Make sure the scaffold has suitable guardrails at each end and at the open side of the platform. If there are no suitable guardrails, workers must be provided with, and use, fall protection that includes anchor points secured to the house.

Reminder, if powered elevating work platforms are used, workers must be trained to operate the class of equipment they will use. If elevating work platforms are equipped with anchors, travel restraint protection must be worn while operating the equipment.

A powered elevating work platform lets you lift material, reach the work area efficiently, use both hands for installation, and keeps you from falling.



Working alone in residential construction

On homebuilding sites, trades-people are sometimes required to work alone or in isolation. A worker is considered to be working alone when the worker is:

- o the only worker for that employer at that workplace; and
- o not directly supervised by the employer or another person designated as a supervisor.

Working in isolation means working in circumstances where assistance is not readily available in the event of an injury, illness or emergency.

If workers are required to work alone or in isolation, employers must:

- o identify all risks to workers and take steps to eliminate or reduce those risks;
- o develop and implement safe work procedures:
 - train workers in those procedures and ensure they comply,
 - include an effective communication system as part of the safe work procedures,
 - provide emergency supplies to the worker (ex. under extreme cold or other inclement weather conditions, etc.) where the need is identified,
 - post a copy of the safe work procedures in a visible location at the workplace, and
 - review and revise the procedures regularly.

See the Workplace Safety and Health Division's Code of Practice for Working Alone or in Isolation, and Part 9 of the workplace safety and health regulation for detailed requirements.

Have a plan in case of an emergency

Part 14, section 14.2 (3)(c) of the workplace safety and health regulation requires documented rescue procedures to be in place for use, in the event a rescue is attempted to retrieve a worker after a fall has been arrested.

The suspended worker faces several problems:

- (1) the worker is suspended in an upright posture with legs dangling;
- (2) the safety harness straps exert pressure on leg veins, compressing them and reducing blood flow back to the heart; and
- (3) the harness keeps the worker in an upright position, regardless of consciousness.

Rescue must happen quickly to minimize the dangers of suspension trauma. Time is of the essence because the suspended worker may lose consciousness in as few as five minutes. There are two ways in which a worker may be rescued:

Rescue – this is a simple rescue plan. In this situation the worker has fallen and is hanging from a fall protection system and must not have suffered any type of injury. Equipment that may be used to reach a suspended worker and get them down quickly include: nylon or rope rescue ladders, extension ladders, man-lifts, elevating work platforms, etc.

Ensure that you have a means of communication in the event of a fall. If you are using a cell phone as part of your rescue plan ensure that it is placed in an area where it will be accessible. When a fall occurs, straps across the groin area will prevent a worker from accessing their front pockets.

Injured Casualty Rescue – In this situation the worker has fallen, is hanging from a fall protection system and has suffered an injury that makes a self-rescue impossible. These types of rescues may need specially trained and equipped personnel. This type of rescue requires a much wider selection of equipment and is much more difficult and complex to perform. In extreme cases, the fire department may use aerial ladder trucks, high-reach equipment or rappelling techniques to reach trapped workers and lift or lower them to a safe level.

Rescue plans should cover the on-site equipment, personnel, and procedures for different types of rescue. Any off-site rescue services that might be required should be contacted and arranged in advance to familiarize them with the project.

Site management must ensure that:

- Everyone on site is aware of the rescue plan
- Equipment and other resources are available
- Designated personnel are properly trained.

Residential roof work on existing buildings

Part 31, Division 2 of the workplace safety and health regulation applies to residential construction where roofing material is repaired, applied to or removed from an **existing building**, provided that:

- (a) the eave height is not more than 6 m (20 ft); and
- (b) the fall height is more that 3 m (10 ft).

Nothing in Division 2 limits or restricts the application of Division 1 to residential construction projects.

Note: Part 31, Roof Work applies to existing building only and not to new construction. New construction regulatory requirements fall under Part 14.

Roof Slope Requirements: existing structures only

Requirements re: slopes 4:12 to 6:12

When, an existing residential building roof deck has a slope greater than 4:12 but not greater than 6:12, an employer must ensure that

- (a) roof jacks and toe-boards are installed
 - (i) continuously along the length of the eave, and
 - (ii) below the work area at intervals of not more than 2.4 m as measured along the roof deck;
- (b) guardrails are installed; or

(c) a fall protection system as required under Part 14 (Fall Protection) is provided.

If the eave height is greater than 6m (20 ft), fall protection systems are required under Part 14 (Fall Protection).

An employer must ensure that a roof jack is provided with an effective non-slip device and has a toe-board of at least 50 mm x 150 mm (2 x 6 in) (nominal) securely fastened to it.

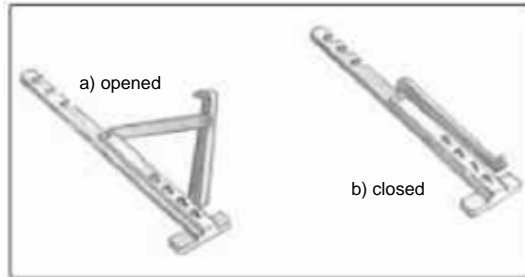

Folding roof jacks

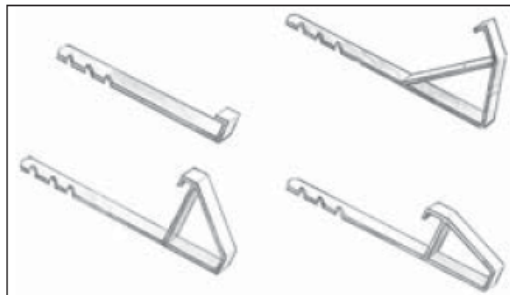

These are examples of various kinds of roof jacks.

Requirements re: slopes more than 6:12 - existing structures

When, an existing residential building roof deck has a slope greater than 6:12, an employer must ensure that guardrails are installed. If the installation of guardrails is not practicable, a fall arrest system as required under Part 14 (Fall Protection) must be provided.

When a roof slope varies at different locations along a roof deck, the requirements above mentioned apply to each location individually.

Note: Part 14 (Fall Protection) does not apply to a residential construction project where the slope of the roof deck is 4:12 or less.

Example sloped roof fall protection system.

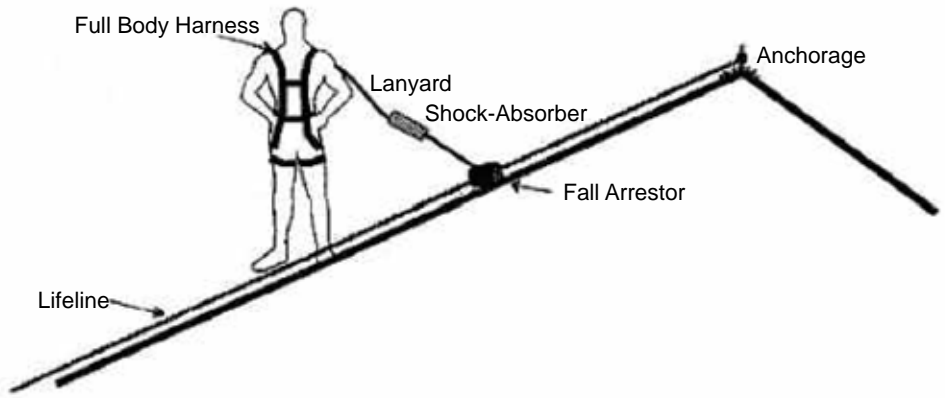

DEFINITIONS

Anchorage – a permanent structure or part of a structure designed to withstand any fall arrest forces imposed on it.

Anchorage Connector – a component or subsystem that attaches either permanently or temporarily to an anchorage, and that provides flexible and functional connection to the rest of the PFAS systems and subsystems when anchorage by itself would not.

Automatic descent control device – a device that, once engaged, lowers the user at a constant speed. The user has no ability to stop or control the rate of descent.

Body Belt - a body support device that encircles the body at or about the waist.

Body-holding device – a device intended to support the weight of an individual in the event of a fall. It is also designed to prevent or minimize injury to the individual resulting from the forces placed on the body during arrest of the fall and subsequent suspension. Body-holding devices may also be designed to support an individual's body weight during the use of a descent control or work-positioning device, or to function as part of a work restraint system.

Connector - a component or element that is used to couple parts of a system together.

Connecting Components (connectors) -

Carabiner – a Class I connecting component that generally consists of a trapezoidal or oval body having a self-locking feature that may be opened to permit the body to receive an object and that, when released, automatically closes and locks to prevent inadvertent opening.

D-Ring – a connector used integrally in a harness as an attachment element or fall arrest attachment, and in lanyards, energy absorbers, lifelines, and anchorage connectors as an integral connector.

O- Ring – a circular connector

Oval-Ring – an oval connector

Self-locking connector – a locking type connector with a self-closing, self-locking mechanism that remains closed and locked until intentionally unlocked and opened for connection or disconnection

Snap hook – a Class I connecting component that consists of a hooked-shape body having a self-locking and self-closing feature that may be opened to permit the body to receive an object and that, when released, automatically closes and locks to prevent inadvertent opening. Snap hook connectors also have an integral closed eye, either fixed or swivelling, to be permanently fastened to a subsystem.

Descent control device—a device that is designed and intended to be used and operated by one person for personal descent or to lower another person from an elevation. A descent control device may be used either for egress or for work positioning, or both.

Emergency egress—an evacuation from a location in the event of emergency. From an elevated location, emergency egress may require controlled descent.

Emergency egress body-holding device—a body-holding device that is manufactured for integral connection to a Type 1E or Type 2E descent control device.

Energy absorber—a component or element that is included as an integral part of an SRD that dissipates kinetic energy and limits deceleration forces during a fall.

Full body safety harness—a device, meeting the requirements of CSA Standard Z259.10, that is made primarily out of straps for containment of the torso and pelvic area (and optionally the waist area), and that is designed to support the user during and after the arrest of an accidental fall and/or during a rescue operation and/or during work activities, depending on the group classification of the harness.

Fall Arrest System (FAS) - a series of components that, when used properly together, will come into service and arrest a worker's fall.

Fall Restricting Equipment (FRE) - a component of a fall restrict system (e.g. modified pole strap, rigid but articulated frame, or other such devices) that, when combined with other sub-components and elements, allows the climber of a pole to remain at his or her work position with both hands free and that performs a limited fall arrest function when contact is lost between the climber's spurs and the pole.

Fall Restrict System (FRS) - a combination of a work positioning system (WPS) and FRE. Hardware—connecting components constructed of solid rigid materials such as metals or other types of composite materials, as opposed to connecting components manufactured by such means as stitching, rope splicing, swaging, and heat fusion. See CSA-Z259.14 Fall Restrict System for Wood Pole Climbing for further information.

Integral - not removable from any component, subsystem, or system without mutilating any of its elements or using a special tool.

Lifeline—a flexible line or rope made of synthetic fibre, wire or webbing that is attached to an anchor point at one end and along which a fall arrestor travels.

Manual descent control device—a descent control device that gives the user control over the rate of descent and the ability to stop the descent. Manual descent control devices are subdivided into two further categories: those which have automatic lockoff features and those which do not.

Saddle - a device between the knees and buttocks that, with an integral belt, supports the body and is used for work positioning or suspension.

Self-retracting device (SRD) –a device that performs a tethering function while allowing vertical movement (below the device) to the maximum working length of the device, which will arrest a user's fall. An (SRD) has housing, normally attached to the anchorage of FAS that contains a drum-wound lifeline. The retraction end of the lifeline will unwind from the drum under slight tension during the normal movement of the user below the device. When tension is removed, the drum will automatically retract the lifeline. Quick movement such as is typically applied in a fall will lock the drum, arresting the user's motion. The SRD is designed to arrest a fall while minimizing fall distance and impact force.

Self-retracting lanyard – Type 1 (SRL) –an SRD which is short in length e.g. 1.5m (5 ft) to 3.0 m (10 ft) working length. It is compact and lightweight, allowing attachment of the housing to the body support. The SRL's internal locking mechanism is not capable of absorbing significant amounts of energy. Like a standard lanyard, an SRL subjected to the force of a fall must be retired from service.

Self-retracting lanyard – Type 2 (SRL) –an SRD which is generally long in length (greater than 3.0 m (10 ft) working length). The larger SRL is typically too heavy to attach to the body support. It has an internal shock-absorbing mechanism that works with the brake to minimize impact forces. The SRL must have a visible load indicator. It is repairable after a fall incident and is subject to a manufacturer's service schedule.

Self-retracting lanyard with retrieval capability – Type 3 (RSRL) –an SRD which will perform a fall-arrest function as a Type 2 device. When a user becomes incapacitated as a result of a fall or other incident, a Type 3 device will allow a single attendant to raise or lower the casualty to a safe level. Type 3 devices must meet all the criteria for Type 2 devices as well as Type 3.

Single attachment point (dynamic attachment component) – a Class I connecting component that is an integral part of a PFAS system or subsystem, and that is designed to connect related subsystems together and/or to connect the system to an anchorage or an anchorage connector.

Single attachment point – a Class II connecting component used for work positioning, descent, rescue, and other such purposes not involving fall arrest.

Travel Restraint System (TRS) - an assembly of components that, when properly assembled and used together and when connected to a suitable anchorage, prevents a worker from approaching and reaching an unprotected edge or opening where a fall could occur. A TRS is not intended for use as a work positioning system or FAS. A full body safety harness connected to a suitable lanyard and anchorage is an example of a travel restraint system.

Work Positioning System (WPS) - an assembly of components that, when properly assembled and used together, supports a worker in a position or location so that the worker's hands are free in the work position. A WPS is not intended for use as FAS. Note: A lineman's body belt or harness, or both, in addition to a pole strap and spurs, constitute a work positioning system for climbing and working on a pole.

Visual load indicator – a component of an SRL that allows the field operator to determine when the device has arrested a fall.

Working length – the effective extended length of an SRD from the load-bearing point on the housing (Type 2 (SRL) or housing connector (Type 1 (SRL), to the load-bearing point on the bottom connector.

Work positioning – supporting a user in a position or location in which he can do his work, (ex a worker on a utility pole).



Lockout and Tag Out Policy/Program

1. Purpose

The City of Winnipeg – Water and Waste Department is committed to protecting its employees, contractors and the public from injury and ill health, as well as protecting the work and natural environment from damage caused by inadvertent start-up of machinery, equipment or processes. This policy establishes a process for isolating hazardous energy and preventing the release, start-up, or transmission of machine, equipment or process energy.

2. Objectives

The objectives of this policy are to:

- a) protect personnel from injury due to the release, start-up, or transmission of machine, equipment or process energy
- b) establish methods for achieving zero energy state
- c) comply with the requirements of the Workplace safety and Health Act and applicable regulations.

3. Scope

A) Application

This policy applies to all employees and contractors involved in

- a) activities such as erecting, installing, constructing, repairing, adjusting, inspecting, cleaning, operating, and maintaining machines, equipment, and processes, and
- b) energy sources such as electrical, mechanical, hydraulic, pneumatic, water pressure, chemical, radiation, thermal and compressed air, as well as stored energy in springs, suspended parts, electrical components, or any other device.

B) Installation design requirement

Energy-isolating devices must be designed to accept a lockout device that will secure them in the isolated position whenever

- a) machines or equipment are replaced, repaired, renovated or modified,
- b) a process is performed, or
- c) new machines, equipment, or processes are installed.

4. Definitions

Affected employee – a person who operates a machine, a piece of equipment, or a process on which servicing or maintenance is being performed under lockout.

Authorized employee – a person assessed competent to apply the lockout/tag out process and to lock out and tag out machines, equipment, or processes in order to service or perform maintenance on the machines, equipment, or processes.

Capable of being locked out (with respect to an energy-isolating device) – an energy-isolating device designed so that a lock can be affixed or built into it. Other energy-isolating devices are also considered capable of being locked out if lockout can be achieved without the need to dismantle, rebuild, or replace the energy-isolating device or permanently alter its energy control capability.

De-energize – to disconnect and isolate a machine, process or equipment, and further eliminate any residual or stored energy due to pressure, temperature, chemical substances, motion, gases and electricity, in order to attain a zero energy state that can be confirmed by testing.

Energy-isolating device – a mechanical device that physically prevents the transmission or release of energy, including:

- a manually operated electrical circuit breaker
- a disconnect switch
- a manually operated switch by which the conductors of a circuit can be disconnected from all ungrounded supply conductors and no pole can be operated independently
- a line valve
- a block
- a blank
- any similar device used to block or isolate energy

This term does not include push button, selector switch, and other control-circuit-type devices.

Hazardous energy – any electrical, mechanical, hydraulic, pneumatic, chemical, nuclear, thermal, gravitational or other energy, which can harm personnel.

Lockout – placement of a lockout device on an energy-isolating device to ensure that the energy-isolating device and the equipment being controlled cannot be operated until the lockout device is removed.

Lockout device – a keyed lock that secures an energy-isolating device in a position that prevents the re-energizing of a machine, piece of equipment, or process. Also includes devices such as hasps, valve covers, circuit breaker lockouts, ball valve lockouts, electrical plug lockouts, group lockout boxes.

LOTO – means lockout/tag out, and will be referred to throughout the document.

Operational Caution tag – a lime green tag used to warn of a potential hazard or to warn that the device is to be left on.

Other employee – a person whose job requires him or her to work in an area where machine, equipment, or process servicing or maintenance is being performed.

Primary authorized employee — a person assigned as the lead authorized employee under the group lockout process to apply and coordinate removal of the lockout of a machine, piece of equipment, or process on which work will be performed.

Principal authorized employee — a person assigned responsibility for a crew or work group under the group lockout process when more than one work group is involved.

Red tag – a warning tag used to warn employees of an existing or potential hazard. In addition to the warning, its wording also identifies who applied the tag (for details see section 5c Red Tag procedure).

Servicing/maintenance – workplace activities such as constructing, installing, setting up, adjusting, inspecting, modifying, maintaining, and servicing machines, equipment, or processes. These activities include:

- lubrication
- cleaning
- repairing or unjamming of machines or equipment
- making adjustments to tool changes where the employee could be exposed to the unexpected energization or start-up of a machine or piece of equipment, or to the release of hazardous energy

Tag out – the placement of tags, signs, placards and other warning devices such as barricades, attendants, and automated warning systems that will warn personnel of potentially hazardous conditions where the lockout of energy isolating devices is not possible.

Testing – verifying the isolation and de-energization of machines, equipment or processes by using the controls or special testing equipment to confirm a zero energy state.

5. Procedure

A) Lockout/Tag Out System

1. Identification

Each division manager must carry out a documented hazard assessment to identify all hazardous energy systems that must be isolated, locked out, or tagged out to control hazardous energy when service or maintenance of machinery, equipment or processes takes place. This assessment must be carried out before developing documented energy isolation, de-energization, or lockout or tag out procedures.

2. Application and exposure survey

In addition to carrying out the hazard assessment, each division must conduct an application survey to determine whether the machine, equipment, or process can be safely isolated. When isolation of a hazardous energy system or a portion of it is required, an authorized employee must consult the appropriate operating drawing (where applicable) and identify the isolation device(s) and any other equipment needed to attain a zero energy state, and

- a) determine whether energy-isolating devices are available, adequate, and practically located for positive protection,
- b) clearly mark the energy-isolating devices to be used and write procedures for using these devices whenever tasks are performed that require the de-energization of the machine, equipment, or process, and
- c) develop a plan to correct the surveyed deficiencies (if any) or provide interim alternative protection (tag out) to make the energy isolation system effective until the deficiencies have been corrected.

Each division must conduct an exposure survey to determine which tasks are being performed while the equipment or process is energized (e.g., greasing chains and oiling machines). Each situation must be evaluated to determine whether the task can be accomplished with the power off or, alternatively, which method needs to be used to reduce employee risk.

3. Documented Procedures

Each division/facility must develop specific energy-isolation procedures for machines, equipment, processes, components, utilities, etc. The procedures must include all lockout and tag out locations and methods for each energy system and the sequence or steps required to attain a zero energy state. Procedures must be developed for each circumstance where isolation and de-energization to a zero energy state is required for servicing and maintenance.

A “Lockout checklist for energy isolation” must be developed when 3 or more energy isolation devices are used on a machine, piece of equipment or process.

When developing specific procedures to bring each piece of machinery, equipment or process to a zero energy state, each division/facility must answer and address the following questions (see Appendix 2 for sample form to use):

- Does the equipment have isolated or centralized control?

- What are the energy sources present for the equipment?
- What are the methods to isolate each energy source (e.g., define the breaker number and electrical enclosure number for all electrical equipment, valve number, blanks and blocking and their location, etc.)?
- What is the method to test the equipment to ensure the equipment does not activate during the lockout and ensure there is no residual or stored energy?

For centralized controlled equipment these additional questions should be answered:

- Who needs to be informed of the lockout and startup of the equipment?
- Who turns off the equipment before de-energizing/controlling it?
- What will prevent the central control personnel from unintentionally trying to start the de-energized equipment?
- How will the equipment be tested at the centralized control to make sure it will not start (if possible)?

Note: These lockout procedures must be posted or otherwise readily available for the authorized personnel to review and use.

4. Principles for LOTO

- a) All personnel (hourly and salary) must comply with the provisions of the lockout policy and program. All levels of supervision must enforce the LOTO program and the use of personal locks and tags where required, in order to protect all personnel required to perform tasks where exposure to unexpected energization may occur. They must immediately suspend the work if the provisions of the program are not in place or are not being followed.
- b) Only standard keyed locks and red tags may be used to lockout energy isolating devices on equipment and/or process. Locks and tags as part of the lockout system must not be used for any purpose other than personal protection.
- c) Individual locks and tags must be applied and removed by each person exposed to the potential of unexpected energy release, other than in special situations where procedures have been developed and approved to control hazardous energy sources.
- d) Where equipment is lockable, all exposed personnel must apply their own lock.
- e) Where equipment is not lockable, a tag must be applied in a conspicuous location and all exposed personnel must follow the special hazardous energy control procedures that are documented and approved.
- f) Locks used in the lockout application must be accompanied by red tags and employee identification tags.
- g) Energy-isolating devices must be clearly labeled or identified to indicate their function. This identification is necessary to reduce possible errors in applying the lockout.
- h) All isolation points on equipment must be labelled with unique identifying names and entered on the one-line diagrams.
- i) Lockout procedure(s) must be developed where hazardous energy must be controlled, clearly defining controlling authority of plant and auxiliary equipment, and requiring the development and checking of switching plans, if used.
- j) The lockout of electrical energy sources must have a visible open point that occurs at the circuit disconnect switch.

- k) Electrical control circuitry must not be used to accomplish lockout because it does not offer positive personnel protection. Examples of conditions that can by-pass electric control circuitry include
 - (i) electrical shorts (water in lines and some types of dust can create a path to complete the control circuit)
 - (ii) vibration or switch component failure
 - (iii) remote or interlocked switches not affected by control circuitry

5. Protective appliances, lockout devices and warning tags

- a) **Personal locks** – Locks must be purchased specifically for lockout applications. They must be of such design and quality that they cannot be easily removed. In addition, each individual must use individually keyed locks for personal protection. The following is a list of colours and the trades assigned to each colour on the locks. It must be possible to mark the employee’s name on the lock. Supervisors must maintain a specific list of lock numbers for their work area.

| <u>Color</u> | <u>Area</u> |
|----------------|--------------------------------|
| Orange | Supervisors |
| Green | Mechanical |
| Red | Electrical/Instrumentation |
| Yellow | Civil Maintenance |
| Purple | Computer Process |
| Clear (E2. 10) | Collections |
| Blue | Operators- Water Services |
| Black | Operators- Wastewater Services |

- b) **Common Locks** – The following areas have common locks where the entire trade area has a copy of the key. Common locks must only be used to secure equipment in the “off” position when not being worked on.

| <u>Lock Type</u> | <u>Area</u> |
|------------------|--------------------------------|
| CISA | Mechanical |
| CISA | Electrical/Instrumentation |
| PAPAIZ | Operator- Water Services |
| MASTER | Operators- Wastewater Services |

- c) **Red Tag Procedure** – a red “*DO NOT START or USE*” tag must be attached to lockout points on energy-isolating devices to indicate the potential for a dangerous situation to occur. The tag must prohibit the startup, activation or use of the equipment. Red tags can be removed only by authorized repair personnel. Tags must not be reused and must be kept by the supervisor for 1 year minimum after use.

- d) **Tag Out Tag** – This is a tag placed on machinery, equipment or a process that does not have a lockable energy-isolating device and where hazardous energy conditions exist that have been effectively isolated and a zero energy state attained.

e) Hasps – Where more than one lock is to be applied to an energy isolating device, a hasp must be applied first to accommodate multiple locks to secure an energy-isolating device.

Note: *Some exposures can require additional protective techniques or mechanical safeguards.*

f) Valve lockout – Where possible, line valve and ball and butterfly valves must be secured using proper lockout covers/devices.

5. Responsibilities

General

- a) Management is responsible for developing, implementing, and administering the lockout program.
- b) All employees must comply with the provisions of the lockout program.
- c) Affected employees must be aware of lockout procedures used to guard against unexpected start-ups, and must be made aware when a lockout condition will affect them.
- d) Only authorized employees may operate energy-isolating devices and place locks and tags on controls to prevent unexpected start-ups.
- e) Other employees who work in the area where lockout procedures are used must be instructed by facility supervisor about their purpose and prohibited from attempting to restart or remove LOTO from machines, pieces of equipment, or processes that are locked and/or tagged out.

Specific

- f) Division managers are responsible for ensuring the LOTO program is in place and followed at their facility or operations. This includes
 - developing procedures that employees must follow when controlling hazardous energy by de-energizing, locking out, or tagging out (or using other suitable means) the machinery, equipment or process
 - immediately stopping any work where LOTO is not in place
 - ensuring energy-isolating devices are properly identified and entered on the one-line drawings
 - arranging for employees to take LOTO training and instruction
 - investigating all cases of non-compliance with LOTO to determine the cause of non-compliance and putting in place measures so that they will not be repeated
- g) Supervisors/foremen/shift operators/lead hands are responsible for
 - assigning LOTO work only to authorized employees
 - ensuring employees follow LOTO procedures and the LOTO program
 - stopping immediately any work where LOTO is not in place and reporting these situations to the division manager
 - informing affected employees when LOTO will affect them and their work
 - informing authorized employees when the machinery, equipment or process is ready for them to start the LOTO work
 - ensuring there are enough locks and tags available at all times
- h) Authorized employees are responsible for
 - following and implementing LOTO according to the LOTO program and documented procedures

- informing their supervisor immediately if the lock out is not effective
- i) Affected and other employees are responsible for
- following the procedures and requirements of the LOTO program
 - preparing machinery, equipment or process for LOTO by authorized employees
 - **under no circumstances** attempting to re-start any machinery, equipment or process that is locked out or tagged out, or attempting to remove the lockout/tag out on any machinery, equipment or process

B) System use

1. Preparations for lockout or tag out

- a) The employee's supervisor or authorized employee must notify all personnel affected by the intended lockout/tag out before starting any LOTO work.
- b) Before starting the LOTO work, the affected employee's supervisor or designate must verbally inform the authorized employee(s) that they are permitted to access the machine, equipment, or process and start their LOTO work.
- c) When the complexity of the machine, equipment, or process, or where the nature and scope of the work, warrants it, a pre-job work plan and check list must be developed by the affected employee's supervisor or designate. The plan must
- identify all machines, equipment, or processes included in the particular complex work
 - list all types of hazardous energy
 - explain the isolation and controls necessary for the job, including the type, number, and location of the energy-isolating devices
 - state the job objectives and estimated job duration
 - list the workers involved
 - explain the shut down and start-up provisions, and any other conditions required to make the work safe
- d) The authorized employee must notify the controlling authority and document on a lockout/tag out form the section being isolated, the isolation devices, and the tag and/or lock numbers that will be applied. When 3 or more isolation devices are required, the document should be checked and signed by a second authorized person.

2. Application of lockout

Authorized employee(s) must lock out energy isolation devices any time when

- the machinery, equipment or process has a guard removed or a safety device rendered inoperable,
- there could be contact with moving parts, energized circuits, or mechanical energy, or
- the release of stored energy or a pressurized system, or the discharge of a gas or liquid.

Authorized employees must:

- a) follow appropriate machine, equipment, and process shutdown procedures to deactivate operating controls or return them to the neutral mode,
- b) follow appropriate machine, equipment, or process energy-isolating procedures to operate or position the energy-isolating devices in a manner that isolates the machine, equipment, or process from the energy source(s),
- c) attach lockout devices in such a manner as to positively position the energy-isolating device(s) in the isolated position; and complete the tags and attach them to the energy-isolating device(s), and
- d) carry out one or more of the following actions to verify that that the machine, equipment, or process has been de-energized and cannot be restarted:
 - (i) Operate the machine, equipment, or process controls (push buttons, switches, etc.) to prove that energy isolation has been accomplished. Deactivate the controls or return them to the neutral mode after test.
 - (ii) Check the machine, equipment, or process with test instruments or visual inspection to prove that energy isolation has been accomplished.
 - (iii) Check the machine, equipment, or process for any residual energy by opening bleed valves or by implementing other appropriate checks. If residual energy is detected or suspected, take action to relieve or prevent re-energization.

Note: *This can require the installation of temporary grounds and/or mechanical blocks.*

3. Application of Tag Out - When the machinery, equipment or process does not have a lockable energy-isolating device, these general procedures must be followed:

- a. Follow appropriate machine, equipment, and process shutdown procedures to deactivate operating controls or return them to the neutral mode (if the equipment has an on/off control – place in “off” position).
- b. Isolate the machine, equipment, or process from the energy source(s) by blocking, blanks, balloons or other appropriate methods.
- c. Barricade access to areas where energy isolating devices have been installed
- d. Complete and attach red tags to the controls and the energy-isolating device(s) and provide the completed lower portion of the tag to the supervisor.
- e. Verify that that the machine, equipment, or process has been de-energized and cannot be restarted or activated by:
 - i. checking the machine, equipment, or process with test instruments or by visual, auditory or tactile inspection to prove that energy isolation has been accomplished
 - ii. checking the machine, equipment, or process for any residual energy by opening bleed valves or by implementing other appropriate checks. If residual energy is detected or suspected, take action to relieve or prevent re-energization. Note: This can require the installation of temporary grounds and/or mechanical blocks

4. Release from lockout or tag out

Authorized employee(s) must release the lockout as follows:

- a) Remove each lock and tag before leaving the job – the individual who applied the lock(s) or tag out must remove it. Remove locks in the reverse order of installation or by following the special instructions in the procedures.

- b) Notify the individual responsible for the machine, equipment, or process (the affected employee) when the work is complete and the overall lockout/tag out has been cleared.
- c) Before re-energizing the machine, equipment, or process, visually inspect the work area to check that all personnel are clear of the work site, all non-essential items have been removed, and all components are operationally intact and guards in place.
- d) Return used tag(s) to supervisor/foreman.

5. Emergency removal of locks or tag out condition - lockout and tag out removal when authorized employee is absent

- a) The emergency removal of a lock or tag out may only take place if the individual who installed the lock or tag out can not be located or contacted even after a thorough search on and off the work site.
- b) Only the employee's supervisor along with the foreman/lead hand is authorized to remove the lock(s) or tag out belonging to another employee, and there must be a worker from that trade present to assist in determining the condition of the machine/process/system to ensure the safe removal of the lock out or tag out.
- c) The procedure for the removal of a lock(s) or tag out must follow these steps:
 - 1) The supervisor along with the foreman/lead hand is responsible for removing the lock(s) and can not delegate this to another employee.
 - 2) The supervisor, the foreman/lead hand and worker must all agree on the action to remove the lock(s) and all must be present during the removal.
 - 3) The supervisor along with the foreman/lead hand must make every reasonable effort to contact the employee who installed the lock(s) or tag out before starting the removal procedure.
 - 4) The supervisor along with the foreman/lead hand, with the assistance of the worker from the trade must make sure, and all must agree, that the machine, process or system is safe to operate before the lock(s) or tag out is removed.
 - 5) The foreman/lead hand must inform the employee at the start of the employee's next shift that the lock or tag out was removed and give him or her a copy of the form "Notice to Employee of Lock Removal". (See appendix 1 notice of lock removal form)
 - 6) A *Record of the Emergency Removal of a Lock(s)* form must be completed and the original kept on file with the Supervisor for the work area, and copies sent to the division manager, department safety officer and the safety and health committee.

6. LOTO logs

Logs must be maintained at each facility to record the status of facility systems and use of one-line diagrams. All LOTO operations must be recorded when a lock and tag are to remain in place for more than one shift. This record keeping may be accomplished by using the attached log book (appendix 3).

C) Special lockout situations

1. Lockout interruption (energized testing)

In situations where energy-isolating devices are locked out and it is necessary to test or position the machine, equipment or process, the following sequence must be followed:

- a) Ensure that the machine, equipment, or process components are operationally intact.
- b) Remove any temporary de-energization devices.
- c) Clear the machine, equipment, equipment, or process of tools and materials.
- d) Clear personnel.
- e) Clear the energy-isolating device(s) of locks and tags (in accordance with established procedures).
- f) Proceed with test.
- g) De-energize, relock, and tag energy-isolating device(s).
- h) Operate controls, etc., to verify energy isolation.
- i) Reapply any temporary de-energizing devices.
- j) Allow work to restart.

Exception

Unique requirements for machine, equipment, or process service (e.g., testing equipment) can necessitate employee activity under energized conditions. Facilities must evaluate each of these tasks to provide safeguarding techniques that are documented to protect employees from machine, equipment, or process exposures.

2. Exposure of non-Water and Waste Department personnel

Department personnel must inform the outside service provider or contractor designated representative of any special or unique hazards that are related to the machinery, equipment, or processes.

Department personnel and outside employers (contractors, etc.) must inform each other of their lockout procedures. Each division or facility must ensure that its employees understand and comply with the requirements of the outside employer's or mutually agreed-upon energy control procedures.

3. Multiple personnel protection (group lockout)

For major machine, equipment, or process overhauls, rebuilds, etc., that require crew, craft, branch, or other group lockout, facilities must develop a system that gives employees a level of protection equivalent to that provided by personal lockout. These provisions must be documented and reviewed by all authorized and affected employees before the work starts.

4. High-voltage work

Facilities must write procedures to describe the lockout measures necessary when employees are required to work on isolated high-voltage circuits or equipment (above 600 V). **Note:** All equipment operating at voltages greater than 600 volts requires a certified electrician to turn off the circuit breaker/switch that supplies power to the equipment.

5. Shift change.

To maintain continuity of protection for those involved in a LOTO procedure, and to ensure the orderly transfer of LOTO devices, the following procedures must be followed when personnel or shifts change.

- a.) When personnel change, the arriving LOTO-authorized worker's lock and tag must be applied before the departing LOTO-authorized worker's lock and tag is removed.

- b) When shifts change, the lock and tag of at least one LOTO-authorized worker on the arriving shift must be applied before any locks and tags of the departing shift are removed. The departing crew must inform the arriving crew of the status of equipment and work in progress.

Note: This element applies only if work from the first shift will be carried on by the second shift.

D) Education and training

Divisions must provide education and training as follows:

- a) Employees must be trained before assignment to ensure that they understand the purpose and function of the division lockout program and acquire the knowledge and skills required for the safe application, use, and removal of energy controls. The training must include the following essential elements:
 - (i) instructing each affected employee in the purpose and use of the energy control procedure
 - (ii) training each authorized employee in the recognition of applicable hazardous energy sources, the type and magnitude of the energy available in the workplace, the methods and means necessary for energy isolation and control, and the means of verification of control
 - (iii) instructing other employees whose work operations are or could be in an area where energy control procedures could be used about the procedures and about the prohibition against trying to restart or re-energize machines or equipment that are locked out or tagged out
- b) Employees must be retrained every 3 years to confirm or re-establish employee proficiency with control methods and procedures, as well as the following provisions:
 - (i) retraining all affected and authorized employees whenever there is a change in job assignments, a change in machines, equipment, or processes that presents a new hazard, a change in the energy control procedures, or a revision of control methods
 - (ii) conducting additional retraining whenever periodic audits (see below) reveal or supervisory work observations give reason to believe that correct practice is not being followed or an employee's knowledge or use of energy control procedures is inadequate.
- c) Division documentation must certify that employee training has been accomplished and is being kept up-to-date. The certification must record each employee's name, People Soft number, and dates of training.

Periodic Inspections

- a) The foreman/lead hand must inspect LOTO procedures at least annually.
- b) If the foreman/lead hand is not trained as a LOTO authorized worker, he or she must designate a LOTO authorized worker (other than the workers being inspected) to conduct the inspection.
- c) The foreman/lead hand must accompany the LOTO authorized worker during the inspection. This inspection shall include observing how well LOTO-authorized workers follow LOTO procedures and comply with the Water and Waste Department LOTO Program.

- d)** The foreman/lead hand must certify completion of the inspection by entering the name of the equipment, the date of inspection, and the names of the workers involved in the inspection (including the person who performed the inspection) on the LOTO Inspection Form (see Appendix 4).
- e)** Any discrepancies identified during inspection must be documented on the LOTO Inspection Form and shall be corrected before that LOTO-authorized worker can perform further lockouts.
- f)** The original inspection form must be kept on file with the Supervisor, and copies sent to the division manager, department Safety Officer and the safety and health committee.

For details on developing division or facility individual lockout procedure(s), see the Canadian Standards Association Control of Hazardous Energy – Lockout and Other Methods Z460-05 or contact the Water and Waste Department Safety Officer at 986-8299.

APPENDIX 1



NOTICE TO EMPLOYEE

Name: _____

Lockout device and information tag removed

Section

Lockout Policy

Please report to your immediate Supervisor

Date: _____

Supervisor: _____

LOTO Procedure for Specific Equipment Form

APPENDIX 2

Use a copy of this form to identify all isolation/lockout points for existing and new equipment. Use this information to create LOTO procedures. Post this lockout procedure or have it readily available for the authorized individuals to review and use.

| | | | |
|---|---------------------------------------|---|--|
| Date: | Person Completing Form (print) | | |
| Equipment Name | | Tag ID: | |
| Equipment Location: | | | |
| Is the equipment centrally or remotely controlled? (Circle) | | Yes | No |
| If yes, then be sure to identify all points at MCC or similar system and the following information: | | | |
| Who is to be informed? | Who turns off the equipment? | Is person required also to lock out equipment? | Control in place to prevent startup |
| | | | |
| | | | |
| Describe how to turn off equipment: | | | |
| | | | |
| Use the following codes to identify the energy source: NP – Non Potable Water; PW – Potable Water; EL – Electrical, HW – Hot Water; PN – Pneumatic; HD – Hydraulic; HC – Hazardous Chemical; BH – Bio-Hazardous; | | | |
| Energy Source | Isolation Point | Panel | Location of Control Point |
| | | | |
| | | | |
| | | | |
| | | | |
| | | | |
| | | | |
| Describe how to remove or prevent residual energy from occurring: | | | |
| | | | |
| Describe test to confirm equipment will not start: | | | |
| | | | |
| Signature of Authorized Employee: _____ | | | |



**APPENDIX 3
LOCKOUT AND TAG LOG**

BUILDING _____

| NAME AND LOCATION OF EQUIPMENT LOCKED OUT AND TAGGED | ID FOR LOCKOUT DEVICE | DATE INSTALLED | AUTHORIZED EMPLOYEE'S NAME | DATE REMOVED |
|---|--------------------------------------|---------------------------|---|---------------------|
| | | | | |
| | | | | |
| | | | | |
| | | | | |
| | | | | |
| | | | | |
| | | | | |
| | | | | |
| | | | | |
| | | | | |
| | | | | |
| | | | | |
| | | | | |
| | | | | |



APPENDIX 4

LOTO Inspection Checklist and LOTO Inspection Form

Work supervisors must ensure by onsite observation that LOTO-authorized workers follow the requirements of the Water and Waste Department LOTO Program. Use the checklist below, and then complete the LOTO Inspection Form in this appendix.

LOTO INSPECTION CHECKLIST

Knowledge of LOTO-Authorized Workers

- Can the LOTO-authorized worker demonstrate knowledge about:
 - The Water and Waste LOTO Program?
 - The appropriate lockout and tag out devices?
 - The location of all energy-isolating devices?
 - All secondary or residual energies (if applicable)?
 - The energy-isolation verification procedures?
 - The procedures necessary for equipment that does not have a lockable energy-isolating device (if applicable)?
 - The log-keeping requirements?

Training

- Has the LOTO-authorized worker received the required training in the past three years?

Lockout and Tag out Devices

- Are there enough locks and tags?
- Is the standard WATER AND WASTE DEPARTMENT LOTO lock being used?
- Is the correct version of the WATER AND WASTE DEPARTMENT LOTO tag being used?
- Is a LOTO log available (if required) and up to date?

Equipment

- Are energy-isolating devices properly labelled?
- Are energy-isolating devices lockable?

- Are energy-isolating devices (other than electrical devices) required for LOTO (e.g., valves)?
- Are valves adequately identified, and are suitable locking devices available?
- Are other devices (e.g., blank flanges, blocks, or chains) required for LOTO, and are these devices available?
- Are copies of the applicable energy control procedures available?

LOTO INSPECTION FORM

This form must be completed by the work supervisor (or designated LOTO-authorized worker) who inspected the LOTO-authorized worker's use of LOTO procedures. The work supervisor confirms performance of the inspection by signing this form.

Date: _____

1. List the equipment/machines on which the LOTO procedure is being used.

2. Provide the names of the LOTO-authorized workers who performed the LOTO procedure that was inspected.

3. Identify any discrepancies uncovered by completing the LOTO Inspection Checklist. List any corrective actions.

Signature of Inspector

Date



Winnipeg

Water and Waste Department

Environmental Management Policy

We have an Environmental Management System (EMS) to help us manage our environmental impacts and risks, and improve our environmental performance.

As part of this program, we must all take responsibility for minimizing the effects of our work activities on the environment.

The Environmental Management System also requires that we record all operational and EMS non-conformances on the appropriate forms.

The Water and Waste Department's sewage treatment facilities, and wastewater collection and land drainage systems, aim to achieve excellence in environmental services, pollution prevention, and protection of public health through a commitment to continually improving the Environmental Management System.

We are committed to:

1. Understanding and respecting the views of our customers, employees, communities and stakeholders when planning and undertaking our activities.
2. Remaining current with advancing and innovative technology and management practices in our facilities.
3. Ensuring awareness, training and involvement of all staff to enable them to conduct their work in an environmentally responsible manner and to play a full role in continual improvement.
4. Aiming for best performance and sustainability in all aspects of our business to ensure compliance, at the highest level, with legislative requirements and our own standards.
5. Reviewing our environmental objectives and targets annually to ensure improvement in our environmental performance.



Director, Water and Waste Department

ENVIRONMENTAL PRESERVATION AND COMPLIANCE

Working on behalf of Wastewater Services, your performance during all contracted obligations is critical to our commitment to protect the environment and comply with all environmental legislation. Please read our attached Environmental Policy.

Without limiting or otherwise affecting the generality or application of any other term or condition of the Contract, you shall, at no additional cost to the Wastewater Services Division:

- a) strictly comply with all applicable environmental laws and regulations and have suitable corrective and/or preventive measures in place to address any previous environmental warnings, fines or convictions;
- b) do or cause to be done all things required or ordered, and shall bear all costs and expenses for same, to mitigate environmental damage caused, directly or indirectly, by itself or by its servants, agents, employees or subcontractors, accidentally or as a result of practices that are or may be in contravention of the Contract or any environmental laws or regulations, or to prevent any or all of the same;
- c) ensure that all persons engaged in the performance of the Work and the Contract shall not dispose of oil or waste materials in any way which might cause pollution of land, water, lakes, rivers, streams;
- d) ensure that all persons engaged in the performance of the Work and the Contract shall follow any Safe Work Procedures provided by the contract administrator;
- e) ensure the Work, and all work sites are clean and free from fire hazards and other hazards, accumulations of waste materials, rubbish and debris;
- f) create as little waste as reasonably possible during the course of the Work and handle all waste created in the course of the Work in a environmentally preferable, and legal, manner;
- g) in respect of the Work, use all resources as efficiently and reasonably possible;
- h) the person who is responsible for a spill or who has custody and control of the substances involved in a spill must **immediately** notify the designated official (see contact list below), and must provide all information about the spill, including:
 - i) the date and time of the spill;
 - ii) the content and quantity of the spill;
 - iii) the location of the spill;
 - iv) the cause and nature of the spill;
 - v) the action completed and any work still in progress to mitigate the spill;
 - vi) the name and contact information of the person reporting the spill.
- i) the person who is responsible for a spill or who has custody and control of the substances involved in a spill must notify all appropriate regulatory agencies e.g. Environment Canada, Manitoba Conservation as required by law;
- j) if a spill poses an immediate danger to human health or safety, property or the environment, the person responsible for the spill or who has custody and control of the substances involved in a spill must call 911 to report the spill;
- k) the person who is responsible for a spill or who has custody and control of the substances involved in a spill must take all reasonable measures to:
 - i) contain the spill;
 - ii) reduce the risk of harm to human health and safety, property, and the environment;
 - iii) clean up the spill and contaminated residue and dispose of spill material appropriately, and
 - iv) restore the affected area to its condition before the spill.
- l) the person who is responsible for a spill or who has custody and control of the substances involved in a spill must submit a written report to the Purchaser within five working days of the spill, containing information required to determine:
 - i) information required in (h); and
 - ii) actions necessary to reduce the effect of the spill and to prevent future spills.

Contact List

| | |
|--|--------------|
| Environment Canada | 204-981-7111 |
| Wastewater Conservation | 204-945-4888 |
| Wastewater Services Division (normal work hours) | |
| Wastewater treatment plant issue: | |
| Supervisor for NEWPCC: | 204-986-4749 |
| Supervisor for SEWPCC: | 204-986-6159 |
| Supervisor for WWPCC: | 204-986-5220 |
| Collection System issue: | |
| Superintendent of Wastewater Collection | 204-986-4788 |
| Wastewater Services Division (after hours) | |
| Wastewater treatment plant issue: | 204-794-4468 |
| Collection System issue: | |
| Wastewater Services Control Centre | 204-986-7948 |

THE DANGEROUS GOODS HANDLING AND
TRANSPORTATION ACT
(C.C.S.M. c. D12)

Environmental Accident Reporting Regulation

Regulation 439/87
Registered December 8, 1987

Definitions

1 In this regulation,

"**PCB mixture**" means a mixture containing PCB in a concentration that is greater than 50 parts per million by weight; (« mélange de BPC »)

"**petroleum product**" means a refined petroleum derivative which is in a liquid state at ambient temperature and pressure, and is used or intended to be used primarily as a fuel or lubricant. (« produit pétrolier »)

Application

2(1) This regulation applies only to environmental accidents involving contaminants which

- (a) are listed in Column II of the Schedule;
- (b) have a primary or subsidiary classification set out in Column I as that classification is or can be determined under the *Classification Criteria for Products, Substances and Organisms Regulation*, Manitoba Regulation 282/87; and

LOI SUR LA MANUTENTION ET LE TRANSPORT
DES MARCHANDISES DANGEREUSES
(c. D12 de la C.P.L.M.)

**Règlement concernant les accidents relatifs à
l'environnement**

Règlement 439/87
Date d'enregistrement : le 8 décembre 1987

Définitions

1 Les définitions qui suivent s'appliquent au présent règlement.

« **mélange de BPC** » Mélange dans lequel la concentration de BPC excède 50 parties par million au poids. ("PCB mixture")

« **produit pétrolier** » Produit dérivé du pétrole par raffinage, lequel se présente sous forme liquide à la température et à la pression ambiantes et est utilisé ou sera utilisé comme carburant ou lubrifiant. ("petroleum product")

Application

2(1) Le présent règlement ne s'applique qu'aux accidents relatifs à l'environnement causés par les contaminants suivants :

- a) ceux qui sont énumérés à la colonne II de l'annexe;
- b) ceux auxquels a été attribuée une classification primaire ou subsidiaire énumérée à la colonne I des présentes conformément au *Règlement sur les critères de classification des produits, des matières et des organismes*, soit le règlement du Manitoba 282/87;

(c) are in a quantity or at a level set out in Column III of the Schedule.

2(2) This regulation does not apply to

(a) an environmental accident involving oil and salt water resulting from a break or leak in a wellhead, flow line, pipe line, tank, separator, treater, process vessel or other installation regulated by Manitoba Regulation 147/84 Governing Oil and Natural Gas Drilling and Production Operations under *The Mines Act*;

(b) domestic quantities of contaminants;

(c) the application of manure onto agricultural land.

Reporting of environmental accidents

3(1) A person who is responsible for or who has custody and control of a contaminant involved in an environmental accident shall immediately after the occurrence of the environmental accident report the accident by calling

(a) the Manitoba Department of Environment and Workplace Safety and Health in Winnipeg at (204) 944-4888; or

(b) the local police or fire department, as appropriate.

3(2) The report referred to in subsection (1) shall include the following information where it is either known or is readily available:

(a) the location and time of the accident;

(b) the name and telephone number of the person reporting the accident;

(c) a brief description of the circumstances of the accident and its status at the time of the report;

c) ceux qui se trouvent dans une quantité ou à un niveau établi à la colonne III de l'annexe.

2(2) Le présent règlement ne s'applique pas

a) aux accidents relatifs à l'environnement lorsqu'il s'agit d'huile ou d'eau salée répandue par suite ou d'une fissure d'un bris qui s'est produit dans une tête de puits, une conduite d'écoulement, un pipeline, un réservoir, un séparateur, un purificateur, un réservoir de transformation ou toute autre installation régie par le *règlement du Manitoba* 147/84 concernant les activités de forage et d'exploitation de puits d'huile et de gaz naturel pris en application de la *Loi sur les mines*;

b) aux quantités domestiques de contaminant;

c) à l'épandage de fumier sur des terres agricoles.

Rapport sur les accidents relatifs à l'environnement

3(1) Toute personne qui est responsable ou chargée de la garde ou de la surveillance d'un contaminant ayant causé un accident relatif à l'environnement doit faire rapport de l'accident sans délai en téléphonant à l'un ou l'autre des organismes suivants:

a) le ministère de l'Environnement et de la Sécurité et de l'hygiène du travail du Manitoba dont le numéro de téléphone est (204) 944-4888;

b) le corps de police ou le poste de pompiers local, selon le cas.

3(2) Le rapport visé au paragraphe (1) doit comprendre les renseignements qui suivent lorsque ceux-ci sont connus ou qu'il est possible de se les procurer :

a) l'endroit et l'heure de l'accident;

b) le nom et le numéro de téléphone de la personne qui fait le rapport sur l'accident;

c) une brève description des circonstances de l'accident et de la situation au moment où le rapport est présenté;

(d) the identity and quantity of the contaminant;

(e) the name of the owner of the contaminant;

(f) the action that the person making the report has taken or intends to take with respect to the accident;

(g) other relevant information required by the person to whom the report is made.

d) la nature du contaminant et la quantité répandue;

e) le nom du propriétaire du contaminant;

f) les mesures que la personne ayant fait le rapport a prises ou a l'intention de prendre relativement à l'accident;

g) tout autre renseignement pertinent dont pourrait avoir besoin la personne à laquelle le rapport est communiqué.

3(3) Where requested to do so by an environment officer, a person referred to in subsection (1) shall file a written report with the department setting out such information as is requested by the environment officer.

3(3) Toute personne visée au paragraphe (1) doit, à la demande d'un agent de l'environnement, déposer auprès du ministère un rapport écrit fournissant tous les renseignements demandés par l'agent de l'environnement.

SCHEDULE
REPORTABLE QUANTITIES

| Column I CLASSIFICATION | Column II HAZARD | Column III REPORTABLE QUANTITY OR LEVEL |
|--|-------------------------------------|---|
| 1 | Explosives | All |
| 2.1 | Compressed Gas (Flammable) | 100 L* |
| 2.2 | Compressed Gas | 100 L* |
| 2.3 | Compressed Gas (Toxic) | All |
| 2.4 | Compressed Gas (Corrosive) | All |
| 3 | Flammable Liquids | 100 L |
| 4 | Flammable Solids | 1 Kg |
| 5.1 Packing Groups I and II Packing Group III | Oxidizer | 1 Kg or 1L |
| 5.2 | Oxidizer | 50 Kg or 50 L |
| 5.2 | Organic Peroxide | 1 Kg or 1 L |
| 6.1 Packing Group I Packing Groups II and III | Acute Toxic | 1 Kg or 1 L |
| 6.2 | Acute Toxic | 5 Kg or 5 L |
| 6.2 | Infectious | All |
| 7 | Radioactive | Any discharge or radiation level exceeding 10 m Sv/h at the package surface and 200 uSv/h at 1 m from the package surface |
| 8 | Corrosive | 5 Kg or 5 L |
| 9.1 | Miscellaneous (except PCB mixtures) | 50 Kg |
| 9.1 | PCB Mixtures | 500 grams |
| 9.2 | Aquatic Toxic | 1 Kg or 1 L |
| 9.3 | Wastes (Chronic Toxic) | 5 kg or 5 L |

* Container Capacity (refers to container water capacity)

The Queen's Printer
for the Province of Manitoba

ANNEXE
QUANTITÉS À DÉCLARER

| Colonne I CLASSIFICATION | Colonne II MATIÈRE DANGEREUSE | Colonne III QUANTITÉ OU NIVEAU À DÉCLARER |
|------------------------------------|---|--|
| 1 | Explosifs | Tous |
| 2.1 | Gaz comprimé (inflammable) | 100 L* |
| 2.2 | Gaz comprimé | 100 L* |
| 2.3 | Gaz comprimé (toxique) | Tous |
| 2.4 | Gaz comprimé (corrosif) | Tous |
| 3 | Liquides inflammables | 100 L |
| 4 | Solides inflammables | 1 kg |
| 5.1 | Matière comburante | 1 kg ou 1 L |
| 5.1 | Groupe d'emballage I et II | |
| 5.1 | Groupe d'emballage III | 50 kg ou 50 L |
| 5.2 | Péroxyde organique | 1 kg ou 1 L |
| 6.1 | Matière à toxicité aiguë | 1 kg ou 1 L |
| 6.1 | Groupe d'emballage I | |
| 6.1 | Groupe d'emballage II et III | 5 kg ou 5 L |
| 6.2 | Matières infectieuses | Toutes |
| 7 | Matières radioactives | Toute émission ou niveau de rayonnement supérieur à 10 mSv/h à la surface de l'emballage et à 200 uSv/h à 1 m de la surface de l'emballage |
| 8 | Matières corrosives | 5 kg ou 5 L |
| 9.1 | Divers | 50 kg |
| 9.1 | (sauf les mélanges de BPC) | |
| 9.1 | Mélanges de BPC | 500 grammes |
| 9.2 | Matières à toxicité aquatique | 1 kg ou 1 L |
| 9.3 | Déchets (à toxicité chronique) | 5 kg ou 5 L |

* Capacité du contenant (s'entend de la quantité d'eau qu'il peut contenir)

L'Imprimeur de la Reine
du Manitoba

SECTION 01 45 16.13

QUALITY CONTROL

PART 1 GENERAL

1.1 CODES AND STANDARDS

- A. In the case of a conflict or discrepancy between the Contract and the governing standards, the more stringent requirements shall apply.
- B. Unless the edition number and date are specified, the reference to published codes, standards, and Specifications are to be the latest edition published by the issuing authority, current at the date of RFP closing.
- C. Reference standards and requirements are quoted in these Specifications to establish minimum standards. Work in quality exceeding these minimum standards conforms to the Contract.
- D. Where reference is made to a Contractor's direction, instruction, or Specification, it is deemed to include full information on storing, handling, preparing, mixing, installing, erecting, applying, or other matters concerning the Goods pertinent to their use and their relationship to the Goods with which they are incorporated.
- E. Where reference is made to regulatory authorities, it includes all authorities who have, within their constituted powers, the right to enforce the laws of the Site.

1.2 TESTING AND QUALITY CONTROL

- A. Provide to the Contract Administrator, when requested and consistent with progress of the Work, test results and designs specified in the Contract or required by by-laws, statutes, and regulations relating to the Work and the preservation of public health, including the following:
 - 1. Inspection and testing performed exclusively for the Contractor's convenience;
 - 2. Testing, adjusting, and balancing of process equipment and systems, conveying equipment and systems, mechanical systems;
 - 3. Mill tests and certificates of compliance;
- B. The Contract Administrator will select and the City will pay for the services of a testing agency or laboratory for material quality control tests that are required but not specified. Tests required by by-laws, statutes, and regulations applicable to the Work are the responsibility of the Contractor. City's tests do not relieve Contractor of his own quality control.
- C. Compliance and performance testing of equipment, pipe, conduit, and other items covered in other Divisions of this specification are the responsibility of the Contractor. The City may replicate any series of tests to provide random checks on the compliance and performance tests at the City's cost.

- D. Remove and replace Goods indicated in inspection and test reports as failing to comply with the Contract.
- E. Pay the costs for re-inspection and re-testing of replaced Work.
- F. It is not the responsibility of the inspection and testing agents to supervise, instruct in current methods or accept or reject a part of the Work, but only to inspect, test, and to report conditions.
- G. Notify the Contract Administrator not less than fourteen (14) days prior to the commencement of the part of the Work to be inspected and tested. The Contract Administrator, at his discretion, may have their inspection and testing agent inspect the Work.
- H. Cooperate with and provide facilities for the inspection and testing agents to perform their duties.
- I. Laboratory test reports to include:
 - 1. Date of issue.
 - 2. Contract name and number.
 - 3. Name and signature of inspector or tester.
 - 4. Date of inspection or test.
 - 5. Identification of the equipment and Specification section covering inspected or tested Work.
 - 6. Location of the inspection or the location from which the tested equipment was derived.
 - 7. Type of inspection or test.
 - 8. The remarks and observations on compliance with the Contract.
- J. Correct defective Work within the schedule stated in the Supplemental Conditions; the performing of such work is not a cause for an extension of the schedule.
- K. City may request samples at any reasonable time. Provide materials for tests as may be required.

1.3 SUBMITTALS

- A. In accordance with Section 01 33 00, Submittal Procedures.

PART 2 PRODUCTS (Not Used)

PART 3 EXECUTION

3.1 SOURCE QUALITY CONTROL

- A. Where Specifications call for factory testing to be witnessed by Contract Administrator, notify Contract Administrator not less than 14 days prior to scheduled test date, unless otherwise specified.

- B. Calibration Instruments: Bear the seal of a reputable laboratory certifying instrument has been calibrated within the previous six (6) months to a standard endorsed by the National Institute of Standards and Technology (NIST).
- C. Metal Work and Welding: Ensure workmanship of the highest quality throughout by employing only metal workers that have demonstrated the highest skills in this type of work and qualified welders certified to weld the materials used in fabrication of the Goods. Comply with Section 05 05 23, Welding – Quality Assurance.
- D. Factory Inspections and Testing: Inspect all components for required construction, electrical connection, and intended function. Perform Contractor's standard inspections and factory testing of equipment and components in addition to any additional testing required under these Specifications.
- E. Mixer Tests and Reports: See Section 46 41 00, Vertical Turbine Mixing Equipment.
- F. Pump Tests and Reports: See Section 43 21 13.29, Centrifugal Pumps or Section 44 42 56.14, Lobe Pumps.
- G. Motor Tests and Reports: See Section 26 20 00, Low Voltage AC Induction Motors.
- H. Blower Tests and Reports: See Section 43 11 33, Rotary Positive Displacement Blower.
- I. Instrumentation Tests and Reports: See Section 40 90 01, Instrumentation & Control Components.

3.2 FIELD QUALITY CONTROL

- A. Furnish paints and finishes as required for Installation Contractor to spot prime bolt heads and nuts, field rivets, field welds and touch up any finishes damaged during shipping and installation.
- B. Furnish zinc rich primer for Installation Contractor to touch up galvanized steel where galvanizing is damaged during installation.
- C. Clarifier Troughs and Weirs: Weirs to be level within plus or minus 3.2 mm
- D. Functional and performance testing of all components in accordance with 01 43 33, Contractor's Field Services and the technical Specifications.

END OF SECTION

SECTION 01 61 00

COMMON PRODUCT REQUIREMENTS

PART 1 GENERAL

1.1 REFERENCES

- A. Canadian Standards Association (CSA):
- B. Manufacturers Standardization Society of the Valves and Fitting Industry:
 - 1. SP-6, Standard Finishes for Contact of Pipe Flanges and Connecting – End Flanges of Valves and Fittings.
- C. National Building Code of Canada (NBCC).
- D. Canadian Electrical Code
- E. National Fire Protection Association (NFPA) 820: Standard for Fire Protection in Wastewater Treatment and Collection Facilities

1.2 DESIGN REQUIREMENTS

- A. Where Contractor design is specified, design of installation, systems, equipment, and components, including supports and anchorages, shall be in accordance with provisions of the 2010 NBCC with the 2011 Manitoba Amendments.
- B. Design equipment, anchorage, and support systems for vertical and lateral loading for post-disaster structures according to requirements of the 2010 NBCC with the 2011 Manitoba Amendments.
- C. Where the Specifications require work to be designed by an engineer, engage a registered professional engineer licensed in the Province of Manitoba to design such work. Calculations and shop drawings shall be stamped by a registered professional engineer, licensed in the Province of Manitoba.
- D. Design equipment to have adequate strength, power and capacity for both continuous and intermittent service for a 30-year service life and 99 percent availability.
- E. Design machinery and system layouts such that working parts are readily accessible for inspection and repair, and that each part is suitable for the service required.
- F. Design non-wetted components for the following conditions:
 - 1. Humid indoor environment with chlorine vapours.
 - 2. Air Temperature: 5 to 40 degrees Celsius.
- G. Notify the Contract Administrator immediately upon discovery of discrepancies or omissions in the Contract or of any doubt as to the meaning or intent of any part thereof.

To proceed with the Work when an error is suspected or when there is doubt as to the interpretation of the project requirements constitutes full acceptance of any cost associated with any remedial work that may be required.

1.3 ENVIRONMENTAL REQUIREMENTS

- A. Provide materials and equipment suitable for installation and operation under rated conditions at 240 m above sea level.
- B. Provide electrical and instrumentation components suitable for Class I, Zone 2, Group IIA classification per the latest version of the Canadian Electrical Code and NFPA 820.

1.4 PREPARATION FOR SHIPMENT

- A. When practical, factory assemble products. Mark or tag separate parts and assemblies to facilitate field assembly. Cover machined and unpainted parts that may be damaged by the elements with strippable protective coating.
- B. Package products to facilitate handling and protect from damage during shipping, handling, and storage. Mark or tag outside of each package or crate to indicate its purchase order number, bill of lading number, contents by name, name of project and Contractor, equipment number, and approximate weight. Include complete packing list and bill of materials with each shipment.
- C. Extra Materials, Special Tools, Test Equipment, and Expendables:
 - 1. Furnish as required by individual Specifications.
 - 2. Schedule:
 - a. Ensure that shipment and delivery occurs concurrent with shipment of associated equipment.
 - b. Transfer to City shall occur immediately subsequent to Installation Contractor's acceptance of equipment from Contractor.
 - 3. Packaging and Shipment:
 - a. Package and ship extra materials and special tools to avoid damage during long term storage in original cartons insofar as possible, or in appropriately sized, hinged-cover, wood, plastic, or metal box.
 - b. Prominently displayed on each package, the following:
 - 1) Contractor's part nomenclature and number, consistent with Operation and Maintenance Manual identification system.
 - 2) Applicable equipment description.
 - 3) Quantity of parts in package.
 - 4. Deliver materials to Site.
 - 5. Notify Contract Administrator upon arrival for transfer of materials.
 - 6. Replace extra materials and special tools found to be damaged or otherwise inoperable at time of transfer to City.
- D. Factory Test Results: Reviewed and accepted by Contract Administrator before shipment as required in individual Specification sections.

1.5 DELIVERY AND INSPECTION

- A. Deliver products in accordance with the Supplemental Conditions.
- B. Deliver products in undamaged condition, in original container or packaging, with identifying labels intact and legible. Include on label, date of manufacture and shelf life, where applicable. Include ULC and CSA labels on products so specified. Packaging of supplied equipment and materials shall be suitable to withstand the storage conditions stated in Contractor's written storage instructions. The Installation Contractor will provide a suitable storage area for temporary storage of the equipment and materials.
- C. Provide unloading instructions to the Contract Administrator and the Installation Contractor. Record receipt of Goods at the Site. Inspect for completeness and evidence of damage during shipment.
- D. Remove damaged products from Site and expedite delivery of identical new undamaged products, and remedy incomplete or lost products to provide that specified, so as not to delay progress of the work.

PART 2 PRODUCTS

2.1 GENERAL

- A. Conform to the City's Operational Technical Standards attached to this Section as a Supplement.
- B. Provide materials and equipment as follows:
 - 1. Current production models of the HRC system and accessories.
 - 2. New in every respect. Reconditioned equipment is not acceptable.
 - 3. Constructed and finished in a workmanlike manner.
 - 4. Suitable for the service intended.
 - 5. Selected, designed and fabricated in accordance with best practices and methods.
- C. Provide Contractor's standard materials suitable for specified service conditions, unless otherwise specified.
- D. Where Specifications include a named manufacturer, with or without model number, and also include performance requirements, named manufacturer's products must meet the performance specifications.
- E. Like items of products furnished in the Work shall be end products of one manufacturer and of the same series or family of models to achieve standardization for appearance, operation and maintenance, spare parts and replacement, manufacturer's services, and implement same or similar process instrumentation and control functions in same or similar manner.

- F. Equipment, Components, Systems, Subsystems: Design and manufacture with due regard for health and safety of operation, maintenance, and accessibility, durability of parts, and shall comply with applicable provincial, and local health and safety regulations.
- G. Regulatory Requirement: Coating materials shall meet federal, provincial, and local requirements limiting the emission of volatile organic compounds and for worker exposure.
- H. Provide materials and equipment listed by ULC and CSA wherever standards have been established by that agency.
- I. Equipment Finish:
 - 1. Provide manufacturer's standard finish and colour, except where specific colours are required by the City's Operational Technical Standards attached to this Section or otherwise required by the Specifications.
 - 2. If manufacturer has no standard color and no colour is otherwise required by the City's Operational Technical Standards or Specifications, provide equipment with gray finish as approved by Contract Administrator.
- J. Special Tools and Accessories: Furnish to City, upon acceptance of equipment, all accessories required to place each item of equipment in full operation. These accessory items include, but are not limited to, adequate oil and grease (as required for first lubrication of equipment after field testing), light bulbs, fuses, hydrant wrenches, valve keys, handwheels, chain operators, special tools, and other spare parts as required for maintenance.
- K. Lubricants:
 - 1. Provide initial lubricant recommended by equipment manufacturer in sufficient quantity to fill lubricant reservoirs and to replace consumption during testing, startup, and operation until final acceptance by Owner.
 - 2. Provide Canadian made lubricants readily available in Canada. To the extent possible, provide lubricants compatible with products currently used in Owner's maintenance operations.
 - 3. Furnish lubricants in original sealed containers, correctly identified as to brand and grade.

2.2 FABRICATION AND MANUFACTURE

- A. General:
 - 1. Manufacture parts to North American standard sizes and gauges.
 - 2. Two or more items of the same type shall be identical, by the same manufacturer, and interchangeable.
 - 3. Design structural members for anticipated shock and vibratory loads.
 - 4. Use 6 mm minimum thickness for steel that will be submerged, wholly or partially, during normal operation.
 - 5. Modify standard products as necessary to meet performance Specifications.
- B. Lubrication System:
 - 1. Require no more than weekly attention during continuous operation.

2. Convenient and accessible. Oil drains with bronze or stainless steel valves and fill-plugs easily accessible from the normal operating area or platform. Locate drains to allow convenient collection of oil during oil changes without removing equipment from its installed position.
3. Provide constant-level oilers or oil level indicators for oil lubrication systems.
4. For grease type bearings, which are not easily accessible, provide and install stainless steel tubing; protect and extend tubing to convenient location with suitable grease fitting.

2.3 ACCESSORIES

- A. Equipment Labeling: Furnish equipment with lamacoids securely mounted in a readily visible location on all equipment in conformance with the City's Operational Technical Standards attached as a Supplement to this Specification.
- B. Lifting Lugs: Provide on equipment weighing over 45 kg.
- C. Anchor Bolts: Furnish Type 316 stainless steel, sized by Contractor, and as specified in Section 05 50 00, Metal Fabrications (Basic).

PART 3 EXECUTION

3.1 SUPPLEMENTS

- A. The supplements listed below, following "End of Section", are part of this Specification.
 1. City of Winnipeg Operational Technical Standards.

END OF SECTION

Operational Technical Standards

Operational Technical standards were created to keep uniformity between the three wastewater treatment plants and assist operations with daily work activities. The operational technical standards are to be included for future design and implementation contracts.

Ancillary Facilities

When building, upgrading or expanding facilities as part the WSTP special consideration is required to match the existing facade of the facilities on site. Where possible, existing site material types and appearances are to be replicated in the detailed design.

Paint Color Codes

All piping within Wastewater treatment facilities are to match the below Sherwin Williams paint codes and color type. Paint products are to be low VOC (Volatile Organic Compound) or water based wherever possible. The following items require uniformity in color and are to be incorporated into the detailed design.

| Item | New Color Name | Sherwin Williams Paint Code | Type |
|-----------------------------|-----------------------|-----------------------------|------------|
| Centrate | Lemon Chiffon | SW 6686 | Interior |
| Chlorine | Solar Yellow | SW 4075 | I&M |
| DAF Subnatant (DSUB) | Springtime | SW 6708 | Interior |
| Digester Gas | Safety Red | SW 4081 | I&M |
| Dry Polymer Storage | Lime Granita | SW 6715 | Interior |
| Fermented Sludge (FSL) | Bengal Grass | SW 6411 | Interior |
| Fermenter Supernatant (FSU) | Wheat Grass | SW 6408 | Interior |
| Ferric Chloride | Solar Yellow | SW 4075 | I&M |
| Final/Secondary Effluent | Emerald Ice | SW 4069 | I&M |
| Flushing Water | Safety Blue | SW 4086 | I&M |
| Glycol Supply | Gala Pink | SW 6579 | Interior |
| Glycol Return | Hibiscus | SW 6851 | Interior |
| Hot Water Supply | Lucky Green | SW 6926 | Interior |
| Hot Water Return | Greenland | MC-29 | Industrial |
| Instrument Air | Shamrock (dark green) | SW 6454 | Interior |
| Liquid Polymer Storage | Lime Rickey | SW 6717 | Interior |
| Mixed Liquor | Extra White | SW 7006 | Interior |
| Natural Gas | Safety Yellow | SW 4084 | I&M |
| Oxygen | Mature Grape | SW 6286 | Interior |
| Potable Water | Vapor (light blue) | MC-85 | Industrial |
| Primary Effluent | Emerald Ice | SW 4069 | I&M |

| Item | New Color Name | Sherwin Williams Paint Code | Type |
|-------------------------------|-----------------------------|-----------------------------|----------|
| Primary Sludge | Iron Ore | SW 7069 | Interior |
| Process Air | Grandview (bluer green) | SW 6466 | Interior |
| Process Drain | Extra White | SW 7006 | Interior |
| Return Activated Sludge | Invigorate (orange) | SW 6886 | Interior |
| Scum/Degreasing | Grays Harbour | SW 6236 | Interior |
| Sludge Cake Hopper | Extra White | SW 7006 | Interior |
| Sludge Cake Line | Overjoy | SW 6689 | Interior |
| Sludge Cake Pump Drive | Festival Green (very green) | SW 6923 | Interior |
| Sludge Cake Storage | Overjoy | SW 6689 | Interior |
| Sludge Feed/Transfer | Curry | SW 6671 | Interior |
| Sludge Mixing System | Navel (kind of pumpkinish) | SW 6887 | Interior |
| Sludge (Trucked) | Toasty | SW 6095 | Interior |
| Thin Sludge | Solaria | SW 6688 | Interior |
| Thickened Bottom Sludge (TBS) | Cityscape | SW 7067 | Interior |
| Thickened Waste (TWAS) | Crispy Gold | SW 6699 | Interior |
| Waste Activated Sludge | Midday (sunny yellow) | SW 6695 | Interior |
| Well Water Supply | Fussy Pink | SW 6853 | Interior |
| Well Water Return | Fussy Pink | SW 6854 | Interior |

Additional items and their corresponding color to consider in the detailed design are listed below:

| Item | New Color Name | Sherwin Williams Paint Code | Type |
|---------------------------|-------------------------|-----------------------------|------------|
| Boilers | Heat Resistant Aluminum | B 59S3 | Industrial |
| Bollards | Safety Red | SW 4081 | I&M |
| Concrete/Blockwork | Cirrus White | SW 4012 | I&M |
| Duct Work | Unusual Gray | SW 7059 | Interior |
| Exterior Pedestals/Panels | Safety Yellow | SW 4084 | I&M |
| Handrails (Painted) | Aluminum | B 59S2 | Industrial |
| Mix Age Polymer Tanks | Outgoing Orange | SW 6641 | Interior |
| Motors | Safety Red | SW 4081 | I&M |
| Motor Bases | Poppy Flower | SW 2904 | Interior |
| Polymer Feed Tanks | Techno Teal | SW 4065 | I&M |
| Rain Water Leaders | Web Gray | SW 7075 | Interior |
| Steel Pipe Supports | Grey | Ansi 61 Grey | |
| Valve Hand/Chainwheels | Safety Red | SW 4081 | I&M |

Confined Space Entry Access

Where access to a confined space is limited a floor mount sleeve for a davit arm should be mounted flush to the floor level, and in optimum areas around the confined space. Multiple locations are to be considered for confined entry access around a tank. **Note:** All flush floor mount davit sleeves are to be capped.

Flush Floor Mount Example: [Flush Floor Mounted Sleeve c/w pins for fresh concrete.](#)



Where a flush mount davit arm sleeve is not possible a Floor Mount or Wall Mount Davit Arm Sleeve could be used.

Floor Mount and Wall Mount Examples: UCL Advanced Floor Mount Sleeve: [DBI SALA model 8516190](#), Wall Mount Sleeve [UCL Advanced Wall Mount Sleeve](#)



Note: The above three examples are for reference; and their specifications should be included into our design standards.

Special considerations:

- 1) Entry Access into a confined spaced should be considered, where feasible guardrails/handrails should be modified to allow easy access.

Example: accessing a primary clarifier by boat, guardrails should be modified to allow entry access.

Fall Restraint

When a confined space is identified anchor points or guardrails should be installed. The anchor points for tie off cannot create a tripping hazard.

Example: sump pump in the middle of a room. To open the hatch you need to tie off to something. If you can't tie off to something then guardrails should be placed around the confined space.

Note: The anchor points or guardrails are in addition to the davit sleeve.

Incorporate the following from **Workplace Safety and Health Regulation 14.14(1)** into the design standards

14.14(1) The owner of a building or structure must ensure that a permanent anchorage system used as the fixed support in a travel restraint system or fall arrest system for that building meets the following requirements:

- a) The anchor has an ultimate capacity of at least 22.2 kN in any direction in which the load may be applied for each worker attached;
- b) The anchorage system is certified by a professional engineer as having the required load capacity.

Safety Signage and Markings

Include the following safety signage and markings in the design standards:

- Directive signs, such as “No Smoking,” “Safety Glasses Required,” “Wear Life Vest,” “Hard Hat Required,” “Hearing Protection Required,”

“Danger—Confined Space,” “Safety Glasses Required,” etc.

- Hazard identification signs indicating dangers such as explosive gases, noise, chemicals, flammables, ice, slippery floors, high pressure vessels, high pressure pipes, overhead utilities, and underground utilities.
- Instructional signs to indicate correct procedures in critical locations and for critical operations or emergencies.
- Signs to limit or restrict access.
- Special equipment bracing where required.
- Wind socks and/or wind vanes

Equipment Accessibility

Plant components should be arranged to provide operating flexibility. Adequate access and removal space should be provided around all components to permit easy maintenance and/or removal and replacement without interfering with the operation of other equipment. Consideration should be given to the need for lifting and handling equipment used in the maintenance and replacement of all components.

Example: Monorail overtop of Bar Screens. The monorail requires an annual inspection however access by scissor lift is not feasible.

Equipment Labeling

Lamacoids will be sized to ensure legibility and able to fit on surface required. However, the default lamacoid label will have black lettering on a white background.

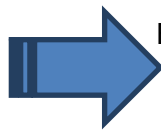
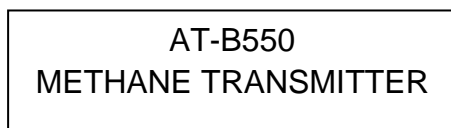

Black Lettering on White Background

Fire Safety Equipment Lamacoids: are to have white lettering on a red background.

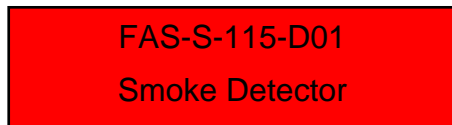

Identification Standard: The Water and Waste Department Identification Standard is to be referenced for consistent and accurate identification for all process, mechanical, electrical, and automation equipment. (Link to standard)

Elevations and Obstacles

There are many changes in elevation, curbs built up to form dykes around equipment, and pipes protruding from the floor. These elevations changes and obstructions may pose potential tripping hazards and should be marked in such a way to alert workers of their presence. This could be achieved by applying reflective tape or painting the curbs yellow.

Such obstacles/tripping hazards should be avoided whenever possible. If not possible should be marked.

Noise Levels Assessment

Area noise levels need to be considered during design and verified as part of commissioning. Designs should limit noise levels to < 85 dB wherever possible.

Eyewash Stations

ANSI Standard Z358.1-2009 specifically requires that the eyewash and shower supply tepid water.

Workplace Safety and Health: “There must be mixing valves to regulate warm and cold water levels in the water flow”.

Note: Some locations might require a recirculating heat pump or a nearby hot water tank to ensure the availability of tepid water.

Outdoor eyewash stations: are to be insulated and heat traced for proper operation.

Facility Lighting

Lighting systems are one of the most visible parts of an electrical system design and therefore one of the most criticized aspects of a design.

Some of the more frequent lighting system design problems are as follows:

- Inadequate or too high light levels.
- Luminaires difficult or impossible to re-lamp.
- Improper choice of light source for various occupancies.
- Use of mercury vapor or similar lamps with long startup times in areas not continuously occupied.
- Exclusive use of mercury vapor or similar lamps with a long restrike time following a momentary power failure in rooms that are continuously occupied.
- Light switches trapped behind doors.

The following operational concerns are to be considered and incorporated into the detailed design with new facilities:

- 1) How is maintenance staff going to perform maintenance on the light fixtures in a safe manner?
- 2) Does the lighting need to be on the ceiling? Operational preference would be to have lighting installed on the side walls where feasible.
- 3) Lighting in stairwells should be on the side walls not on the roof.
- 4) Lighting that requires only 2 hands to maintain is more desirable.

Equipment Safety

Rotating/Reciprocating Machinery and Machine Guarding

- Caps or guards around exposed rotating shafts and all other moving parts (open-mesh type allows equipment viewing without removing guards).
- Guards that are easily replaced and fastened.
- Guards around long, exposed shafts to safeguard the worker from contact or injury from whipping if the shaft breaks.
- Shafts with painted spirals or other markings to indicate running conditions.
- Positive displacement pumps with an air chamber and a pressure switch that will stop the pump at a preset pressure.
- Non-sparking pulleys, belts, and fan wheels used in explosive areas.
- Warning signs on equipment that starts automatically or from a remote location.
- Provisions for local disconnects and lockout-tagout receptacles

Corrosion

Concrete, metals, control and operating equipment, and safety devices should be designed to withstand corrosion.

Example: Dampers exposed to foul air should be corrosion proof

Piping Material

Piping Codes and Standards are to be followed throughout the design process.

- Recent installations of an [Aquatherm](#) product have received favorable reviews from our plant supervisors

Maintenance Facilities

To ensure adequate maintenance of equipment, convenient maintenance facilities should be available. Such facilities generally include a maintenance shop, a garage, storage space, and yard maintenance facilities.

Access to nearby municipal garages and other maintenance centers should be considered. Duplication of facilities should be avoided where possible.

Other Considerations

Overhead Doors

Rubber high speed overhead doors are to be considered in our design standards.

- durability and reliability
- maximum up time and minimal maintenance

Confined Space Labeling and Identification

New confined spaces are to be identified and labeled with a do not enter confined space label. A confined space list is to be provided to the City's Project Manager based on process area.

Example: Primary Clarifier Confined Spaces # 1 and # 2

Confined Space Number: CS-P01, CS-P02



The confined space label utilized by the City of Winnipeg - Water & Waste Department is below:



Note: The intent with this document is providing it to our consultants for guidance when creating our design standards.

Prepared By: _____ Signature: _____

Waste Water Services Division - Document Acceptance

Accepted By: _____ Signature: _____
Superintendent of WW Treatment Plants

SECTION 01 78 23

OPERATION AND MAINTENANCE DATA

PART 1 GENERAL

1.1 SUMMARY

- A. For the guidance of the City's operations and maintenance personnel, the Contractor shall prepare operations and maintenance manuals for the Work, describing in detail each part of the Work and the recommended procedure for operation, servicing, and maintenance.
- B. This section includes detailed information for the preparation, submission, and Contract Administrator's review and approval of operations and maintenance (O&M) manuals, as required by individual Specification sections.
- C. The Contractor shall modify and supplement the manual as required by the Contract Administrator. The Contractor shall make provisions for additions and deletions to the manuals, which may be dictated by the City's operational experience. Where these amendments to the manuals are indicated to be necessary during initial operation before acceptance, the Contractor shall supply the amended sections free of charge.

1.2 DEFINITIONS

- A. Preliminary Data: Initial and subsequent submissions of the O&M manual for Contract Administrator's review.
- B. Final Data: Contract Administrator's-accepted O&M Manual, submitted as specified herein.
- C. Maintenance Operation: As used on Maintenance Summary Form is defined to mean any routine operation required to ensure satisfactory performance and longevity of equipment. Examples of typical maintenance operations include but are not limited to lubrication, belt tensioning, adjustment of pump packing glands, and routine adjustments.
- D. Instructional Manual: An organized compilation of operations and maintenance data including detailed technical information, documents and records describing operation and maintenance of individual systems, subsystems and components as specified in individual sections of this specification.

1.3 SEQUENCING AND SCHEDULING

- A. Preliminary Data: Shall be submitted prior to delivery of the equipment for review and comments by the Contract Administrator.
- B. Final Data: Shall be supplied once the Contract Administrator accepts the O&M Manuals and prior to Total Performance.

1.4 DATA FORMAT

- A. Prepare an Instruction Manual Outline as described in Clause 1.4B. Prepare preliminary data in the form of a Draft Instructional Manual as described in Clause 1.4C. Prepare final data in the form of a Final Instruction Manual as described in Clause 1.4D. Prepare electronic copies of submissions as described in Clause 1.4E.
- B. Instruction Manual Outline Format:
1. Table of Contents:
 - a. A detailed outline of proposed organization and contents of O&M Manual
 - b. Neatly typewritten and arranged in systematic order with consecutive page numbers.
 - c. Identify each product by product name and other identifying numbers or symbols as set forth in Contract.
 2. Size: 8-1/2 inches by 11 inches, minimum.
 3. Cover: Identify manual outline with typed or printed title "DRAFT OPERATION AND MAINTENANCE MANUAL, VOLUME NO. ___ OF ___," and list:
 - a. Project title.
 - b. Contractor's name, address, and telephone number.
 - c. Designate applicable system, equipment, material, or finish.
 - d. Identity of separate structure as applicable.
 - e. Identify volume number if more than one volume.
 - f. Identity of general subject matter covered in manual. Identity of equipment number and Specification section.
- C. Draft Instructional Manual Format:
1. Binder: Commercial quality, permanent, three-ring or three-post binders with durable plastic cover.
 - a. Three hole punch data for binding and composition; arrange printing so that punched holes do not obliterate data
 2. Size: 8-1/2 inches by 11 inches, minimum.
 3. Cover: Identify manual with typed or printed title "DRAFT OPERATION AND MAINTENANCE MANUAL, VOLUME NO. ___ OF ___," and list:
 - a. Project title.
 - b. Contractor's name, address, and telephone number.
 - c. Designate applicable system, equipment, material, or finish.
 - d. Identity of separate structure as applicable.
 - e. Identify volume number if more than one volume.
 - f. Identity of general subject matter covered in manual. Identity of equipment number and Specification section.
 4. Spine:
 - a. Project title.
 - b. Identify volume number if more than one volume.
 5. Title Page:
 - a. Contractor name, address, and telephone number.

- b. Subcontractor, Supplier, installer, or maintenance contractor's name, address, and telephone number, as appropriate.
 - 1) Identify area of responsibility of each.
 - 2) Provide name and telephone number of local source of supply for parts and replacement.
 6. Table of Contents:
 - a. Neatly typewritten and arranged in systematic order with consecutive page numbers.
 - b. Identify each product by product name and other identifying numbers or symbols as set forth in the Contract.
 7. Paper: 20-pound minimum, white for typed pages.
 8. Text: Contractor's printed data, or neatly typewritten.
 9. Three-hole punch data for binding and composition; arrange printing so that punched holes do not obliterate data.
 10. Material shall be suitable for reproduction, with quality equal to original. Photocopying of material will be acceptable, except for material containing photographs.
 11. Additional instruction regarding format, numbering, colours, will be given prior to the submission of the final O&M manual.
- D. Final Instructional Manual Format:
1. Compile all Contract Administrator-accepted preliminary O&M data into a set.
 2. Each set shall consist of the following:
 - a. Binder: Commercial quality, permanent, three-ring or three-post binders with durable plastic cover.
 - b. Cover: Identify each volume with typed or printed title "OPERATION AND MAINTENANCE MANUAL, VOLUME NO. ___ OF ___", and list:
 - 1) Project title.
 - 2) Contractor's name, address, and telephone number.
 - 3) If entire volume covers equipment or system provided by one Supplier include the following:
 - a) Identity of general subject matter covered in manual.
 - b) Identity of equipment number and Specification section.
 - c. Provide each volume with title page and typed table of contents with consecutive page numbers. Place contents of entire set, identified by volume number, in each binder.
 - d. Table of contents neatly typewritten, arranged in a systematic order:
 - 1) Include list of each product, indexed to content of each volume.
 - 2) Designate system or equipment for which it is intended.
 - 3) Identify each product by product name and other identifying numbers or symbols as set forth in the Contract.
 - e. Section Dividers:
 - 1) Heavy, 80 pound cover weight, tabbed with numbered plastic index tabs.

- 2) Fly-Leaf:
 - a) For each separate product, or each piece of operating equipment, with typed description of product and major component parts of equipment.
 - b) List with Each Product:
 - (1) Name, address, and telephone number of Subcontractor, Supplier, installer, and maintenance contractor, as appropriate.
 - (2) Identify area of responsibility of each.
 - (3) Provide local source of supply for parts and replacement.
 - c) Identity of separate structure as applicable.
 - f. Assemble and bind material, as much as possible, in same order as specified in the the Contract.
- E. Electronic Media Format:
1. Furnish in accordance with Section 01 33 00, Submittal Procedures.
 2. Electronic files to be exact duplicates of corresponding hardcopy.
- F. Compact disk (CD) Format:
1. Furnish the Final Instruction Manual electronic files also on CD.
 2. Each hard copy binder shall have one CD affixed to the inside front cover of the binder that contains the electronic version of the binder.
 3. CD Cover: Identify with typed or printed title identical to the hardcopy and list:
 - a. Project title.
 - b. Contractor's name, address, and telephone number.

1.5 SUBMITTALS

- A. Submittals:
1. Data Outline: Submit one electronic copy for Contract Administrator's review prior to preparation of preliminary data.
 - a. Contract Administrator will return comments to Contractor for incorporation into the preparation of preliminary data.
 - b. Contract Administrator's comments will be retained in Contract Administrator's file.
 2. Preliminary Data:
 - a. Submit one electronic copy and three (3) hard copies for Contract Administrator's review.
 - b. If data is accepted by the Contract Administrator:
 - 1) One copy will be returned to Contractor.
 - 2) One copy will be forwarded to the City.
 - 3) One copy will be retained in Contract Administrator's file.
 - c. If data is not accepted by the Contract Administrator:
 - 1) All copies will be returned to Contractor with Contract Administrator's comments (on separate document) for revision.
 - 2) Contract Administrator's comments will be retained in Contract Administrator's file.

- 3) Resubmit revised copies in accordance with Contract Administrator's comments.
3. Final Data: Submit one electronic copy and six (6) hard copies with associated CDs in the format specified herein.

1.6 DATA FOR EQUIPMENT AND SYSTEMS

- A. Content For Each Unit (or Common Units) and System:
 1. Product Data:
 - a. Include only those sheets that are pertinent to specific product.
 - b. Clearly annotate each sheet to:
 - 1) Identify specific product(s) or part(s) installed.
 - 2) Identify data applicable to installation.
 - 3) Delete references to inapplicable information.
 - c. Function, normal operating characteristics, and limiting conditions.
 - d. Serial Numbers
 - e. Performance curves, engineering data, nameplate data, and tests reports for all pumps.
 - f. Complete nomenclature and commercial number of replaceable parts.
 - g. Original manufacturer's parts list, illustrations, detailed assembly drawings showing each part with part numbers and sequentially numbered parts list, and diagrams required for maintenance.
 - h. Spare parts ordering instructions.
 - i. Where applicable, identify installed spares and other provisions for future work (e.g., reserved panel space, unused components, wiring, terminals).
 2. As-installed, color-coded piping diagrams.
 3. Charts of valve tag numbers, with the location and function of each valve.
 4. Drawings: Supplement product data with drawings as necessary to clearly illustrate:
 - a. Format:
 - 1) Provide reinforced, punched, binder tab; bind in with text.
 - 2) Reduced to 8-1/2 inches by 11 inches, or 11 inches by 17 inches folded to 8-1/2 inches by 11 inches.
 - 3) Where reduction is impractical, fold and place in 8-1/2-inch by 11-inch envelopes bound in text.
 - 4) Identify Specification section and product on Drawings and envelopes.
 - b. Relations of component parts of equipment and systems.
 - c. Control and flow diagrams.
 - d. Coordinate drawings with Project record documents to assure correct illustration of completed installation.
 5. Instructions and Procedures: Within text, as required to supplement product data.
 - a. Format:
 - 1) Organize in consistent format under separate heading for each different procedure.
 - 2) Provide logical sequence of instructions for each procedure.

- 3) Provide information sheet for City's personnel, including:
 - a) Proper procedures in event of failure.
 - b) Instances that might affect validity of guarantee or Bond.
 - b. Installation Instructions: Including alignment, adjusting, calibrating, and checking.
 - c. Operating Procedures:
 - 1) Startup, break-in, routine, and normal operating instructions.
 - 2) Test procedures and results of factory tests where specified.
 - 3) Regulation, control, stopping, and emergency instructions.
 - 4) Description of operation sequence by control manufacturer.
 - 5) Shutdown instructions for both short and extended duration.
 - 6) Summer and winter operating instructions, as applicable.
 - 7) Safety precautions.
 - 8) Special operating instructions.
 - d. Maintenance and Overhaul Procedures:
 - 1) Routine maintenance.
 - 2) Guide to troubleshooting.
 - 3) Disassembly, removal, repair, reinstallation, and re-assembly.
- B. Maintenance Summary:
1. Compile individual Maintenance Summary Forms for each applicable equipment item, respective unit or system, and for components or sub-units.
 2. Format:
 - a. Use Maintenance Summary Form attached to this Section or electronic facsimile of such.
 - b. Each Maintenance Summary Form may take as many pages as required.
 - c. Use only 8-1/2-inch by 11-inch size paper.
 - d. Complete using typewriter or electronic printing.
 3. Include detailed lubrication instructions and diagrams showing points to be greased or oiled; recommend type, grade, and temperature range of lubricants and frequency of lubrication.
 4. Recommended Spare Parts:
 - a. Data to be consistent with manufacturer's bill of materials/parts list furnished in O&M manuals.
 - b. "Unit" is the unit of measure for ordering the part.
 - c. "Quantity" is the number of units recommended.
 - d. "Unit Cost" is the current purchase price.

1.7 DATA FOR MATERIALS AND FINISHES

- A. Content for Products, Applied Materials, and Finishes:
1. Manufacturer's data, giving full information on products:
 - a. Catalog number, size, and composition.
 - b. Color and texture designations.
 - c. Information required for reordering special-manufactured products.
 2. Instructions for Care and Maintenance:
 - a. Manufacturer's recommendation for types of cleaning agents and methods.

- b. Cautions against cleaning agents and methods that are detrimental to product.
 - c. Recommended schedule for cleaning and maintenance.
- B. Content for Moisture Protection and Weather Exposed Products:
- 1. Manufacturer's data, giving full information on products:
 - a. Applicable standards.
 - b. Chemical composition.
 - c. Details of installation.
 - 2. Instructions for inspection, maintenance, and repair.

PART 2 PRODUCTS (Not Used)

PART 3 EXECUTION (Not Used)

3.1 SUPPLEMENTS

- A. The supplements listed below, following "End of Section", are part of this Specification.
 - 1. Forms: Maintenance Summary Form.

END OF SECTION

