

V:\Traffic Signals\7. Projects\Coordination\Product Specification\_Designs\New folder\S-SD-03\_Attachment Configurations 10, 15, 18.dwg

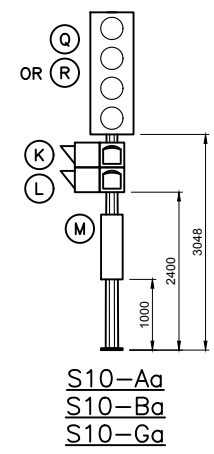

S10-Aa  
S10-Ba  
S10-Ga

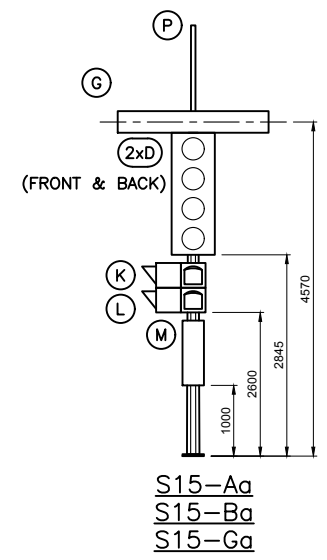

S15-Aa  
S15-Ba  
S15-Ga

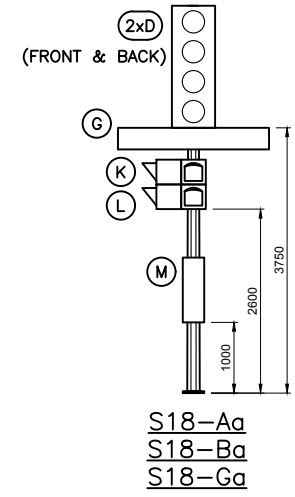

S18-Aa  
S18-Ba  
S18-Ga

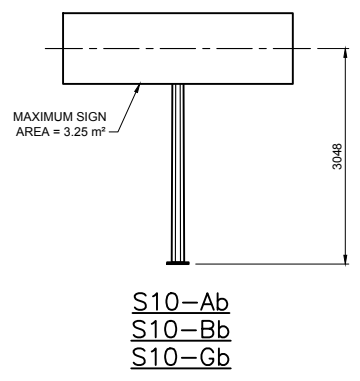

S10-Ab  
S10-Bb  
S10-Gb

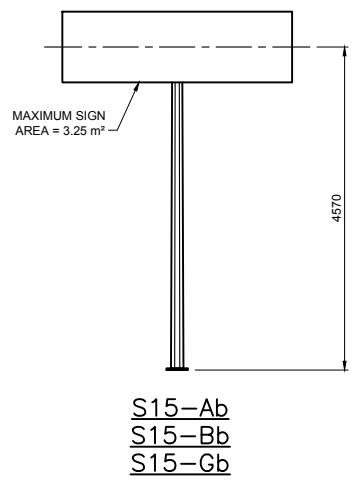

S15-Ab  
S15-Bb  
S15-Gb

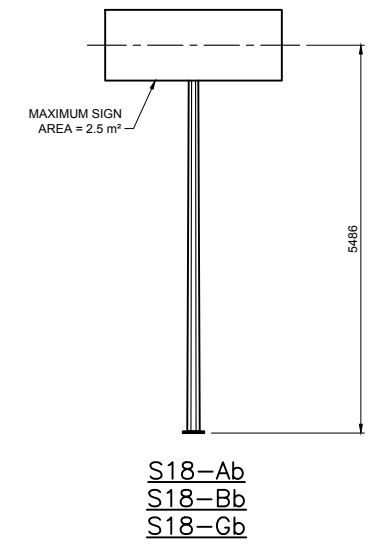

S18-Ab  
S18-Bb  
S18-Gb

**ATTACHMENT CONFIGURATION NOTES:**  
1. CONFIGURATIONS SHOWN TO BE INSTALLED ON TYPE A, B, or G-T BREAKAWAY BASE.  
2. REFER TO SHEET 2 FOR ATTACHMENT DATA.

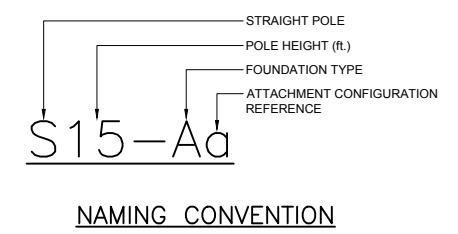

REDUCED DRAWING  
N.T.S.

DESIGNED BY: CDW				<b>THE CITY OF WINNIPEG</b> PUBLIC WORKS DEPARTMENT	
DRAWN BY: JGW				ATTACHMENT CONFIGURATIONS FOR STRAIGHT POLES 10', 15' & 18'	
CHECKED BY: SSR		RELEASED FOR CONSTRUCTION DATE:	CONSULTANT PROJECT NUMBER 12-5954	CITY DRAWING NUMBER S-SD-03	
APPROVED BY: -				SHEET 3 OF 17 CONSULTANT DRAWING NUMBER N/A	
HOR. SCALE: NTS					
VERTICAL: NTS					
NO. REVISIONS		DATE BY			
1 ISSUED BY DILLON CONSULTING		1/10/14 CDW			