

1 **Module G07**
Scale: 1" = 1'-0"

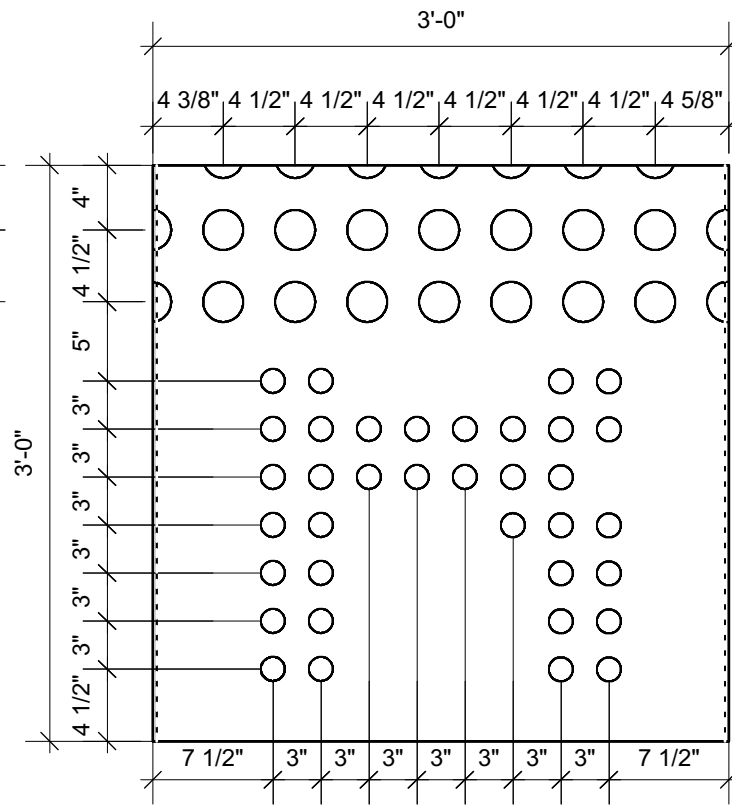

2 **Module G08**
Scale: 1" = 1'-0"

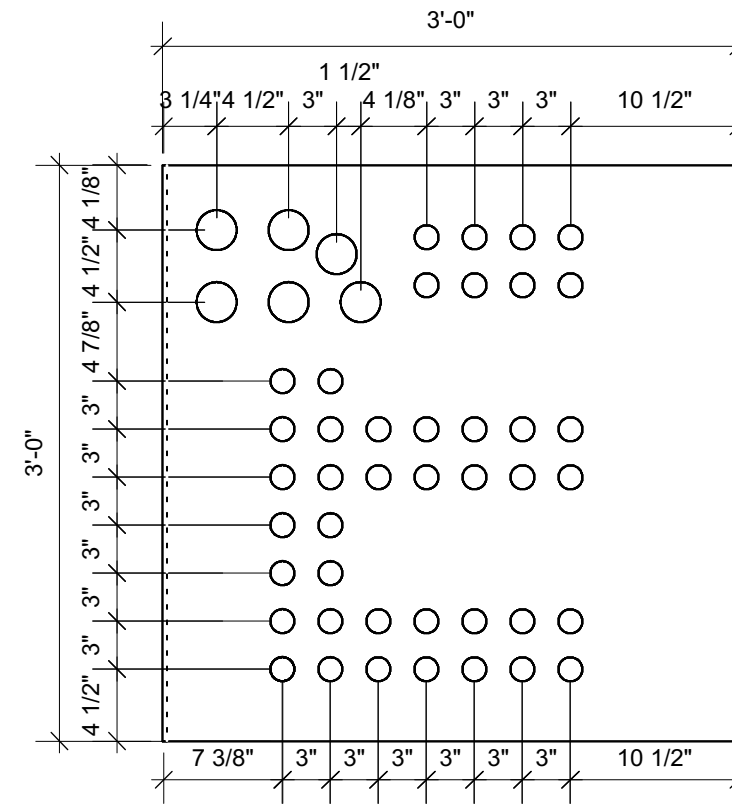

3 **Module G09**
Scale: 1" = 1'-0"

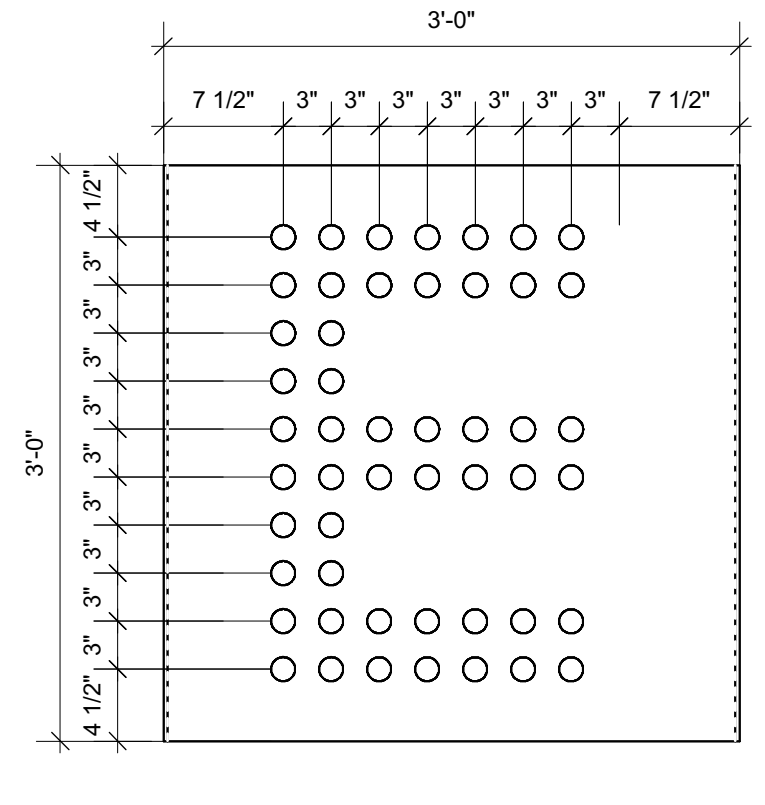

4 **Module G10**
Scale: 1" = 1'-0"

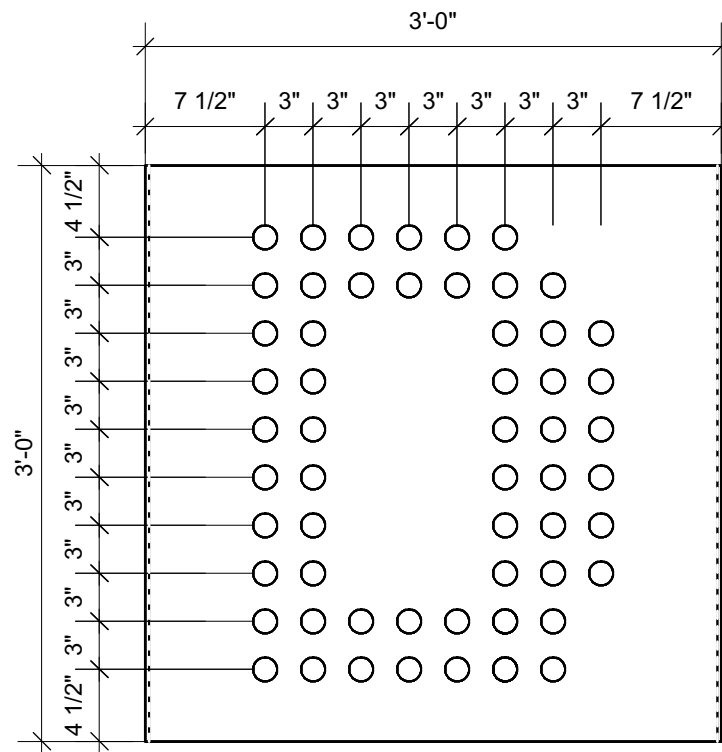

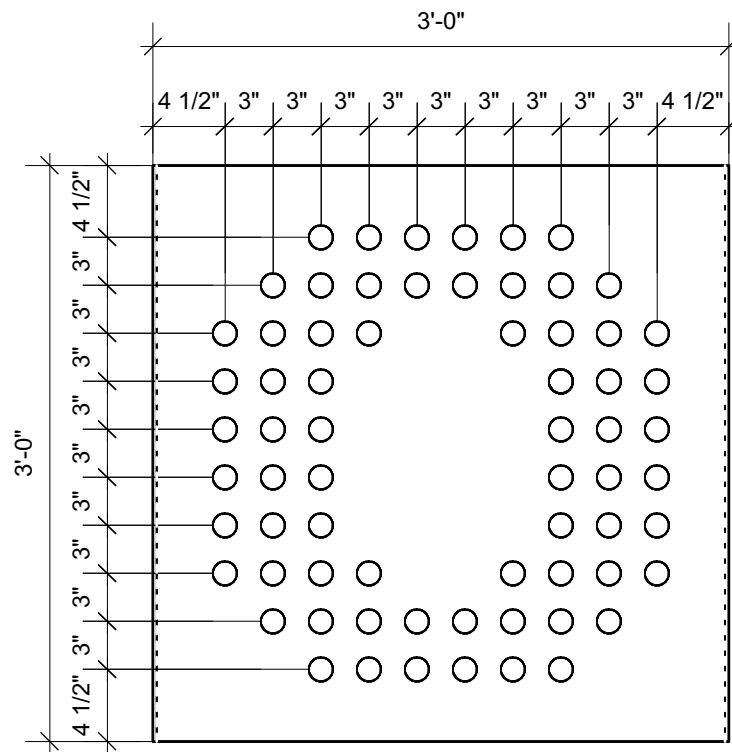

5 **Module G11**
Scale: 1" = 1'-0"

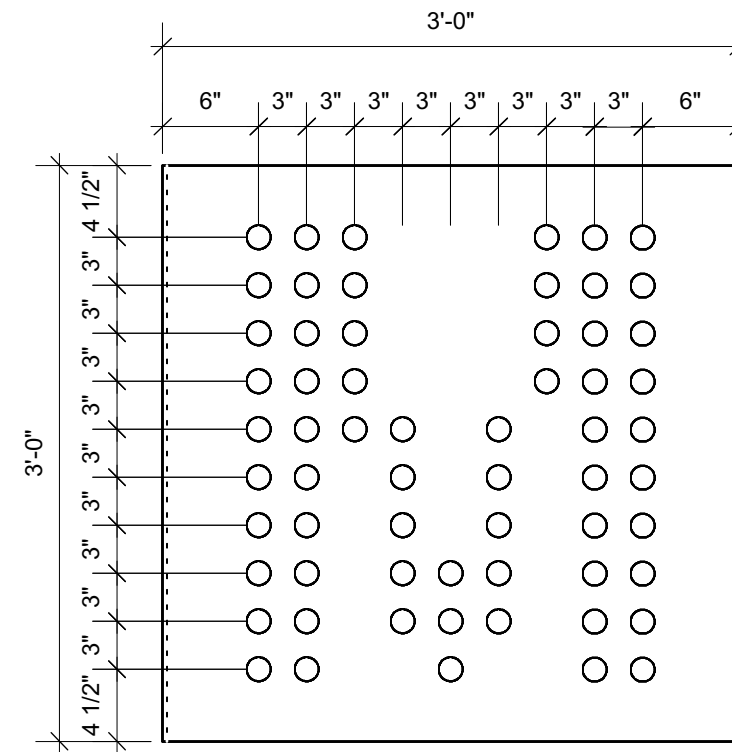

6 **Module G12**
Scale: 1" = 1'-0"



7 **Module G13**
Scale: 1" = 1'-0"

-  Brass rivets $\phi=1\ 1/2"$
(see drawing A7.1)
-  Holes $\phi=2\ 1/2"$

DRAWING A7.14 ADDED - 2017/01/09
ISSUED FOR CONSTRUCTION 2016/11/28
ISSUED FOR PRICING 2016/10/20

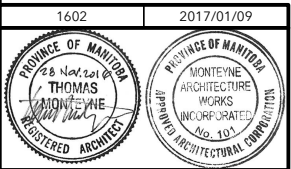

1919 MARQUEE
Winnipeg, Manitoba
Intersection Lily St & Market Ave
MODULES G07 TO G13